

CEE: 4850 Project Design & Management  
 Department of Civil & Environmental Engineering  
 University of Iowa  
 Agency St. Trail Project  
 West Burlington, Iowa

PROJECT: CEE: 4850  
 DATE: 11/18/2024  
 DRAWN BY: B. Misfeldt & E. Oelmann  
 REVISION:

THE UNIVERSITY OF IOWA  
 CIVIL AND ENVIRONMENTAL ENGINEERING  
 4105 SEAMANS CENTER FOR THE  
 ENGINEERING ARTS AND SCIENCES  
 103 S CAPITOL ST  
 IOWA CITY, IOWA 52242  
 PHONE: 319.335.5647  
 FAX: 319.335.5660  
 EMAIL: civil-hawks@iowa.edu



EDUCATIONAL - NOT FOR CONSTRUCTION

**Agency St. Trail Project**  
 122 Broadway St.  
 West Burlington, IA 52655

Sheet Series	Index of Sheets
A	Title Sheets
B	Typical Cross Sections & Details Sheets
C	Quantity Sheets
D	Plan & Profile Sheets



Total Costs	
Entity	Cost
Agency St. Trail	\$358500.00
Broadway St. Trail	\$202500.00
Mall Trail	\$13000.00
Construction Subtotal	\$574000.00
Easements & Property Acquisition	TBD
10% Contingencies	\$57400.00
20% Engineering & Administration	\$114800.00
<b>Total Project Cost</b>	<b>\$746200.00</b>

Intersection & Crosswalk Material Quantities			
	Agency St. Trail	Broadway St. Trail	Mall Trail
Number of 10' x 2' Markings (Unit)	115	82	0
Number of 6' x 2' Markings (Unit)	26	0	14
Total Stop Bars (LF with 2' Width)	137	64	40
Pavement Markings (LF with 1' Width)	2886	1768	248
Pavement Markings Removed (LF)	362	92	84
Number of Stand-Alone Pedestrian Push Buttons (Unit)	6	1	0
Symbols Removed (Unit)	4	3	0
Symbols Added (Unit)	4	3	0

Trail Material Quantities			
	Agency St. Trail	Broadway St. Trail	Mall Trail
Cut (CY)	216.1	83.2	11.5
Fill (CY)	418.5	138.8	6.3
PCC (CY)	892.3	531.6	33.4
Base (CY)	892.3	531.6	33.4
6" PCC (SF)	48186.4	28705.9	1805.2
6" Granular Base (SF)	48186.4	28705.9	1805.2
10' Wide Trail (LF)	4793.7	2646.2	0.0
5' Wide Trail (LF)	49.9	448.9	361.0
Corridor Surface Area (SF)	61185.9	31646.6	2537.0
Corridor Surface Area (Acres)	1.41	0.73	0.06

SHEET NAME  
 Title Sheet

SHEET NO.  
**A-01**

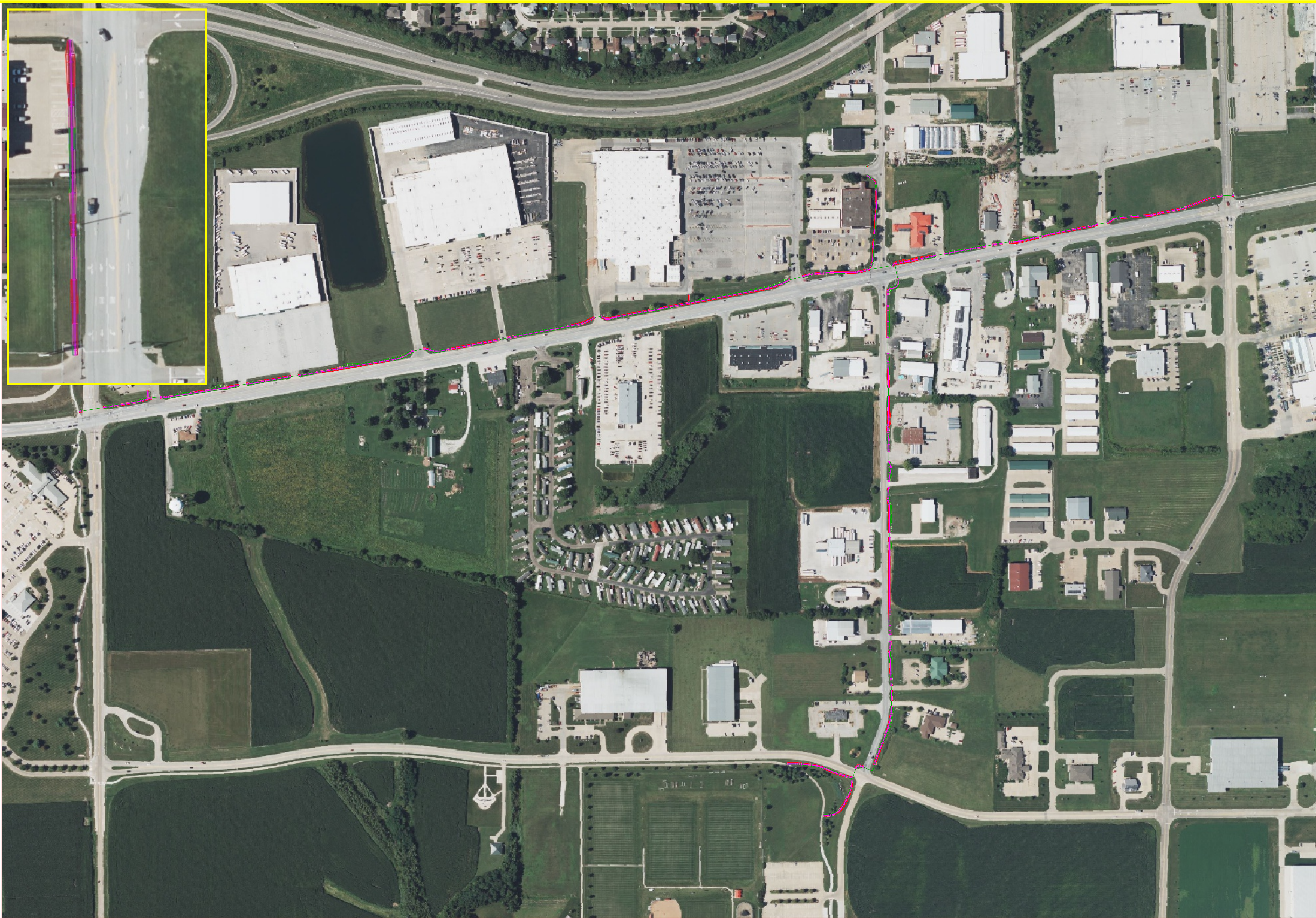

PROJECT: CEE: 4850  
 DATE : 11/18/24  
 DRAWN BY: Blake Mistfeldt  
 REVISION:

**THE UNIVERSITY OF IOWA**  
**CIVIL AND ENVIRONMENTAL ENGINEERING**  
 4105 SEAMANS CENTER FOR THE  
 ENGINEERING ARTS AND SCIENCES  
 103 S CAPITOL ST  
 IOWA CITY, IOWA 52242  
 PHONE: 319.335.5647  
 FAX: 319.335.5660  
 EMAIL: civil-hawks@iowa.edu



EDUCATIONAL - NOT  
 FOR CONSTRUCTION

**Agency St. Trail Project**  
 122 Broadway St.  
 West Burlington, IA 56255

SHEET NAME  
 Project  
 Overview

SHEET NO.  
**A-02**

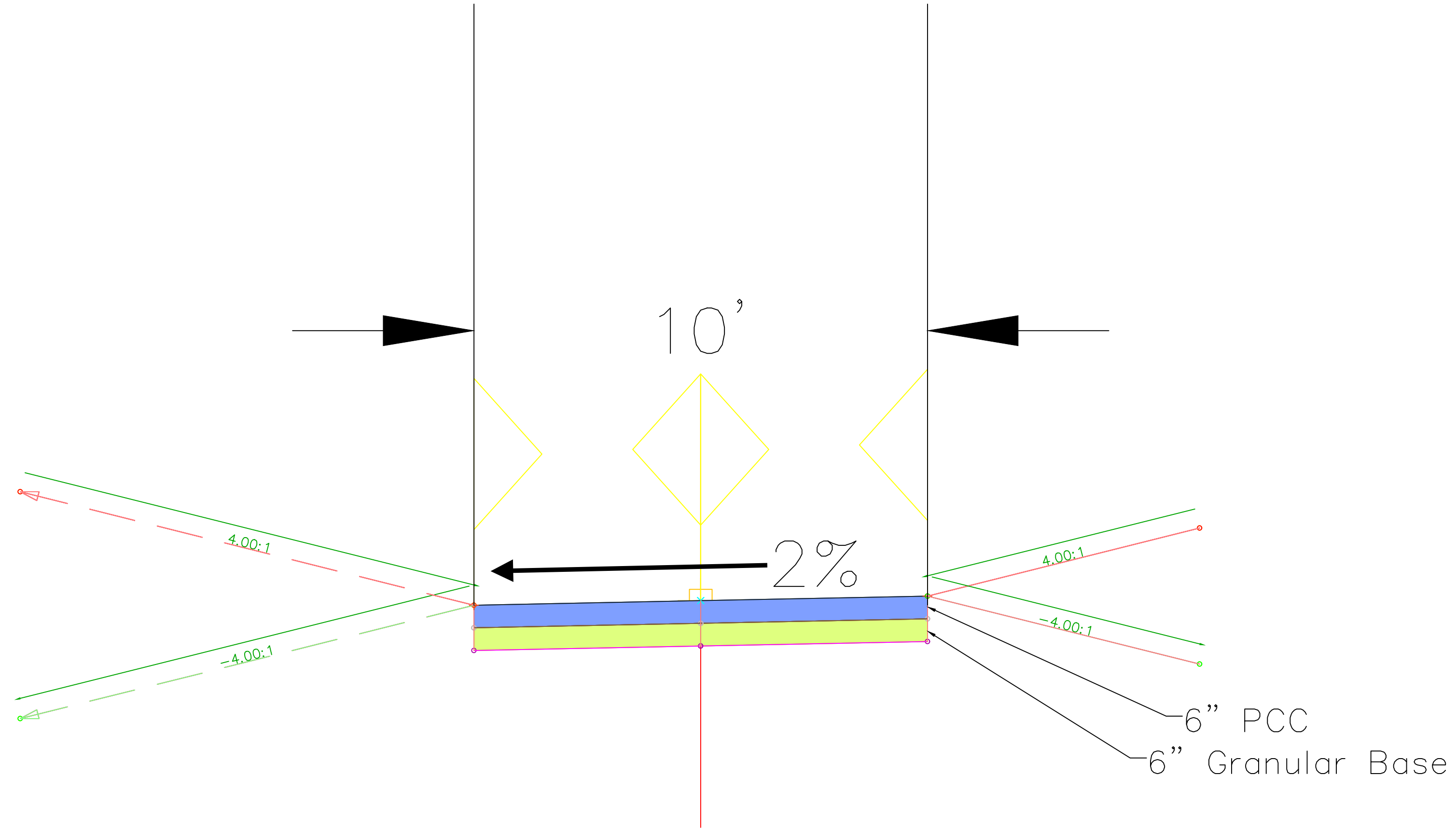
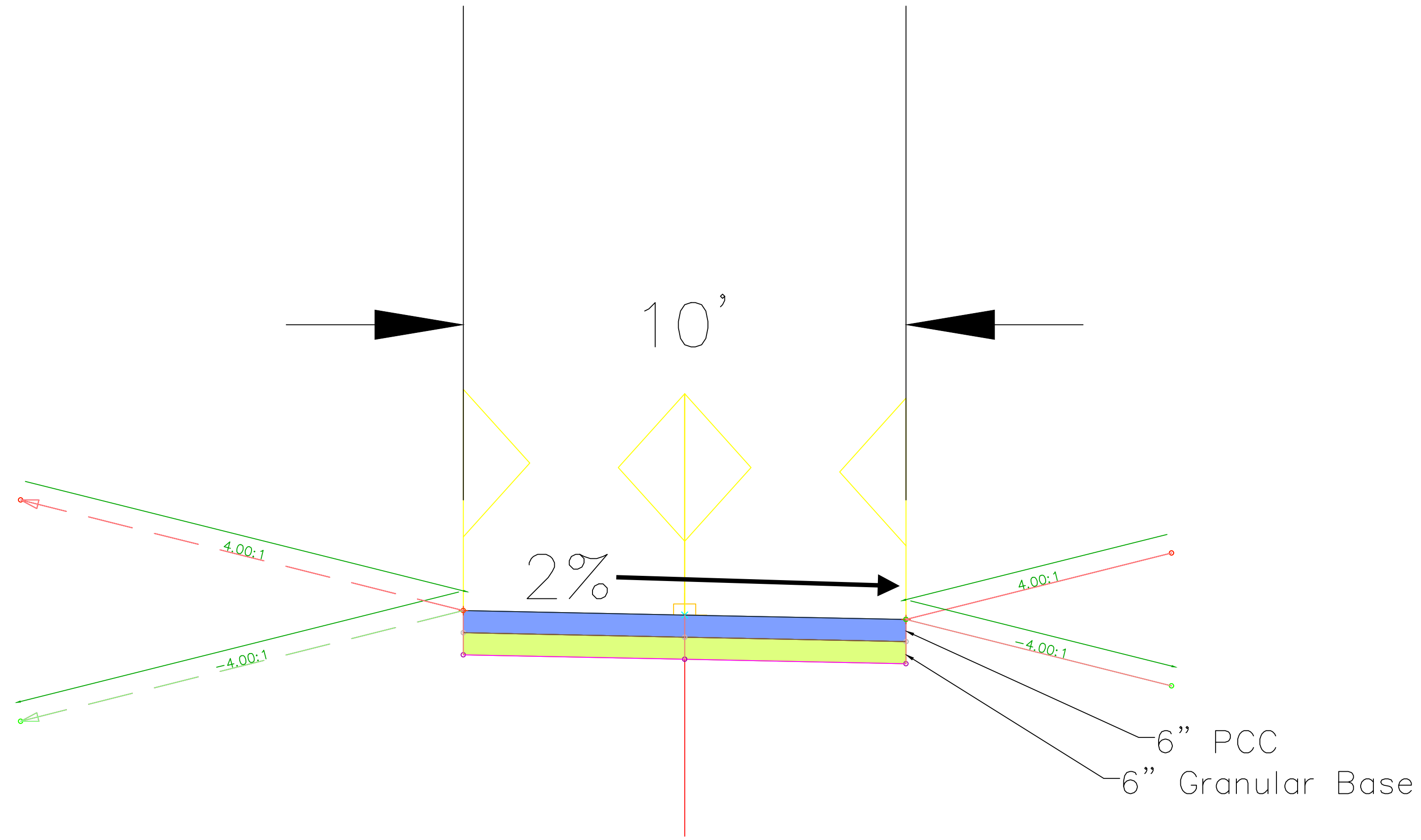

PROJECT:	CEE: 4850
DATE :	11/18/2024
DRAWN BY:	Bieke Misfeldt
REVISION:	

**THE UNIVERSITY OF IOWA**  
**CIVIL AND ENVIRONMENTAL ENGINEERING**  
 4105 SEAMANS CENTER FOR THE  
 ENGINEERING ARTS AND SCIENCES  
 103 S CAPITOL ST  
 IOWA CITY, IOWA 52242  
 PHONE: 319.335.5647  
 FAX: 319.335.5660  
 EMAIL: civil-hawks@iowa.edu



EDUCATIONAL - NOT  
FOR CONSTRUCTION

**Agency St. Trail Project**

122 Broadway St.  
West Burlington, IA 52655

SHEET NAME  
 Typical 10' Sidewalk  
 Cross Sections

SHEET NO.  
**B-01**

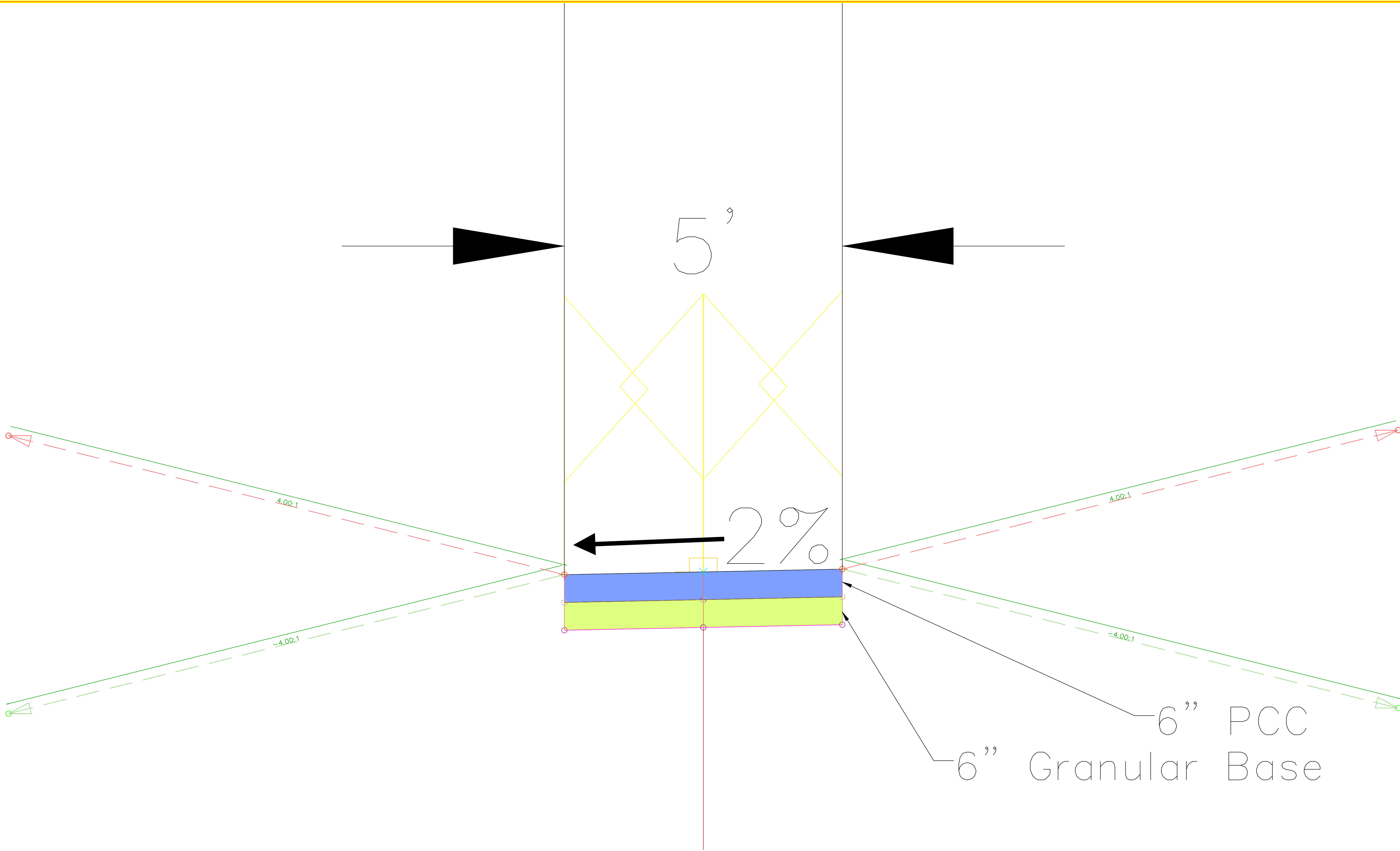

PROJECT:	CEE: 4850
DATE :	11/18/2024
DRAWN BY:	Bieke Misfeldt
REVISION:	

**THE UNIVERSITY OF IOWA**  
**CIVIL AND ENVIRONMENTAL ENGINEERING**  
 4105 SEAMANS CENTER FOR THE  
 ENGINEERING ARTS AND SCIENCES  
 103 S CAPITOL ST  
 IOWA CITY, IOWA 52242  
 PHONE: 319.335.5647  
 FAX: 319.335.5660  
 EMAIL: civil-hawks@iowa.edu



EDUCATIONAL - NOT  
 FOR CONSTRUCTION

**Agency St. Trail Project**  
 122 Broadway St.  
 West Burlington, IA 52655

SHEET NAME  
 Typical 5' Sidewalk  
 Cross Section

SHEET NO.  
**B-02**

FIGURE 7030.204 SHEET 1 OF 1

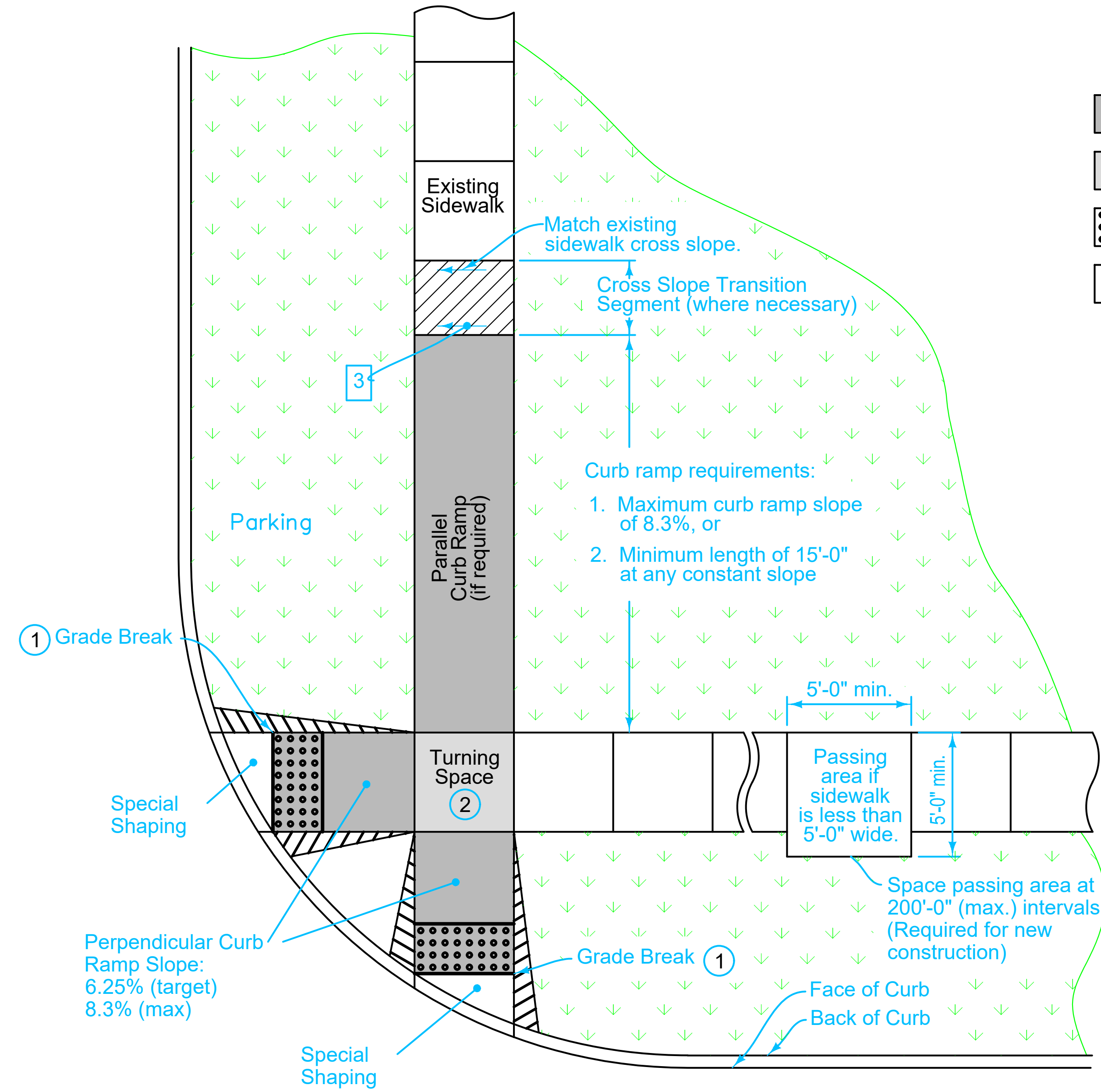

Key

	Curb Ramp
	Turning Space
	Detectable Warning
	Grass

- Match pedestrian street crossing slope, or flatter.
- Minimum 4 feet by 4 feet. Target cross slope of 1.5% with a maximum cross slope of 2.0%.
- Target cross slope of 1.5% with a maximum cross slope of 2.0%.

	REVISION
	3   10-20-15
	<b>7030.204</b>
SHEET 1 of 1	
SUDAS Standard Specifications	
GENERAL FEATURES OF AN ACCESSIBLE SIDEWALK	

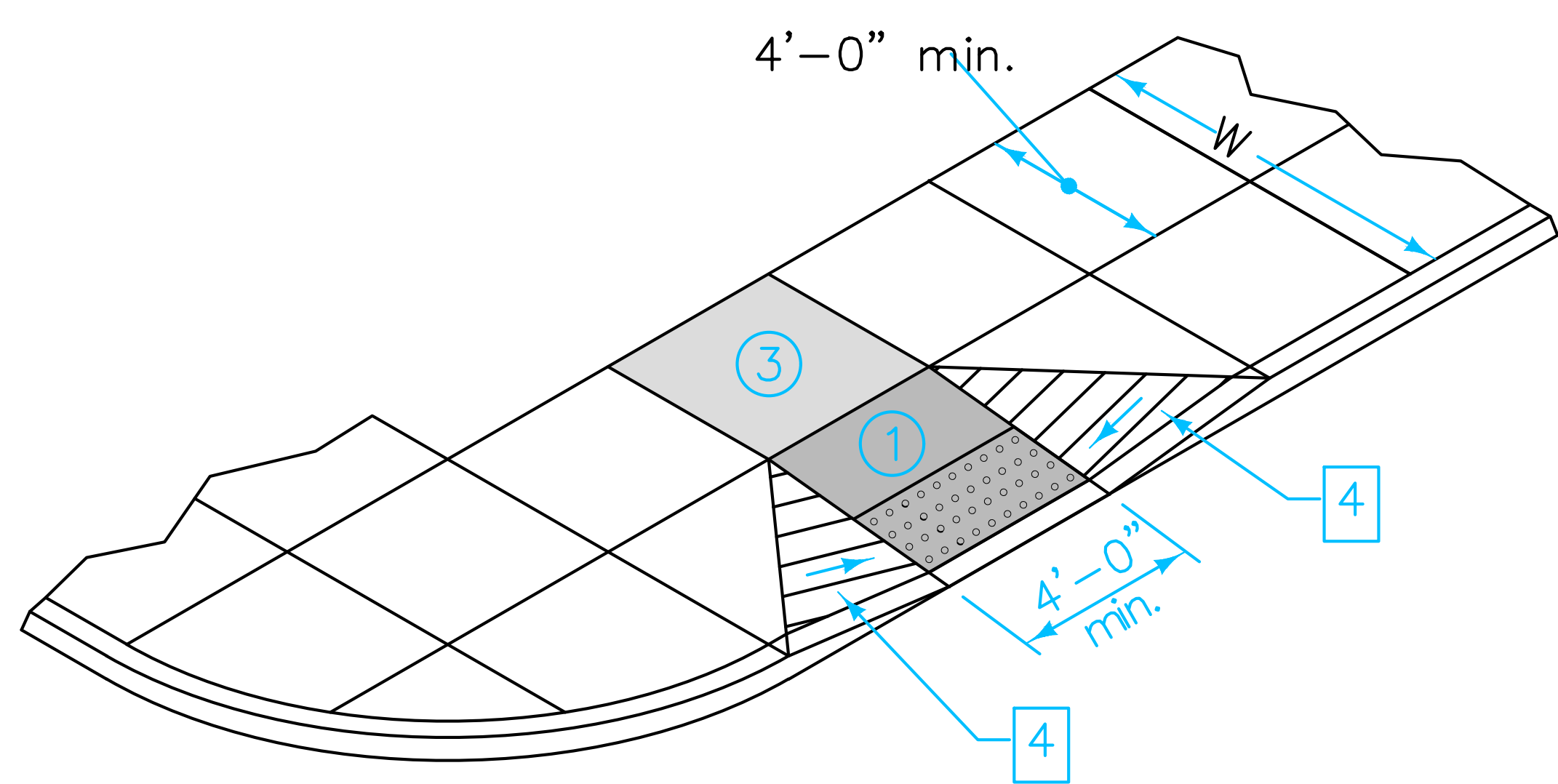

PERPENDICULAR CURB RAMP  
(For Class A Sidewalk)

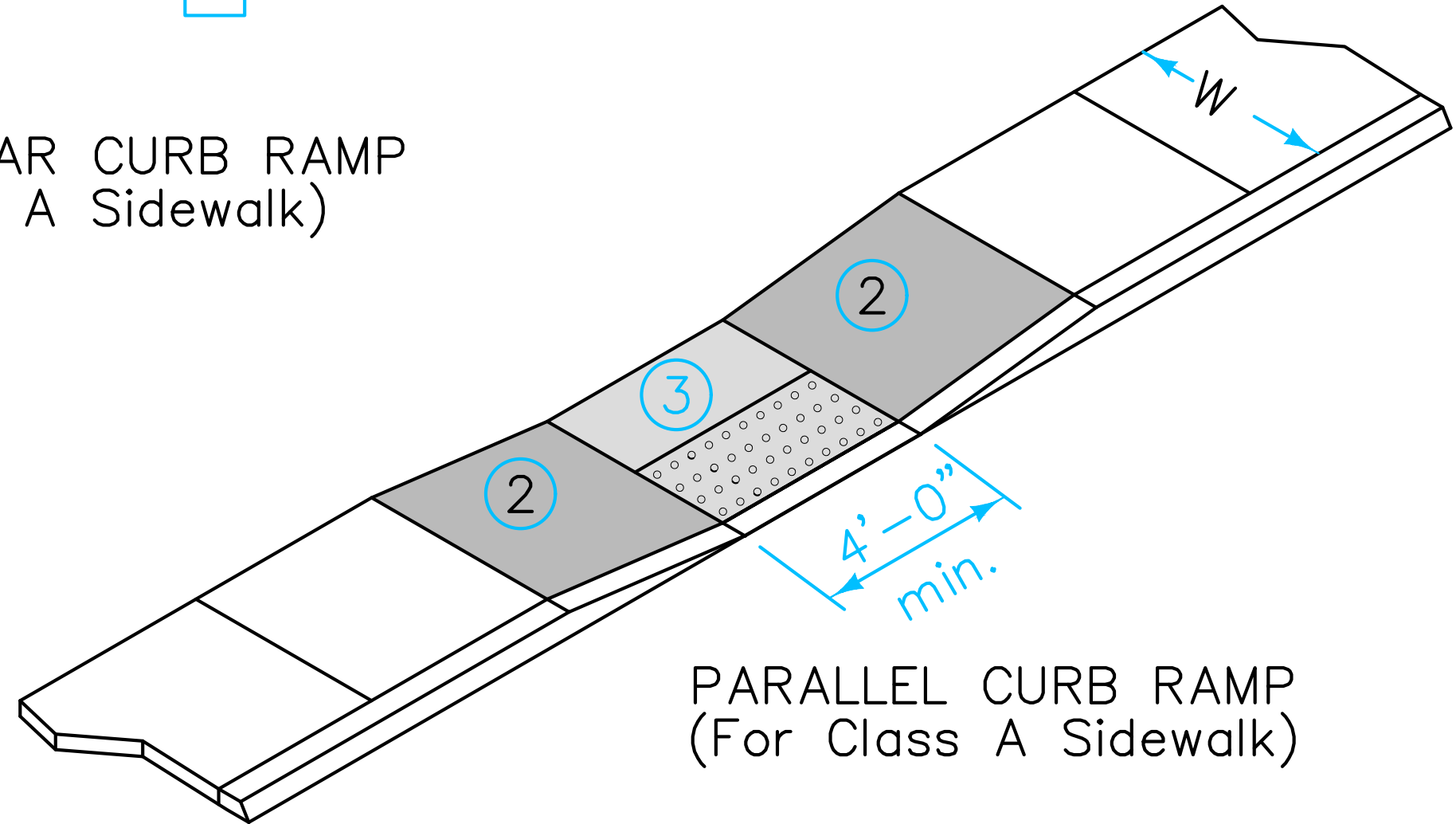

PARALLEL CURB RAMP  
(For Class A Sidewalk)

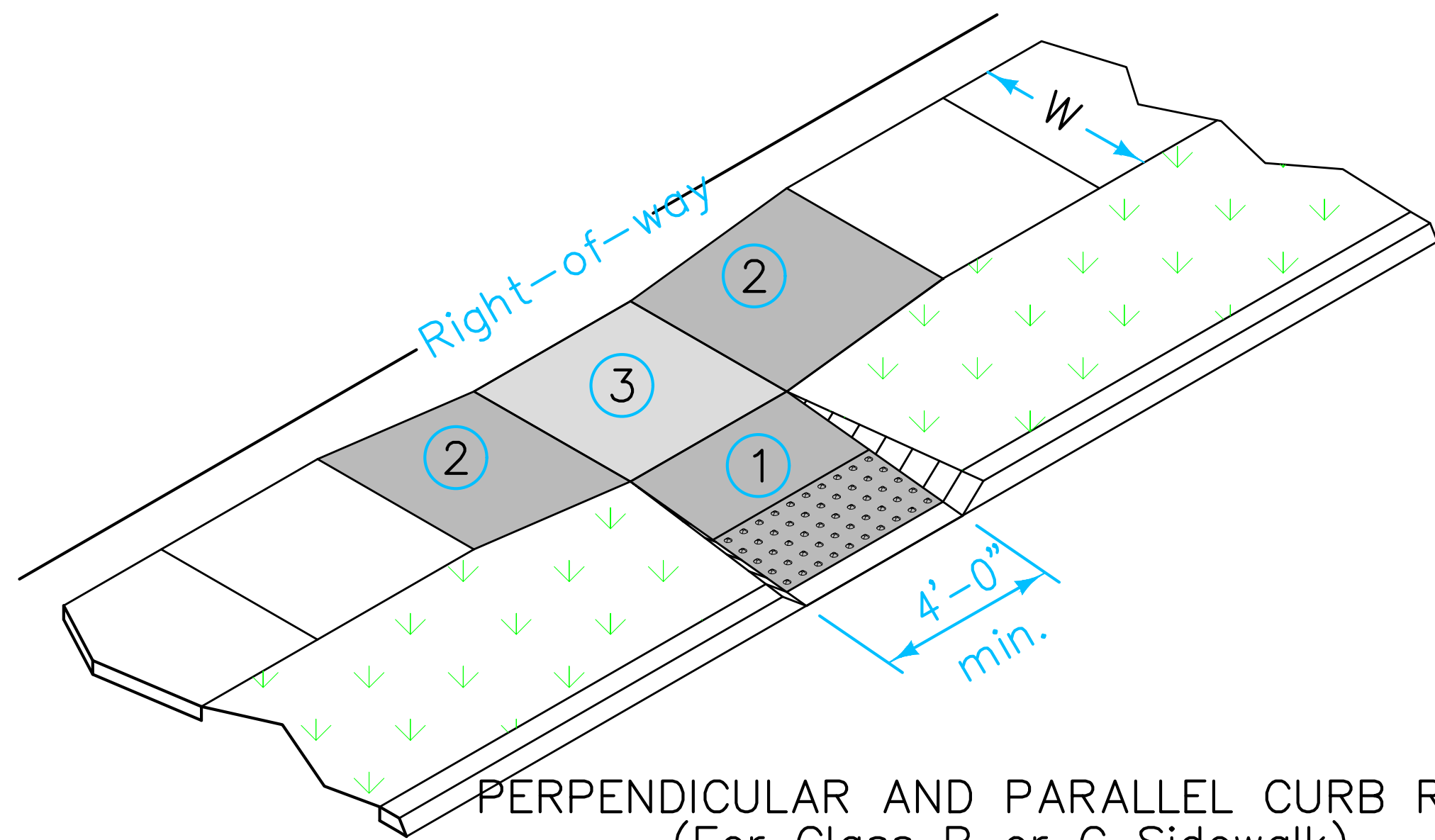

PERPENDICULAR AND PARALLEL CURB RAMP  
(For Class B or C Sidewalk)

Key

- Curb Ramp
- Turning Space
- Detectable Warning

- ① Perpendicular Curb Ramp: Target running slope of 6.25% with maximum running slope of 8.3%. Match pedestrian street crossing cross slope at back of curb. At mid-block crossings, cross slope may exceed 2.0% to match roadway grade.
- ② Parallel Curb Ramp: Target cross slope of 1.5% with a maximum cross slope of 2.0%. The length of the parallel ramp is not required to exceed 15 feet, regardless of resulting slope. Do not exceed 8.3% slope for parallel ramps shorter than 15 feet.
- ③ Turning Space: Target slope of 1.5%, with a maximum slope perpendicular to the travel directions of 2.0%. At mid-block crossings, cross slope of landing may exceed 2.0% to match roadway grade. Minimum 4 feet by 4 feet.
- ④ Flare (10:1 max.) required if ramp is contiguous with sidewalk.

	REVISION	
	New	10-16-12
	7030.206	
SHEET 1 of 1		
SUDAS Standard Specifications		
CURB RAMPS OUTSIDE OF INTERSECTION RADIUS		

FIGURE 7030.206 SHEET 1 OF 1

PROJECT: CEE-4850  
 DATE: 11/18/2024  
 DRAWN BY: Emma Oelmann  
 REVISION:  
 THE UNIVERSITY OF IOWA  
 CIVIL AND ENVIRONMENTAL ENGINEERING  
 4105 SEAMANS CENTER FOR THE ENGINEERING ARTS AND SCIENCES  
 IOWA CITY, IOWA 52242  
 PHONE: 319.335.5647  
 FAX: 319.335.5660  
 EMAIL: civil-hawks@iowa.edu



EDUCATIONAL - NOT FOR CONSTRUCTION

Agency St. Trail Project

122 Broadway St  
West Burlington, IA 52655

SHEET NAME  
SUDAS Curb Ramp Details

SHEET NO.  
**B-04**

White Acrylic Waterborne Paint  
Manual of Uniform Traffic Control  
Devices (MUTCD) Section 3D.18



PROJECT:	CEE: 4850
DATE :	11/18/2024
DRAWN BY:	Emma Oelmann
REVISION:	

**THE UNIVERSITY OF IOWA**  
**CIVIL AND ENVIRONMENTAL ENGINEERING**  
4105 SEAMANS CENTER FOR THE  
ENGINEERING ARTS AND SCIENCES  
103 S CAPITOL ST  
IOWA CITY, IOWA 52242  
PHONE: 319.335.5647  
FAX: 319.335.5660  
EMAIL: [civil-hawks@iowa.edu](mailto:civil-hawks@iowa.edu)



EDUCATIONAL - NOT  
FOR CONSTRUCTION

**Agency St. Trail Project**  
122 Broadway St.  
West Burlington, IA 52655

SHEET NAME  
Typical Driveway  
Crosswalk

SHEET NO.  
**B-05**



PROJECT: CEE: 4850  
 DATE: 11/18/2024  
 DRAWN BY: Emma Oelmann  
 REVISION:

**THE UNIVERSITY OF IOWA**  
**CIVIL AND ENVIRONMENTAL ENGINEERING**  
 4105 SEAMANS CENTER FOR THE  
 ENGINEERING ARTS AND SCIENCES  
 103 S CAPITOL ST  
 IOWA CITY, IOWA 52242  
 PHONE: 319.335.5647  
 FAX: 319.335.5660  
 EMAIL: civil-hawks@iowa.edu



EDUCATIONAL - NOT FOR CONSTRUCTION

**Agency St. Trail Project**  
 122 Broadway St.  
 West Burlington, IA 52655

SHEET NAME  
 6' x 2' Typical Crosswalk & Detectors

SHEET NO.  
**B-06**



# Gear Ave. to W Walmart Driveway

Start of Corridor

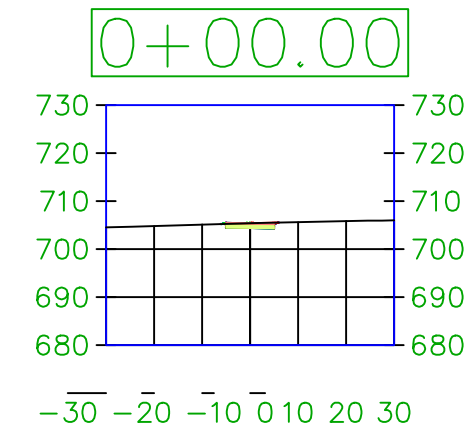

Drainage Ditch North

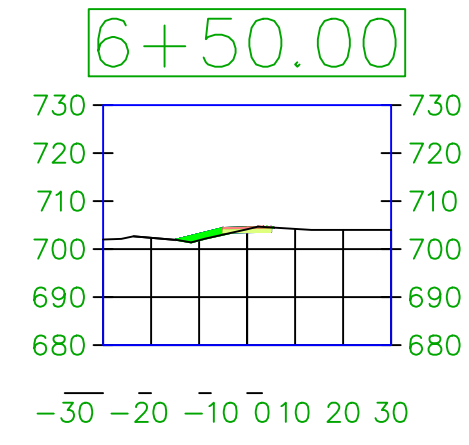

Drainage Ditch North

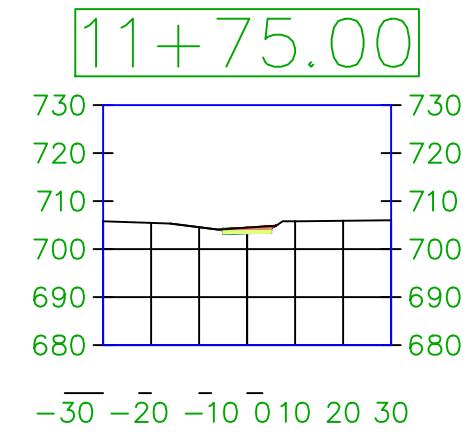

Drainage Ditch North

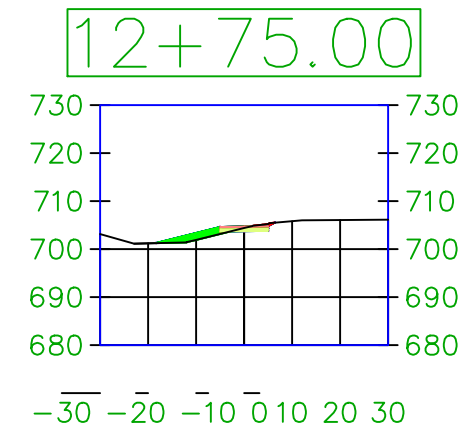

Drainage Ditch North

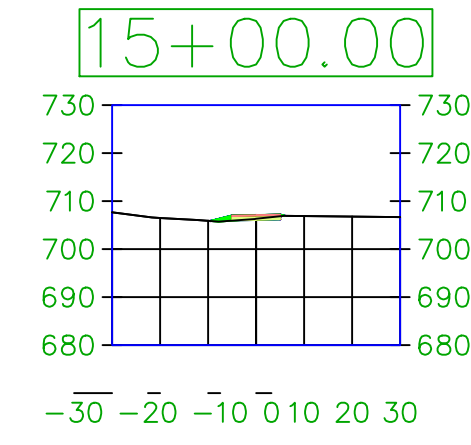

Near Intersection

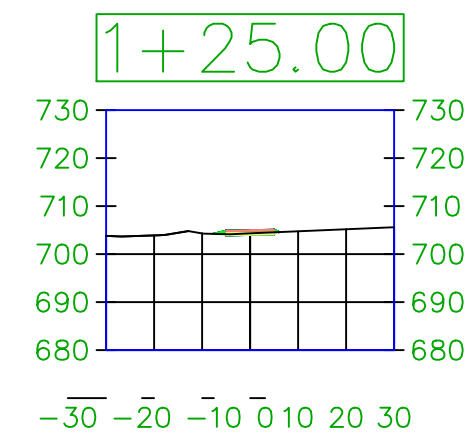

Drainage Ditch North

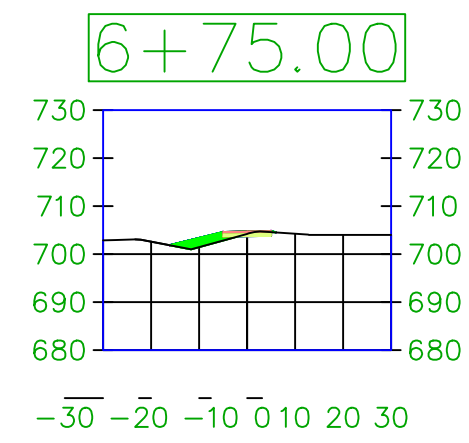

Drainage Ditch North

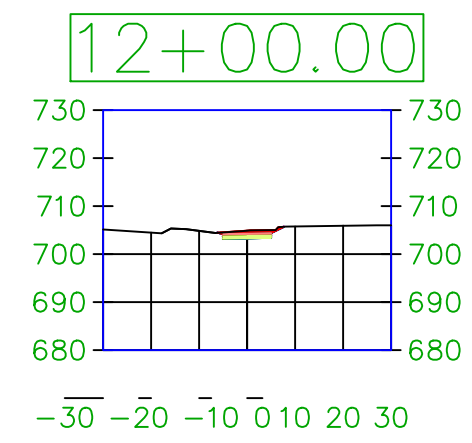

Drainage Ditch North

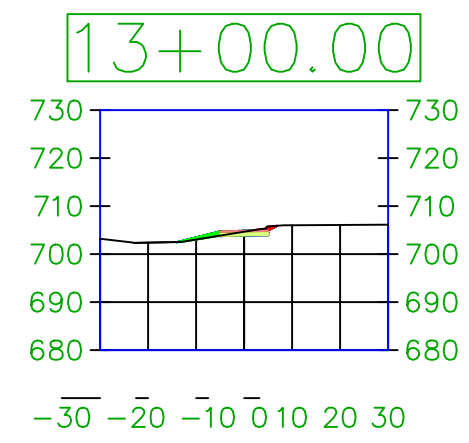

Drainage Ditch North

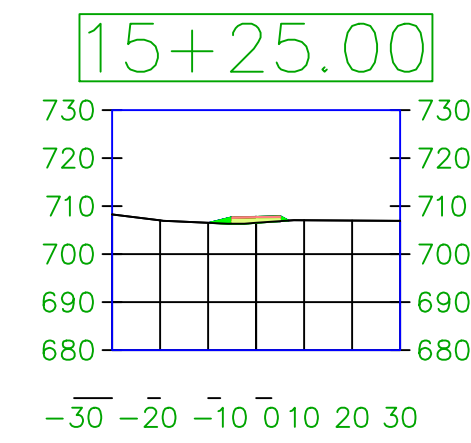

Drainage Ditch North

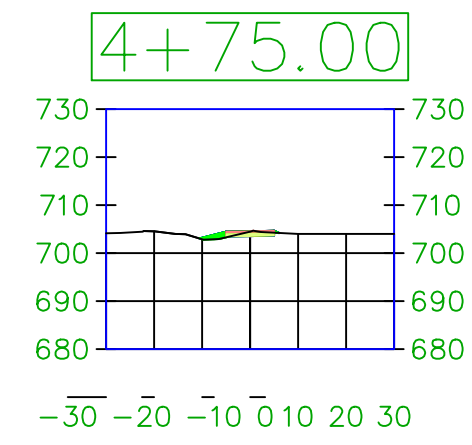

Near Driveway

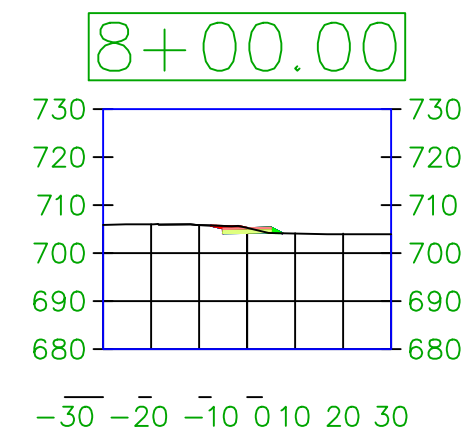

Drainage Ditch North

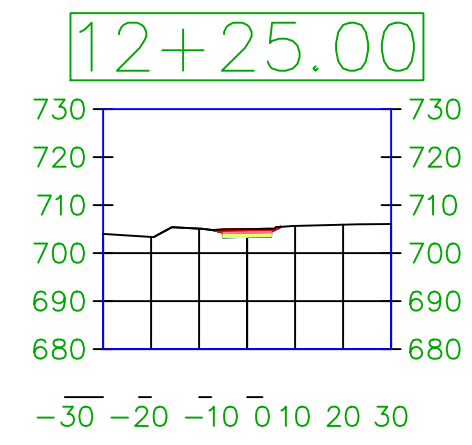

Drainage Ditch North

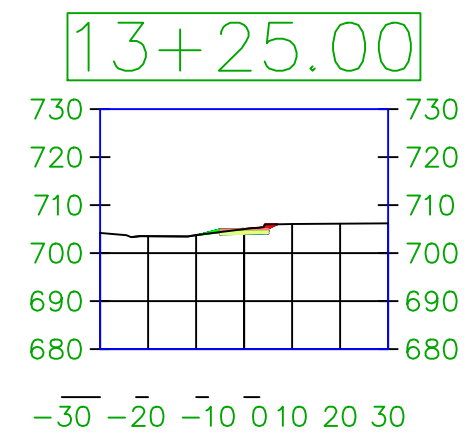

Near Driveway

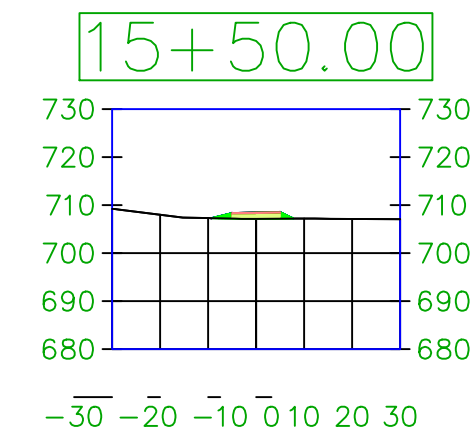

Drainage Ditch North

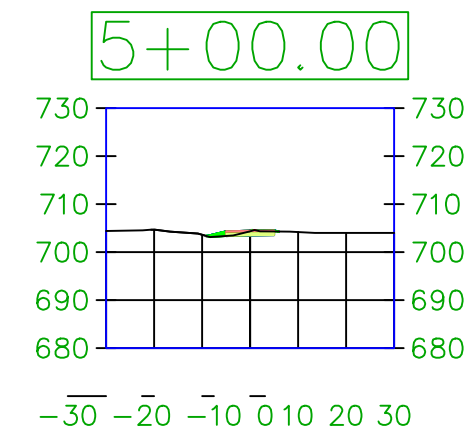

Drainage Ditch North

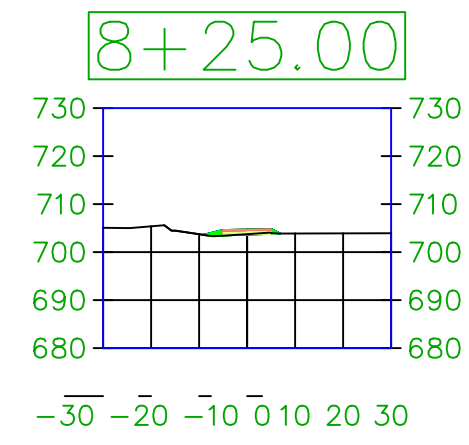

Drainage Ditch North

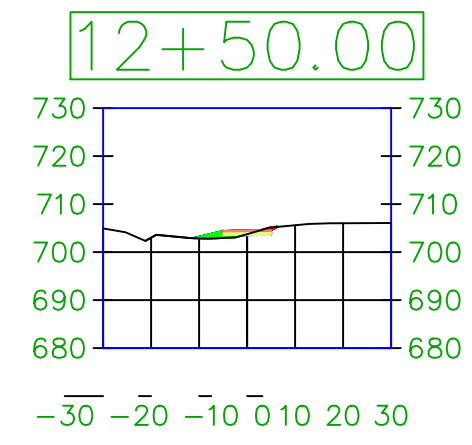

Drainage Ditch North

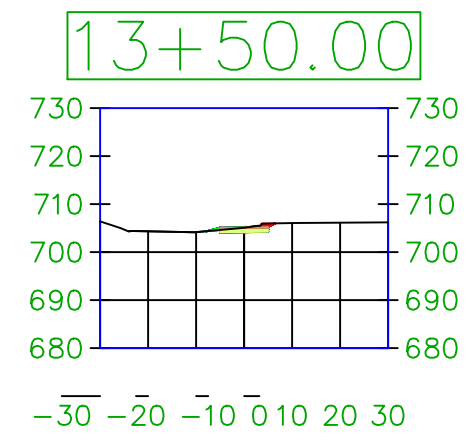

Drainage Ditch North

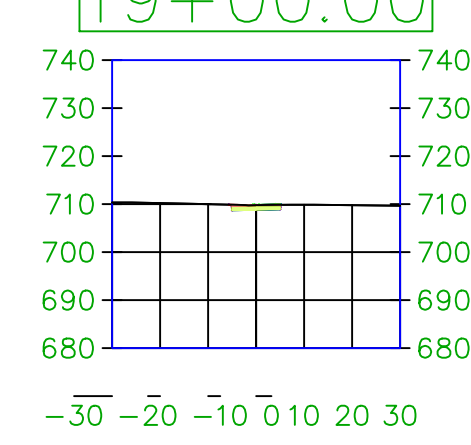

PROJECT: CEE: 4850

DATE: 11/18/2024

DRAWN BY: Blake Misfeldt

REVISION:

THE UNIVERSITY OF IOWA

CIVIL AND ENVIRONMENTAL ENGINEERING

4105 SEAMANS CENTER FOR THE ENGINEERING ARTS AND SCIENCES

103 S CAPITOL ST IOWA CITY, IOWA 52242

PHONE: 319.335.5647

FAX: 319.335.5660

EMAIL: civil-hawks@iowa.edu



EDUCATIONAL - NOT FOR CONSTRUCTION

Agency St. Trail Project

122 Broadway St. West Burlington, IA 52655

SHEET NAME

Gear Ave. to W Walmart Driveway

SHEET NO.

**B-07**

Drainage Ditch North

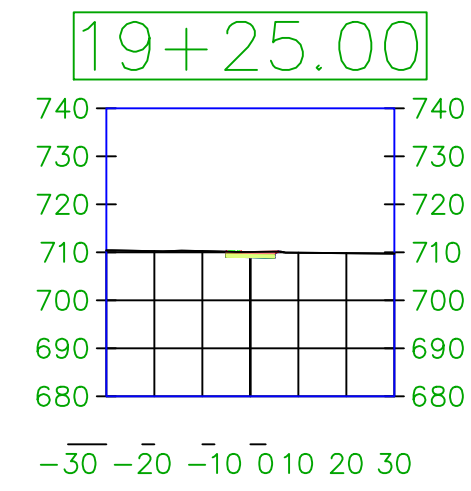

Drainage Ditch North

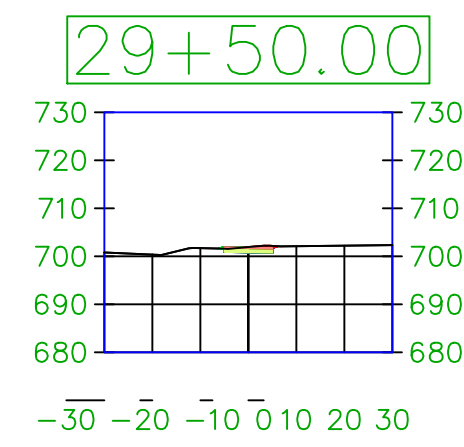

Drainage Ditch North

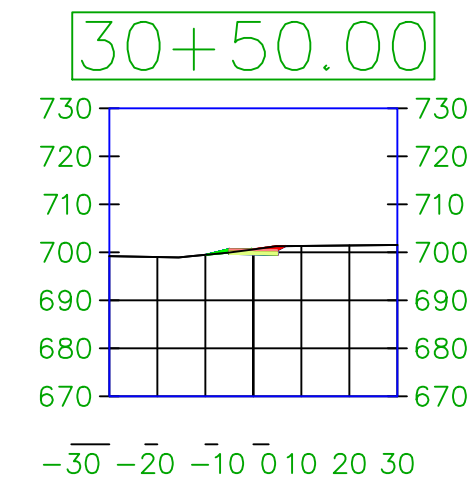

Drainage Ditch North

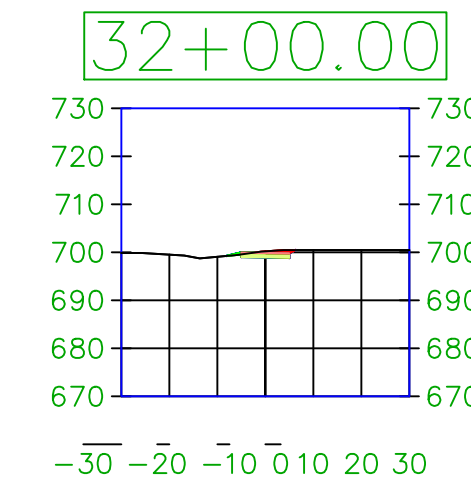

Drainage Ditch North

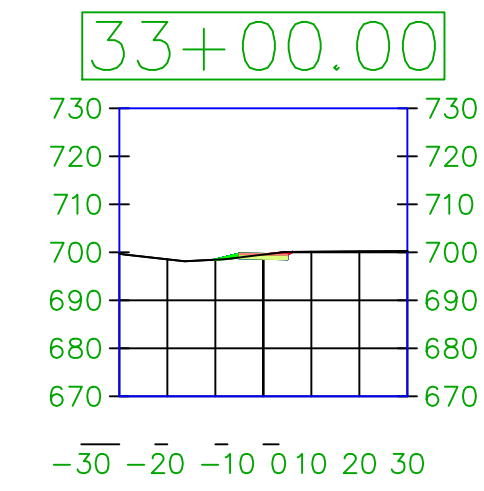

Near Driveway

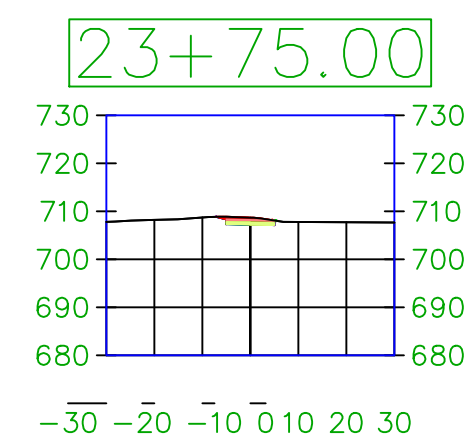

Drainage Ditch North

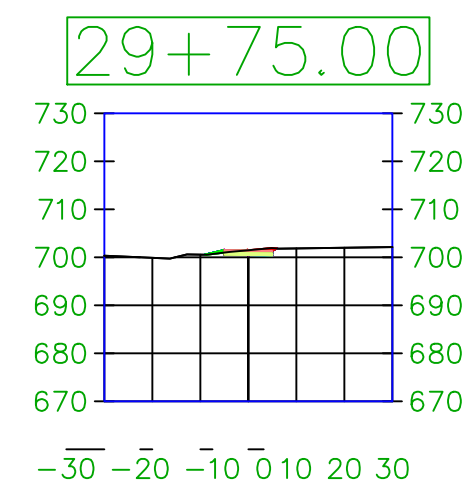

Drainage Ditch North

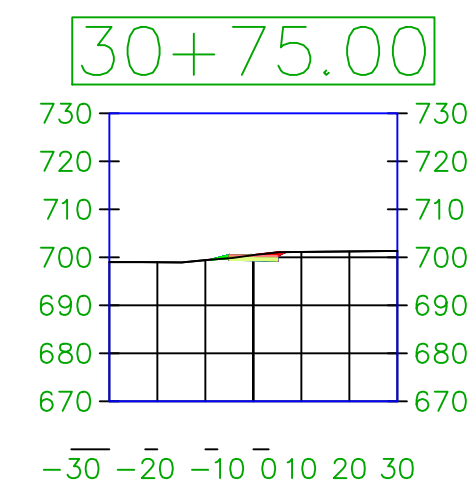

Drainage Ditch North

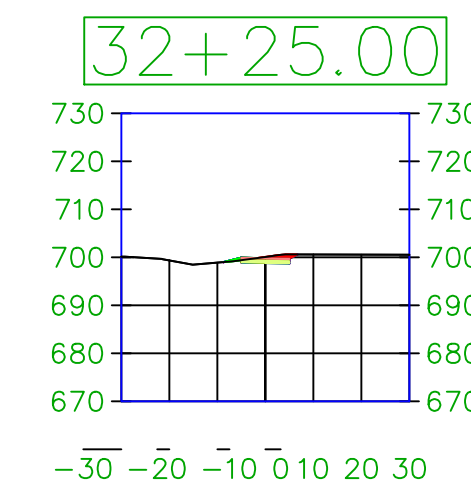

Drainage Ditch North

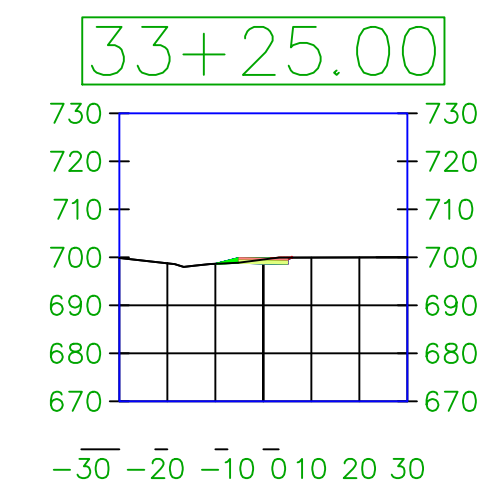

Near Driveway

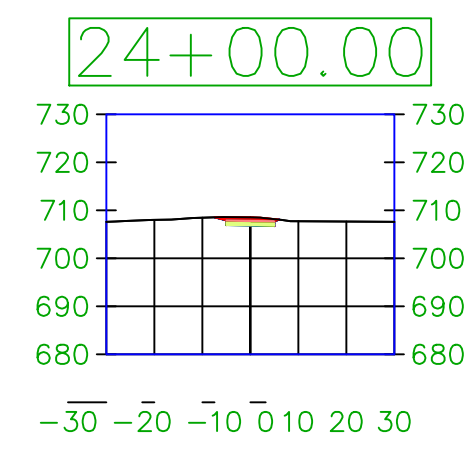

Drainage Ditch North

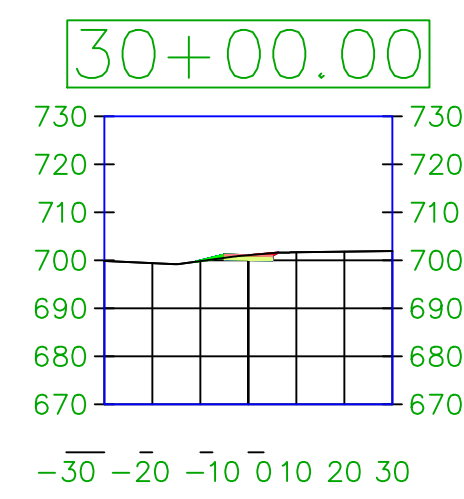

Drainage Ditch North

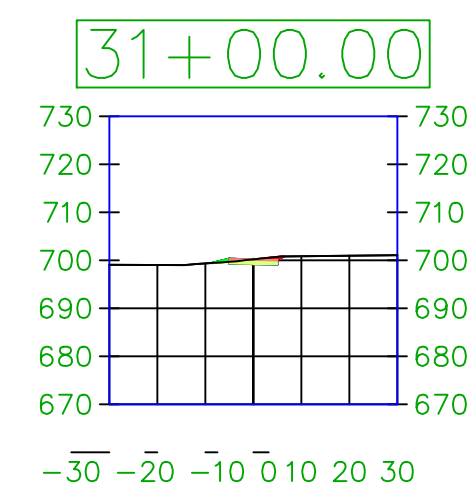

Drainage Ditch North

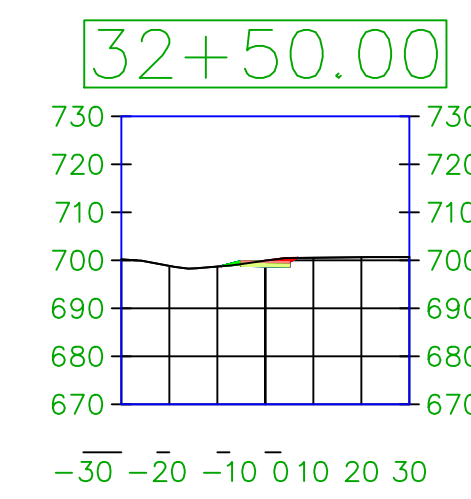

Drainage Ditch North

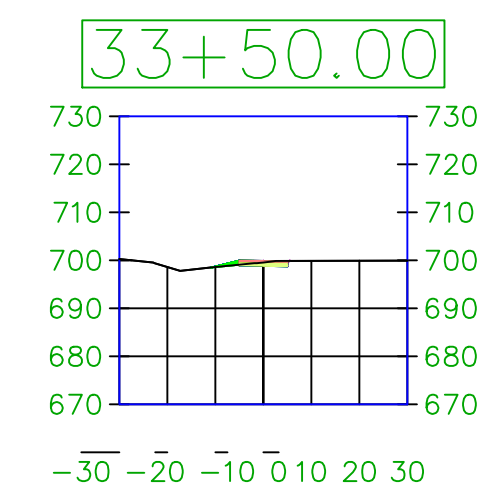

Near Driveway

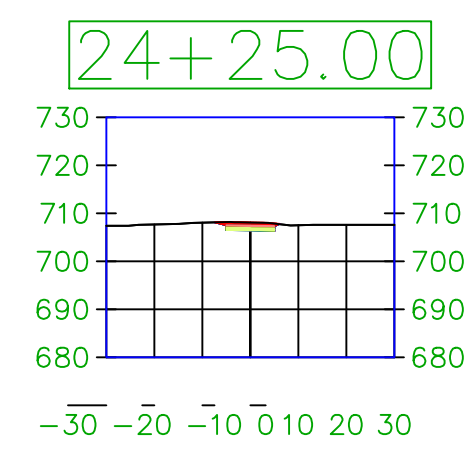

Drainage Ditch North

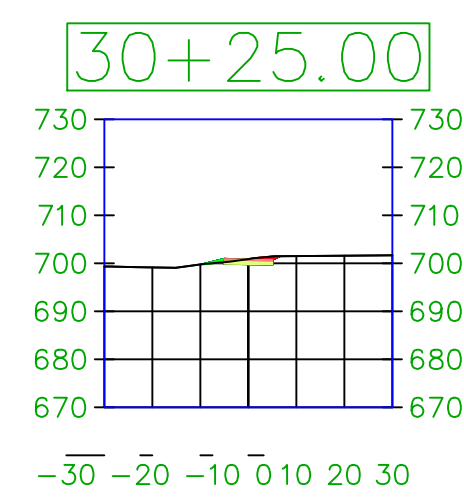

Drainage Ditch North

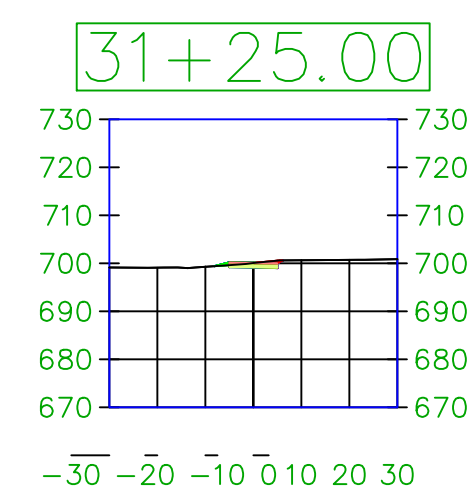

Drainage Ditch North

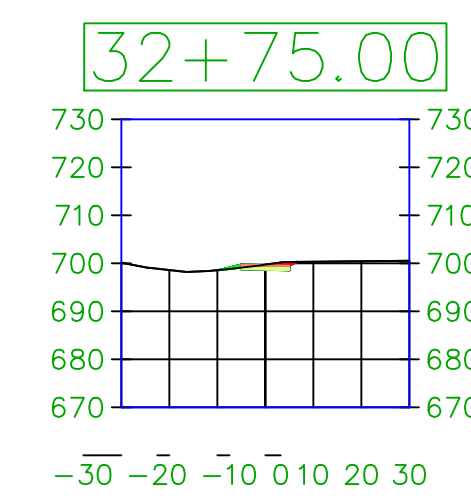

End of Corridor

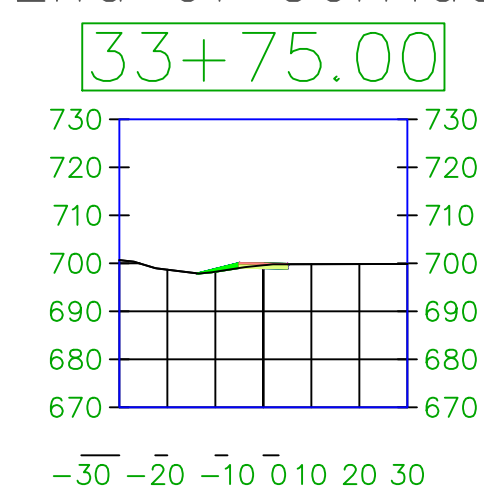

PROJECT: CEE: 4850

DATE: 11/18/2024

DRAWN BY: Blake Misfeldt

REVISION:

THE UNIVERSITY OF IOWA

CIVIL AND ENVIRONMENTAL ENGINEERING

4105 SEAMANS CENTER FOR THE ENGINEERING ARTS AND SCIENCES

103 S CAPITOL ST IOWA CITY, IOWA 52242

PHONE: 319.335.5647

FAX: 319.335.5660

EMAIL: civil-hawks@iowa.edu



EDUCATIONAL - NOT FOR CONSTRUCTION

Agency St. Trail Project

122 Broadway St. West Burlington, IA 52655

SHEET NAME

Gear Ave. to W Walmart Driveway

SHEET NO.

B-08

Gas Station Trail

Walmart Trail

W Walmart Driveway  
to Broadway St.

Broadway St. Trail  
North of Agency St.

Start of Corridor

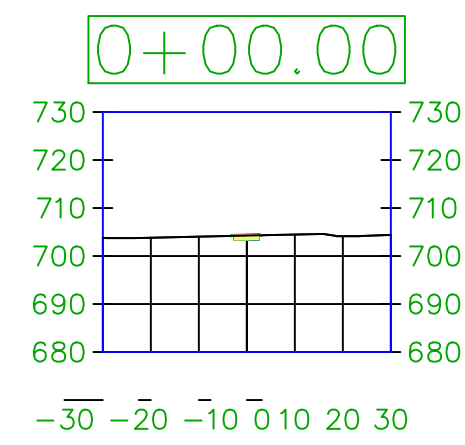

Start of Corridor

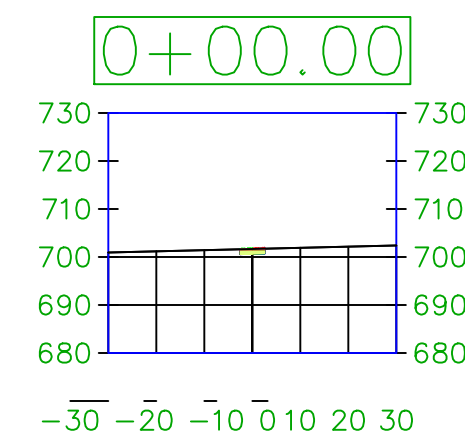

Start of Corridor

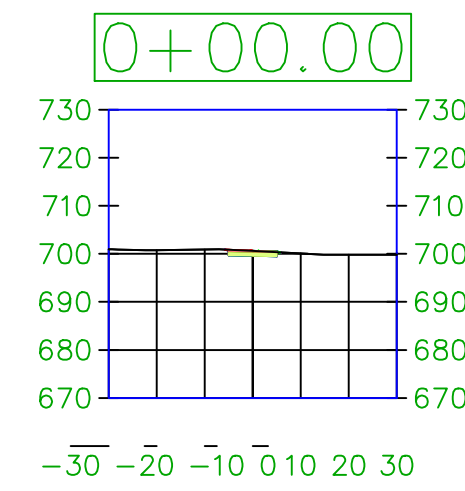

Start of Corridor

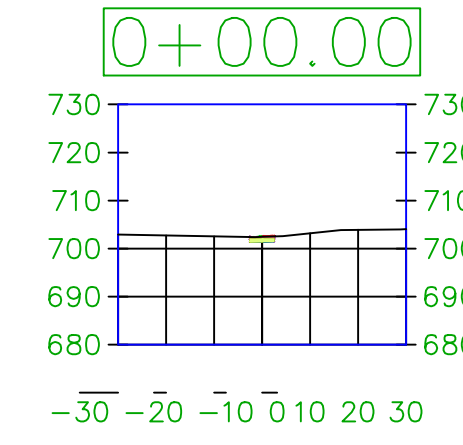

End of Corridor

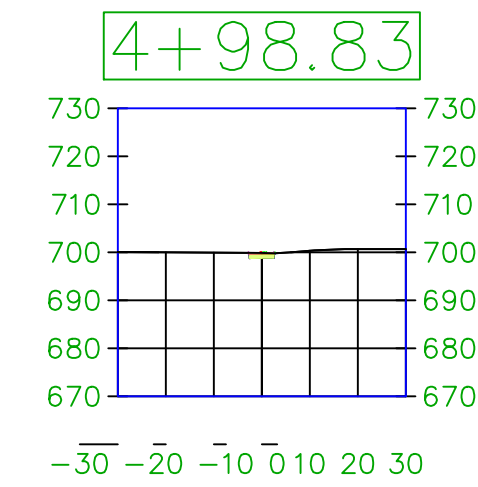

End of Corridor

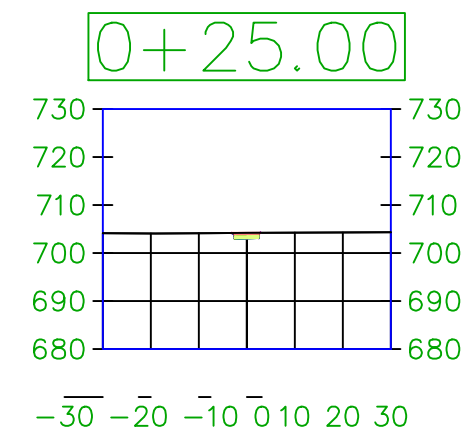

End of Corridor

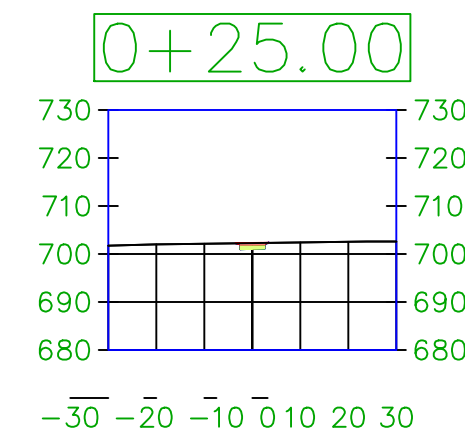

End of Corridor

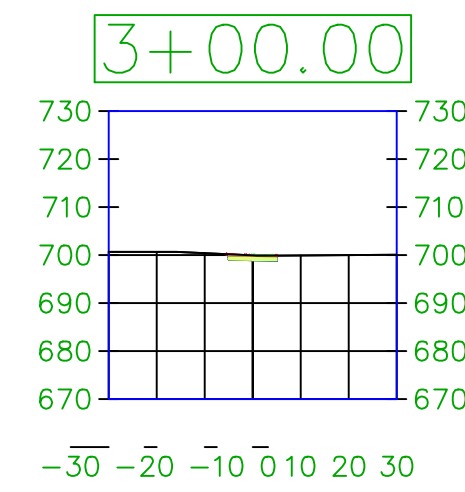

Near Intersection

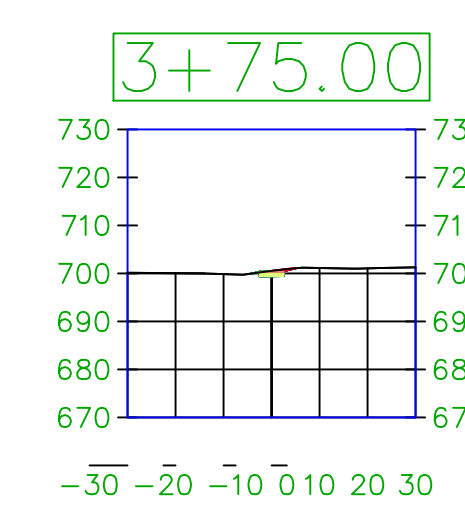

Near Intersection

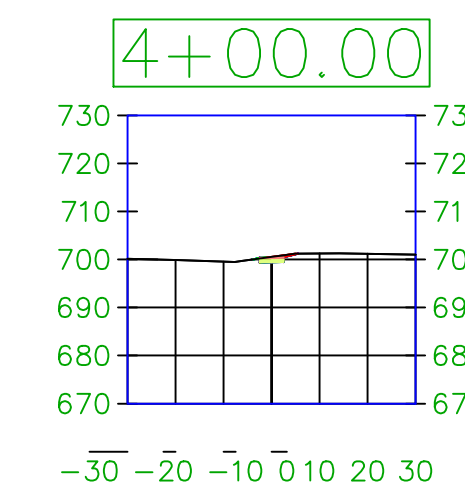

Near Intersection

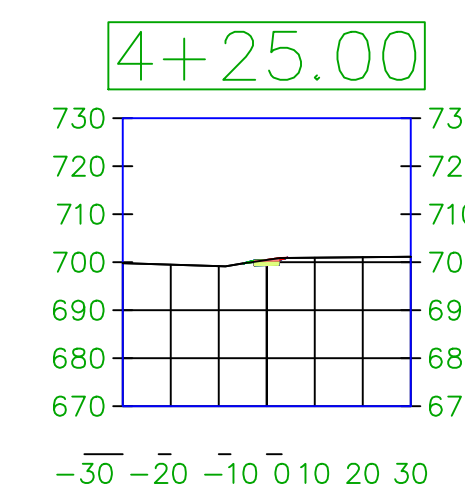

PROJECT: CEE: 4850

DATE: 11/18/2024

DRAWN BY: Blake Misfeldt

REVISION:

THE UNIVERSITY OF IOWA

CIVIL AND ENVIRONMENTAL ENGINEERING

4105 SEAMANS CENTER FOR THE ENGINEERING ARTS AND SCIENCES

103 S CAPITOL ST IOWA CITY, IOWA 52242

PHONE: 319.335.5647

FAX: 319.335.5660

EMAIL: civil-hawks@iowa.edu



EDUCATIONAL - NOT FOR CONSTRUCTION

Agency St. Trail Project

122 Broadway St.  
West Burlington, IA 52655

SHEET NAME

Various Cross Sections

SHEET NO.

**B-09**

# Broadway St. to West Burlington Ave.

Start of Corridor

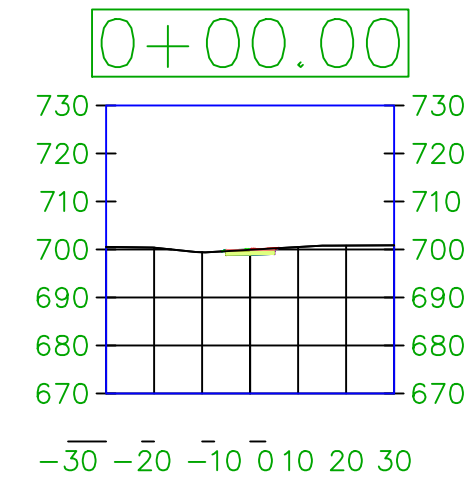

Drainage Ditch North

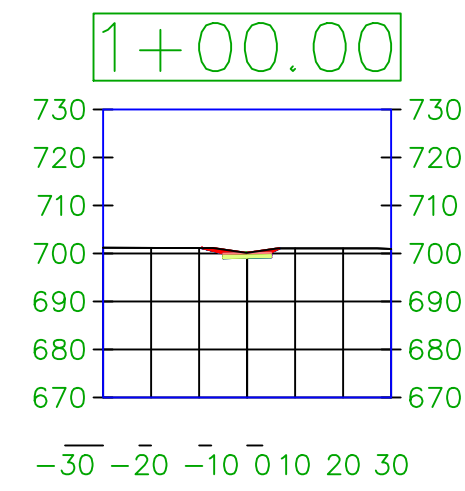

Near Driveway

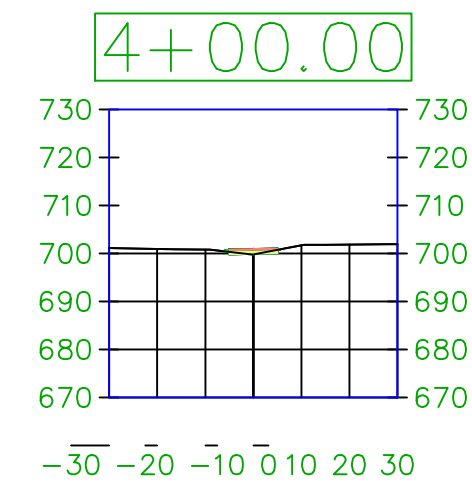

Drainage Ditch North

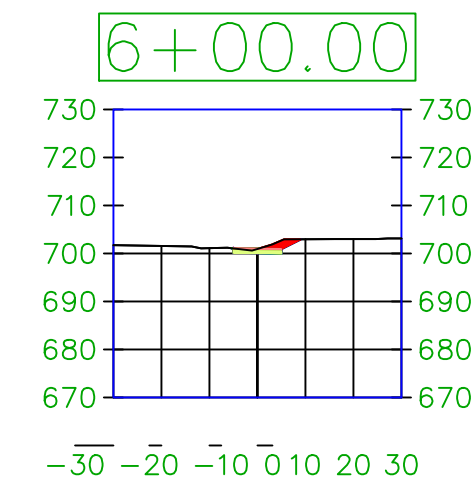

End of Corridor

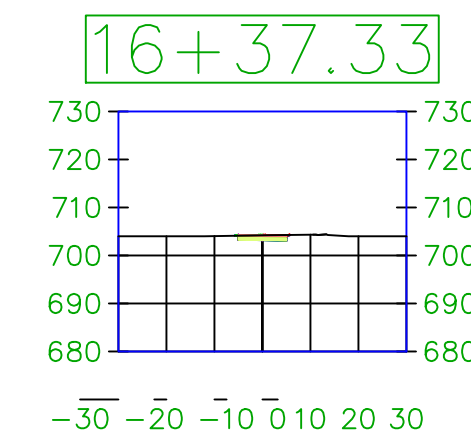

Drainage Ditch North

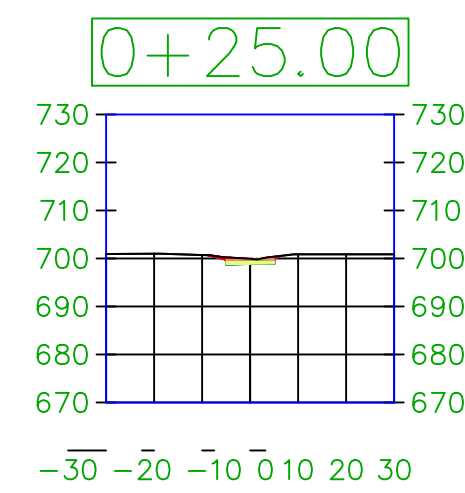

Drainage Ditch North

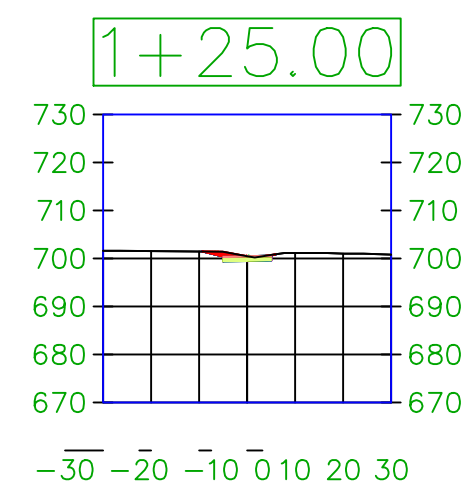

Near Driveway

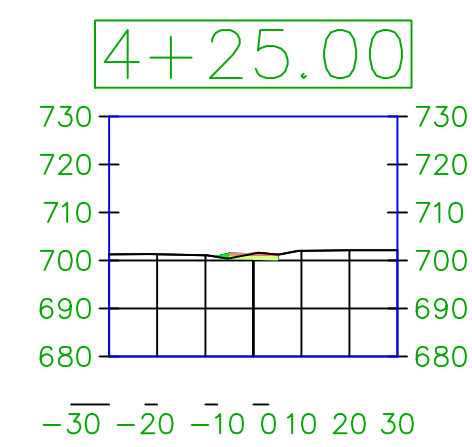

Cut Needed Near Road

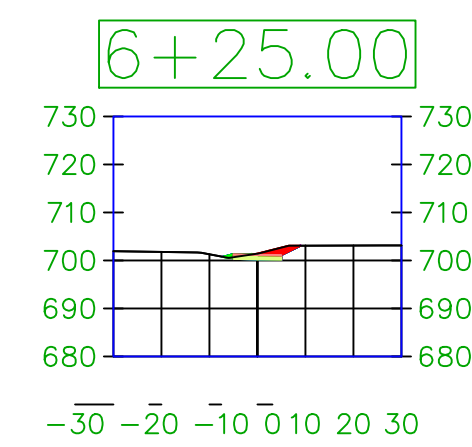

Drainage Ditch North

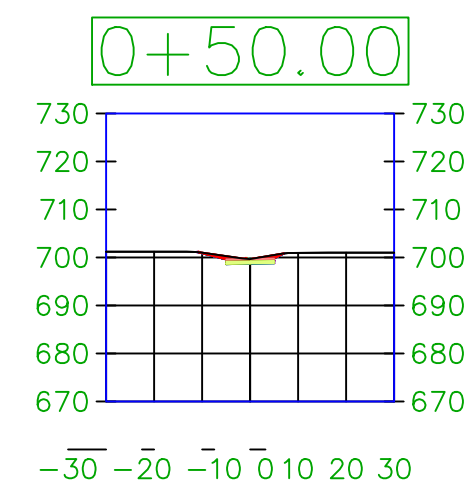

Drainage Ditch North

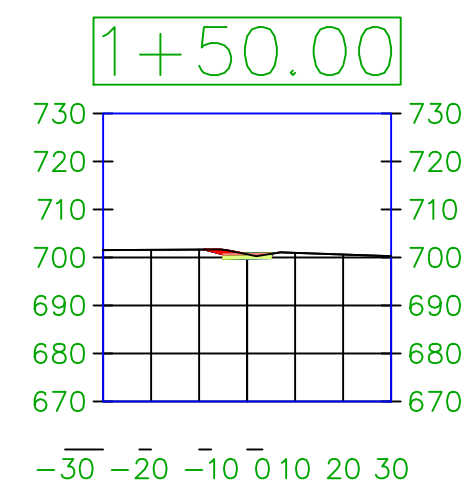

Near Driveway

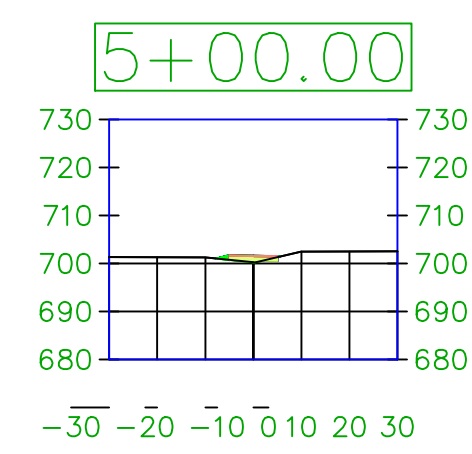

Cut Needed Near Road

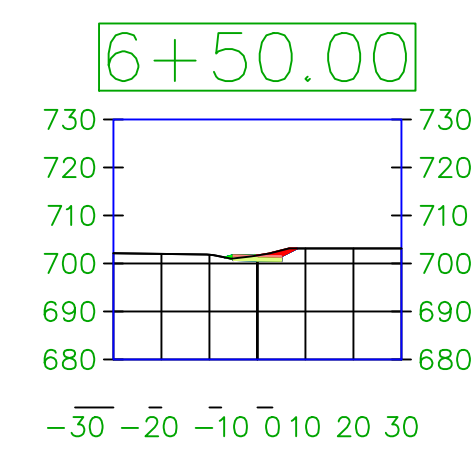

Drainage Ditch North

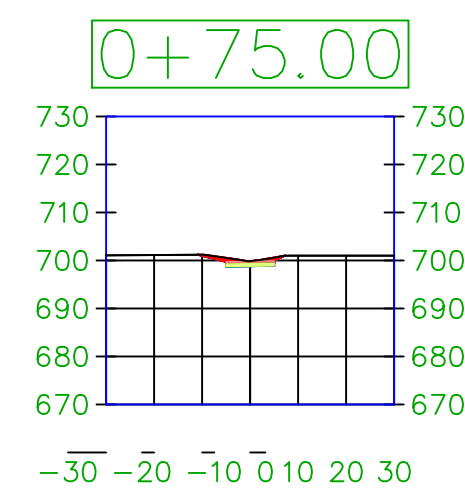

Drainage Ditch North

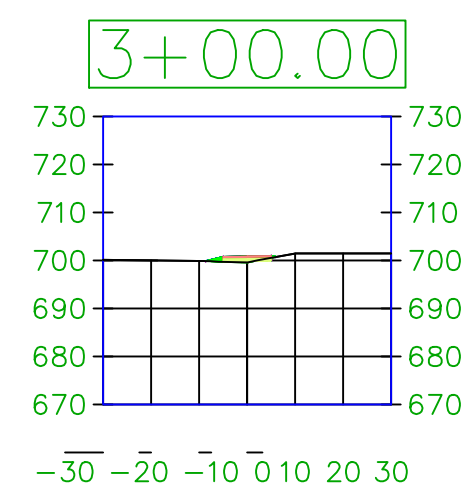

Near Driveway

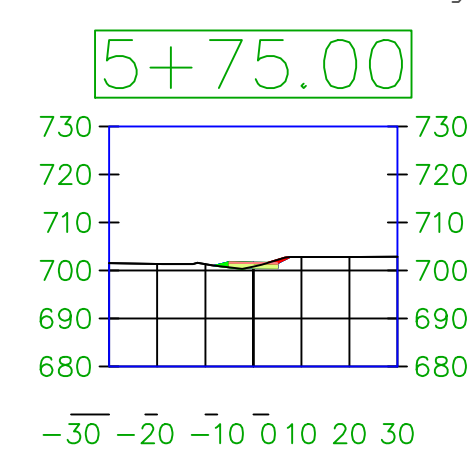

Cut Needed Near Road

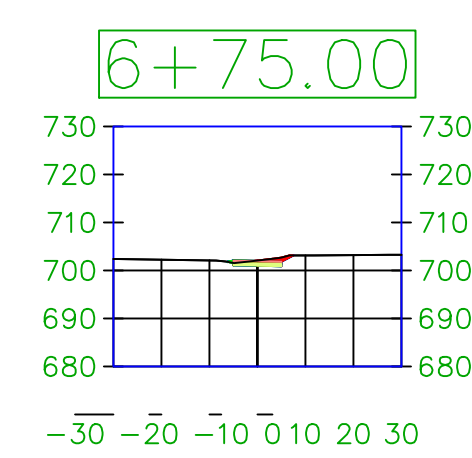

PROJECT: CEE: 4850  
 DATE: 11/18/2024  
 DRAWN BY: Blake Misfeldt  
 REVISION:

**THE UNIVERSITY OF IOWA**  
**CIVIL AND ENVIRONMENTAL ENGINEERING**  
 4105 SEAMANS CENTER FOR THE  
 ENGINEERING ARTS AND SCIENCES  
 103 S CAPITOL ST  
 IOWA CITY, IOWA 52242  
 PHONE: 319.335.5647  
 FAX: 319.335.5660  
 EMAIL: civil-hawks@iowa.edu



EDUCATIONAL - NOT FOR CONSTRUCTION

**Agency St. Trail Project**  
 122 Broadway St,  
 West Burlington, IA 52655

SHEET NAME  
 Broadway St. to W Burlington Ave.

SHEET NO.  
**B-10**

# Agency St. to Rec Plex

Start of Corridor

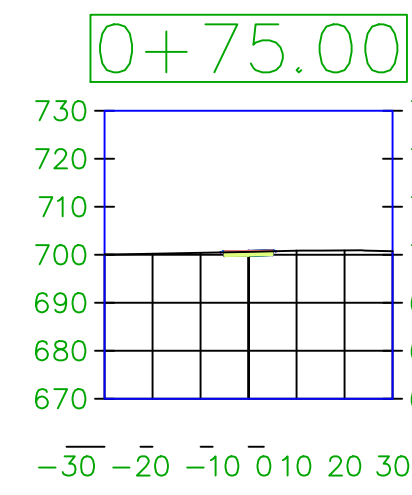

Drainage Ditch Near Intersection

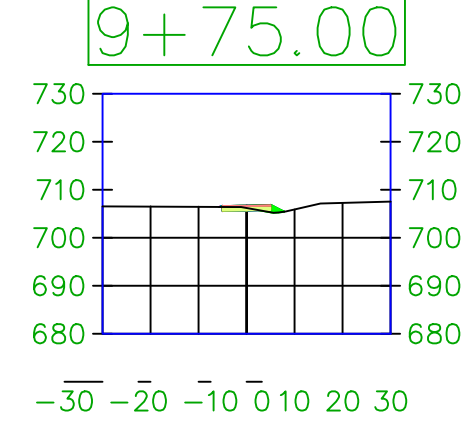

Drainage Ditch East

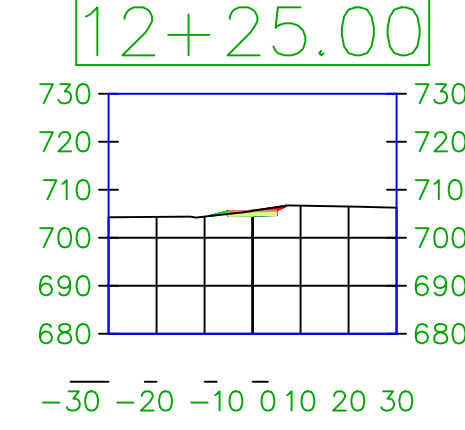

Drainage Ditch Near Driveway

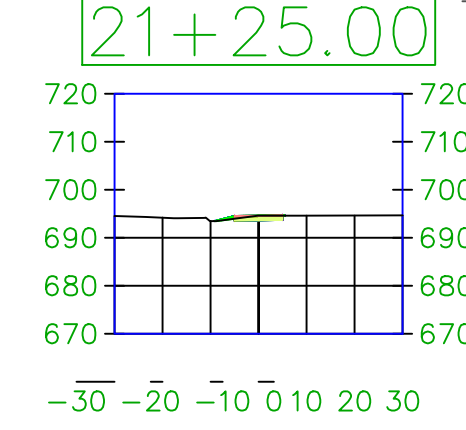

Near Intersection

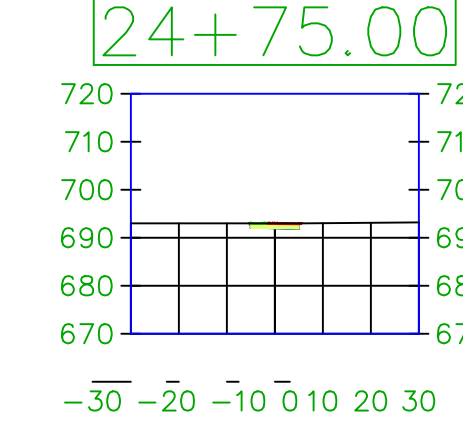

Drainage Ditch Near Intersection

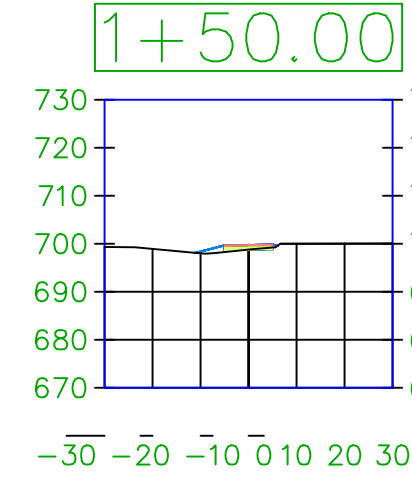

Drainage Ditch East

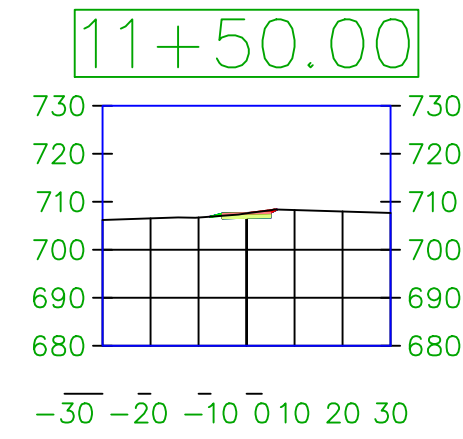

Drainage Ditch East

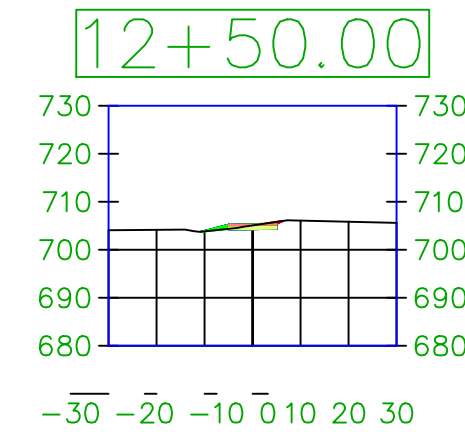

Drainage Ditch East

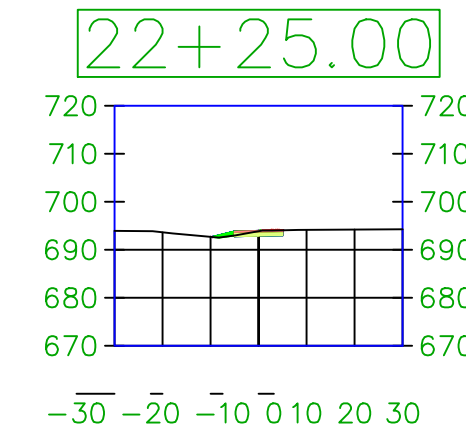

Near Intersection

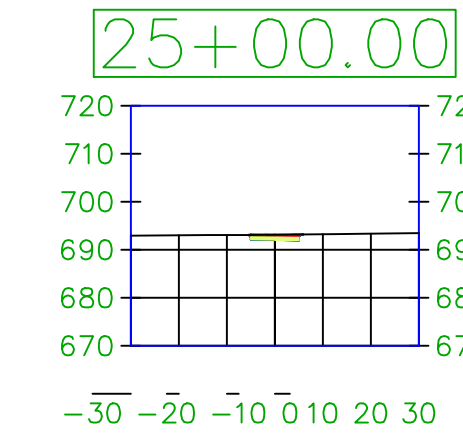

Cut Needed Between Road and Parking Lot

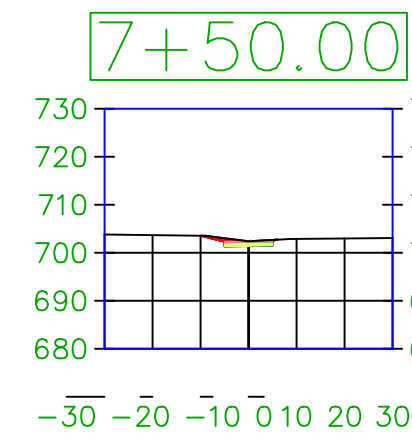

Drainage Ditch East

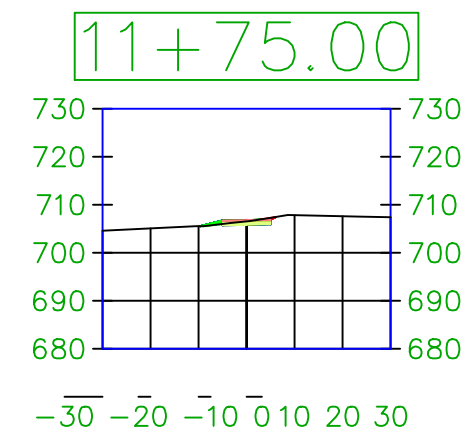

Drainage Ditch East

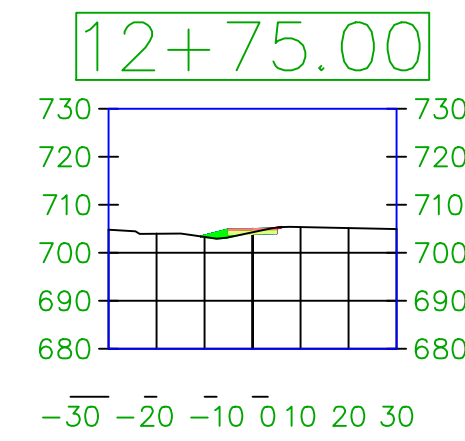

Drainage Ditch East

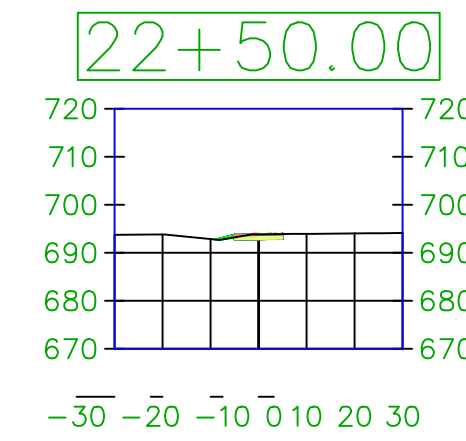

End of Corridor

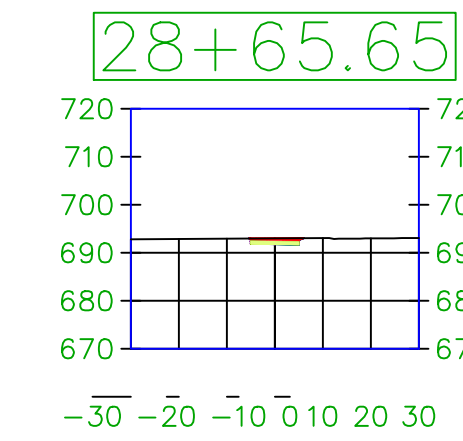

Cut Needed Between Road and Parking Lot

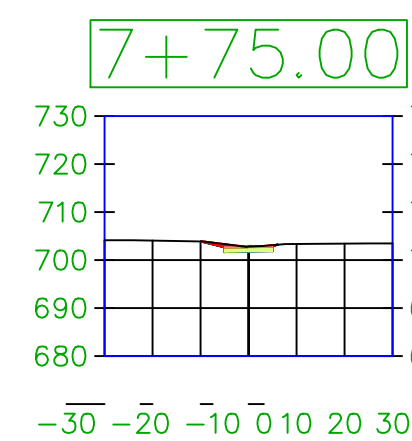

Drainage Ditch East

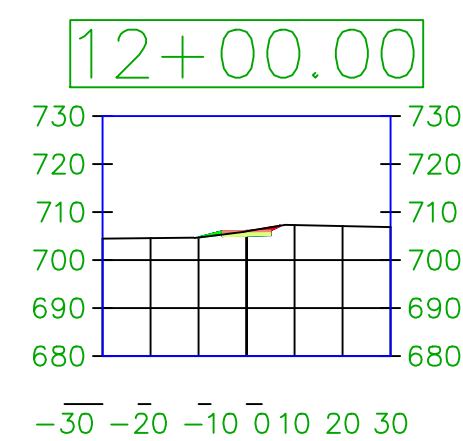

Drainage Ditch East

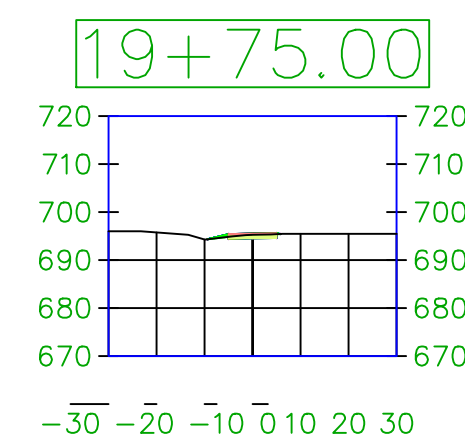

Near Intersection

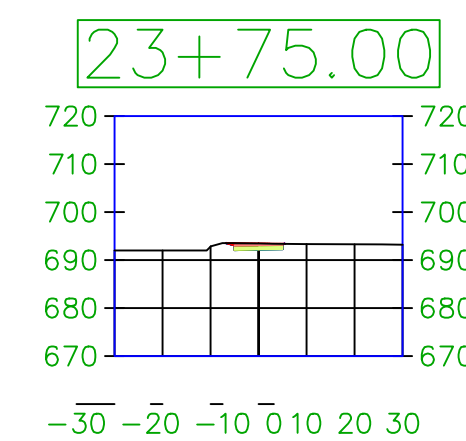

PROJECT: CEE: 4850  
 DATE: 11/18/2024  
 DRAWN BY: Blake Misfeldt  
 REVISION:

**THE UNIVERSITY OF IOWA**  
**CIVIL AND ENVIRONMENTAL ENGINEERING**  
 4105 SEAMANS CENTER FOR THE  
 ENGINEERING ARTS AND SCIENCES  
 103 S CAPITOL ST  
 IOWA CITY, IOWA 52242  
 PHONE: 319.335.5647  
 FAX: 319.335.5660  
 EMAIL: civil-hawks@iowa.edu



EDUCATIONAL - NOT FOR CONSTRUCTION

## Agency St. Trail Project

122 Broadway St.  
 West Burlington, IA 52655

SHEET NAME  
 Agency St. to Rec Plex

SHEET NO.  
**B-11**

Rec Plex Trail  
Heading South

Mall Intersection Trail

Start of Corridor

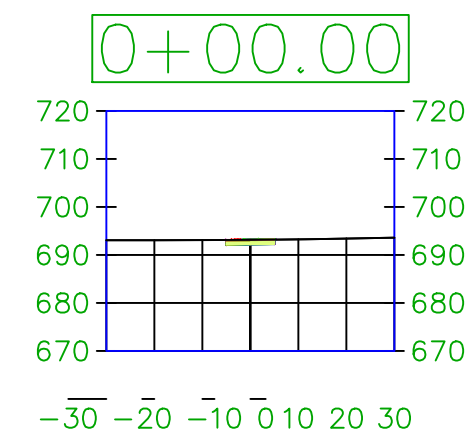

Start of Corridor

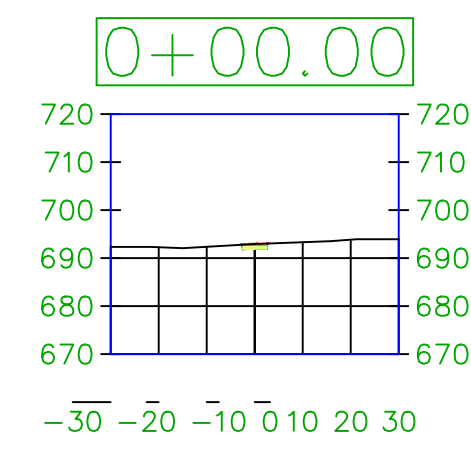

End of Corridor

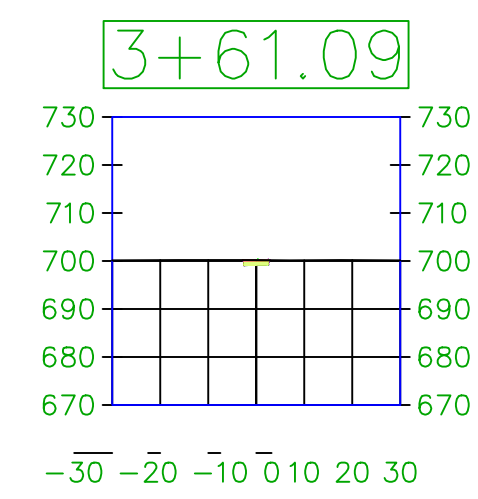

Cut Needed Near  
Rec Plex Sign

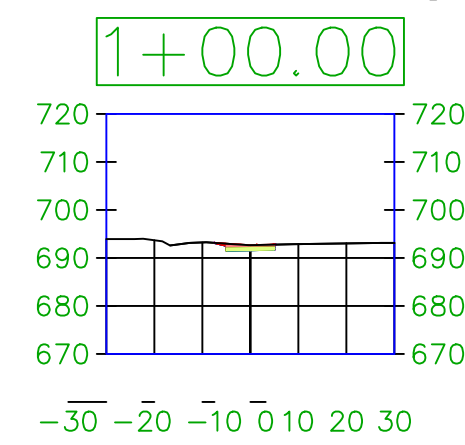

Cut Needed Between  
Road and Parking Lot

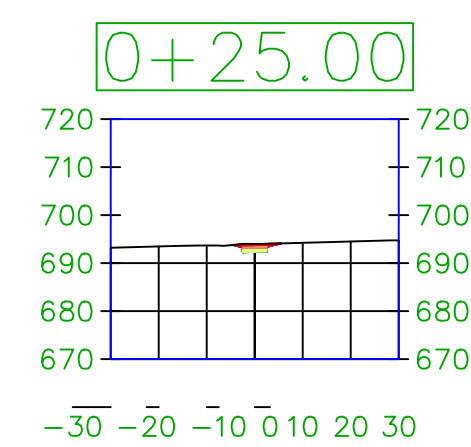

End of Corridor

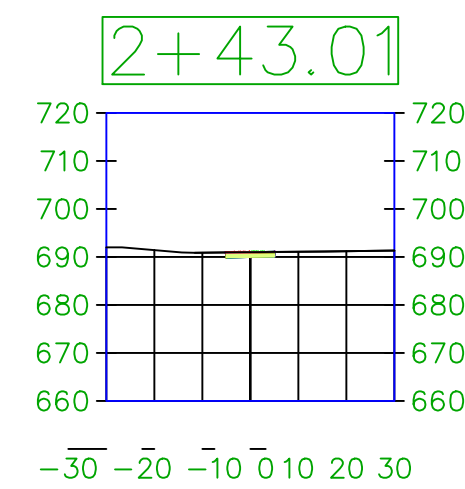

Cut Needed Between  
Road and Parking Lot

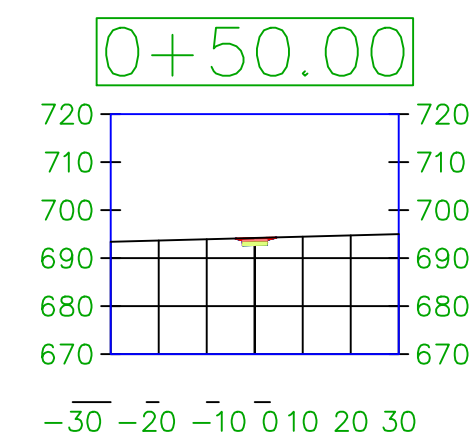

Drainage Ditch West

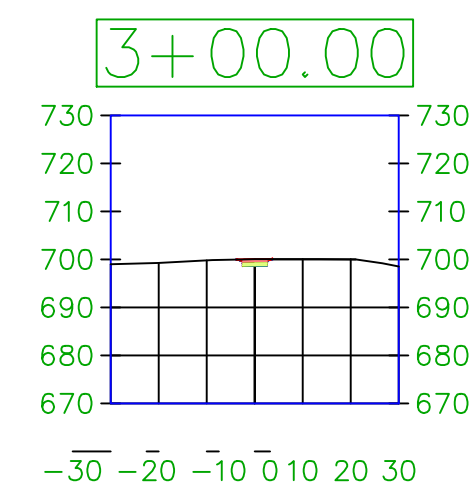

PROJECT: CEE: 4850

DATE: 11/18/2024

DRAWN BY: Blake Misfeldt

REVISION:

THE UNIVERSITY OF IOWA

CIVIL AND ENVIRONMENTAL ENGINEERING

4105 SEAMANS CENTER FOR THE  
ENGINEERING ARTS AND SCIENCES

103 S CAPITOL ST  
IOWA CITY, IOWA 52242

PHONE: 319.335.5647

FAX: 319.335.5660

EMAIL: civil-hawks@iowa.edu



EDUCATIONAL - NOT  
FOR CONSTRUCTION

Agency St. Trail Project

122 Broadway St.  
West Burlington, IA 52655

SHEET NAME

Rec Plex Trail  
& Mall Intersection

SHEET NO.

**B-12**

Right-of-Way Purchase Needed			
Alignment	Leave ROW (STA)	Returns to ROW (STA)	Length of ROW Needed (LF)
Gear Ave. to W Walmart Driveway	6+37	34+00	2763
W Walmart Driveway to Broadway St.	0+00	2+25	225
Broadway St. to W Burlington Ave.	0+13	5+50	537
Broadway St. to W Burlington Ave.	7+41	12+22	481
Broadway St. to W Burlington Ave.	12+75	15+69	294
Broadway St. North of Agency St.	0+00	4+94	494
Broadway St. South to Rec Plex	0+95	1+48	53
Broadway St. South to Rec Plex	9+63	10+16	53
Broadway St. South to Rec Plex	24+74	24+93	19
Broadway St. South to Rec Plex	27+50	28+66	116
Extra Trail by Rec Plex Heading South	0+10	2+43	233
Mall Intersection Trail	0+00	3+61	361
		Agency St. Trail	4794
		Broadway St. Trail	474
		Mall Intersection Trail	361
		Total Project	5629

Intersection & Crosswalk Material Quantities			
	Agency St. Trail	Broadway St. Trail	Mall Trail
Number of 10' x 2' Markings (Unit)	115	82	0
Number of 6' x 2' Markings (Unit)	26	0	14
Total Stop Bars (LF with 2' Width)	137	64	40
Pavement Markings (LF with 1' Width)	2886	1768	248
Pavement Markings Removed (LF)	362	92	84
Number of Stand-Alone Pedestrian Push Buttons (Unit)	6	1	0
Symbols Removed (Unit)	4	3	0
Symbols Added (Unit)	4	3	0

Trail Material Quantities			
	Agency St. Trail	Broadway St. Trail	Mall Trail
Cut (CY)	216.1	83.2	11.5
Fill (CY)	418.5	138.8	6.3
PCC (CY)	892.3	531.6	33.4
Base (CY)	892.3	531.6	33.4
6" PCC (SF)	48186.4	28705.9	1805.2
6" Granular Base (SF)	48186.4	28705.9	1805.2
10' Wide Trail (LF)	4793.7	2646.2	0.0
5' Wide Trail (LF)	49.9	448.9	361.0
Corridor Surface Area (SF)	61185.9	31646.6	2537.0
Corridor Surface Area (Acres)	1.41	0.73	0.06

PROJECT: CEE: 4850  
DATE: 11/18/2024  
DRAWN BY: Blake Misfeldt  
REVISION:

**THE UNIVERSITY OF IOWA**  
**CIVIL AND ENVIRONMENTAL ENGINEERING**  
4105 SEAMANS CENTER FOR THE  
ENGINEERING ARTS AND SCIENCES  
103 S CAPITOL ST  
IOWA CITY, IOWA 52242  
PHONE: 319.335.5647  
FAX: 319.335.5660  
EMAIL: civil-hawks@iowa.edu



EDUCATIONAL - NOT FOR CONSTRUCTION

**Agency St. Trail Project**  
122 Broadway St.  
West Burlington, IA 56255

SHEET NAME  
Quantity Tables

SHEET NO.  
**C-01**

Agency St. Trail Cost Estimation						
Reference	Item Code	Bid Item Description	Unit	Unit Price	Quantity	Cost
Iowa Public Works Bureau Bid Tabulation Report	2010-B	CLEARING AND GRUBBING	Acre	\$7102.73	1.405	\$9976.74
Iowa Public Works Bureau Bid Tabulation Report	1020-E	EXCAVATION, CLASS 10, CLASS 12, OR CLASS 13	CY	\$8.12	216.12	\$1754.89
RS Means Heavy Construction Costs	G1030 115 1000	CUT & FILL COMMON EARTH	CY	\$10.56	202.39	\$2137.24
Iowa Public Works Bureau Bid Tabulation Report	7030-C	SHARED USE PATH, PCC, 6"	SY	\$48.20	5354.04	\$258064.73
Iowa Public Works Bureau Bid Tabulation Report	1020-J	SUBBASE, GRANULAR, 6"	SY	\$10.75	5354.04	\$57555.93
Iowa Public Works Bureau Bid Tabulation Report	9010-A	CONVENTIONAL SEEDING, SEEDING, FERTILIZING, AND MULCHING. 1	Acre	\$2451.62	1.405	\$3443.63
Pilot Rock RJ Thomas Mfg. Co.	N/a	100% RECYCLED PLASTIC BENCH – WITH BACKREST. RBB SERIES	EA	\$1000.00	2	\$2000.00
RS Means Heavy Construction Costs	32 17 23.13 0604	ACRYLIC WATERBORNE, WHITE, 12" WIDE, LESS THAN 3,000-16,000 LF	LF	\$1.60	2886	\$4617.60
Iowa Public Works Bureau Bid Tabulation Report	8020-K	PAVEMENT MARKINGS REMOVED	STA	\$10.78	3.62	\$39.02
Iowa Public Works Bureau Bid Tabulation Report	8020-G	PAINTED SYMBOLS AND LEGENDS, WATERBORNE OR SOLVENT-BASED	EA	\$102.40	4	\$409.60
Iowa Public Works Bureau Bid Tabulation Report	8020-L	SYMBOLS AND LEGENDS REMOVED	EA	\$88.33	4	\$353.32
Traffic Safety Corp	N/a	BULLDOG III PUSH-BUTTON STATIONS	EA	\$3000.00	6	\$18000.00
					Total	\$358352.71

Broadway St. Trail Cost Estimation						
Reference	Item Code	Bid Item Description	Unit	Unit Price	Quantity	Cost
Iowa Public Works Bureau Bid Tabulation Report	2010-B	CLEARING AND GRUBBING	Acre	\$7102.73	0.727	\$5160.17
Iowa Public Works Bureau Bid Tabulation Report	1020-E	EXCAVATION, CLASS 10, CLASS 12, OR CLASS 13	CY	\$8.12	83.23	\$675.83
RS Means Heavy Construction Costs	G1030 115 1000	CUT & FILL COMMON EARTH	CY	\$10.56	55.61	\$587.24
Iowa Public Works Bureau Bid Tabulation Report	7030-C	SHARED USE PATH, PCC, 6"	SY	\$48.20	3189.54	\$153735.83
Iowa Public Works Bureau Bid Tabulation Report	1020-J	SUBBASE, GRANULAR, 6"	SY	\$10.75	3189.54	\$34287.56
Iowa Public Works Bureau Bid Tabulation Report	9010-A	CONVENTIONAL SEEDING, SEEDING, FERTILIZING, AND MULCHING. 1	Acre	\$2451.62	0.727	\$1781.11
Pilot Rock RJ Thomas Mfg. Co.	N/a	100% RECYCLED PLASTIC BENCH – WITH BACKREST. RBB SERIES	EA	\$1000.00	0	\$0.00
RS Means Heavy Construction Costs	32 17 23.13 0604	ACRYLIC WATERBORNE, WHITE, 12" WIDE, LESS THAN 3,000-16,000 LF	LF	\$1.60	1768	\$2828.80
Iowa Public Works Bureau Bid Tabulation Report	8020-K	PAVEMENT MARKINGS REMOVED	STA	\$10.78	0.84	\$9.06
Iowa Public Works Bureau Bid Tabulation Report	8020-G	PAINTED SYMBOLS AND LEGENDS, WATERBORNE OR SOLVENT-BASED	EA	\$102.40	3	\$307.20
Iowa Public Works Bureau Bid Tabulation Report	8020-L	SYMBOLS AND LEGENDS REMOVED	EA	\$88.33	3	\$264.99
Traffic Safety Corp	N/a	BULLDOG III PUSH-BUTTON STATIONS	EA	\$3000.00	1	\$3000.00
					Total	\$202637.78

Mall Trail Cost Estimation						
Reference	Item Code	Bid Item Description	Unit	Unit Price	Quantity	Cost
Iowa Public Works Bureau Bid Tabulation Report	2010-B	CLEARING AND GRUBBING	Acre	\$7102.73	0.058	\$413.67
Iowa Public Works Bureau Bid Tabulation Report	1020-E	EXCAVATION, CLASS 10, CLASS 12, OR CLASS 13	CY	\$8.12	6.28	\$50.99
RS Means Heavy Construction Costs	G1030 115 1000	CUT & FILL COMMON EARTH	CY	\$10.56	5.19	\$54.81
Iowa Public Works Bureau Bid Tabulation Report	7030-C	SHARED USE PATH, PCC, 6"	SY	\$48.20	200.58	\$9667.96
Iowa Public Works Bureau Bid Tabulation Report	1020-J	SUBBASE, GRANULAR, 6"	SY	\$10.75	200.58	\$2156.24
Iowa Public Works Bureau Bid Tabulation Report	9010-A	CONVENTIONAL SEEDING, SEEDING, FERTILIZING, AND MULCHING. 1	Acre	\$2451.62	0.058	\$142.78
Pilot Rock RJ Thomas Mfg. Co.	N/a	100% RECYCLED PLASTIC BENCH – WITH BACKREST. RBB SERIES	EA	\$1000.00	0	\$0.00
RS Means Heavy Construction Costs	32 17 23.13 0604	ACRYLIC WATERBORNE, WHITE, 12" WIDE, LESS THAN 3,000-16,000 LF	LF	\$1.60	248	\$396.80
Iowa Public Works Bureau Bid Tabulation Report	8020-K	PAVEMENT MARKINGS REMOVED	STA	\$10.78	0.84	\$9.06
Iowa Public Works Bureau Bid Tabulation Report	8020-G	PAINTED SYMBOLS AND LEGENDS, WATERBORNE OR SOLVENT-BASED	EA	\$102.40	0	\$0.00
Iowa Public Works Bureau Bid Tabulation Report	8020-L	SYMBOLS AND LEGENDS REMOVED	EA	\$88.33	0	\$0.00
Traffic Safety Corp	N/a	BULLDOG III PUSH-BUTTON STATIONS	EA	\$3000.00	0	\$0.00
					Total	\$12892.30

Total Costs	
Entity	Cost
Agency St. Trail	\$358500.00
Broadway St. Trail	\$202500.00
Mall Trail	\$13000.00
Construction Subtotal	\$574000.00
Easements & Property Acquisition	TBD
10% Contingencies	\$57400.00
20% Engineering & Administration	\$114800.00
Total Project Cost	\$746200.00

PROJECT: CEE: 4850  
DATE: 11/18/2024  
DRAWN BY: Blake Misfeldt  
REVISION:

**THE UNIVERSITY OF IOWA**  
**CIVIL AND ENVIRONMENTAL ENGINEERING**  
4105 SEAMANS CENTER FOR THE  
ENGINEERING ARTS AND SCIENCES  
103 S CAPITOL ST  
IOWA CITY, IOWA 52242  
PHONE: 319.335.5647  
FAX: 319.335.5660  
EMAIL: civil-hawks@iowa.edu



EDUCATIONAL - NOT FOR CONSTRUCTION

**Agency St. Trail Project**

122 Broadway St.  
West Burlington, IA 56255

SHEET NAME

Cost Estimate

SHEET NO.

**C-02**





MATCH LINE - 1  
 AT STATION - 5+38.00  
 NEXT SHEET NUMBER: 2

Gear Ave. to W Walmart Driveway Profile

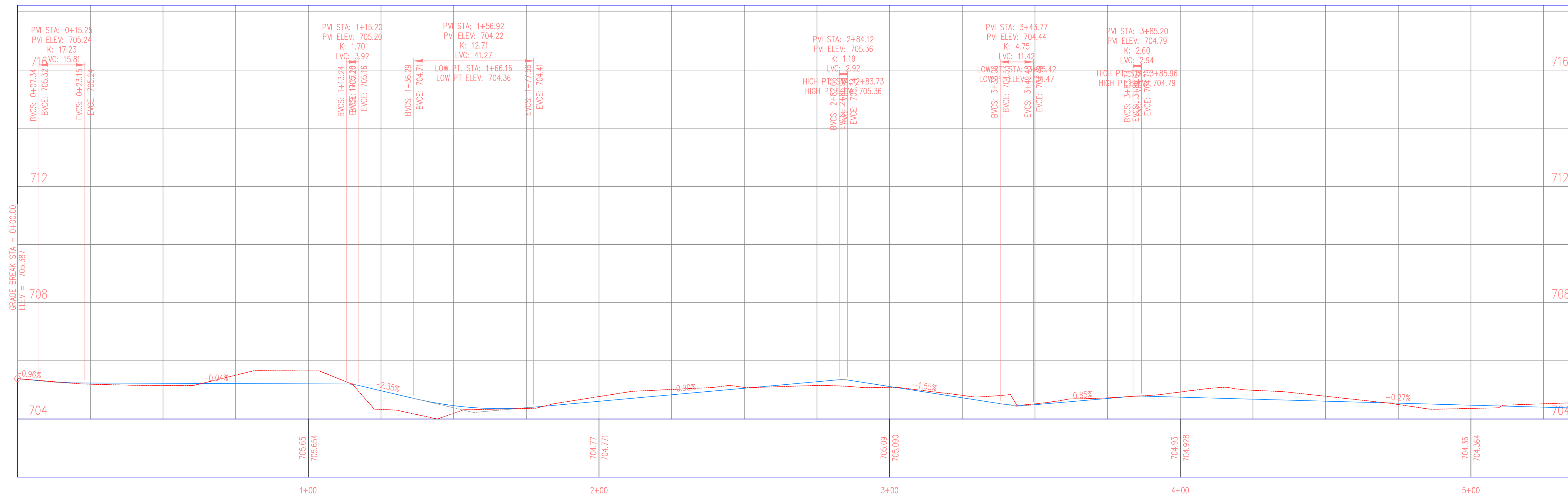

PROJECT: CEE: 4850  
 DATE: 11/18/2024  
 DRAWN BY: Blake Misfeldt  
 REVISION:

**THE UNIVERSITY OF IOWA**  
**CIVIL AND ENVIRONMENTAL ENGINEERING**  
 4105 SEAMANS CENTER FOR THE  
 ENGINEERING ARTS AND SCIENCES  
 103 S CAPITOL ST  
 IOWA CITY, IOWA 52242  
 PHONE: 319.335.5647  
 FAX: 319.335.5660  
 EMAIL: civil-hawks@iowa.edu



EDUCATIONAL - NOT FOR CONSTRUCTION

**Agency St. Trail Project**  
 122 Broadway St.  
 West Burlington, IA 52655

SHEET NAME  
 Gear Ave. to W Walmart Driveway

SHEET NO.  
**D-01**



Intersection - Agency St. and Gas Station  
 Alignment = Gear to W Walmart Driveway, Station 3+26.10  
 Alignment = Gas Station Sidewalk, Station 0+00.00

Gas Station Sidewalk Profile

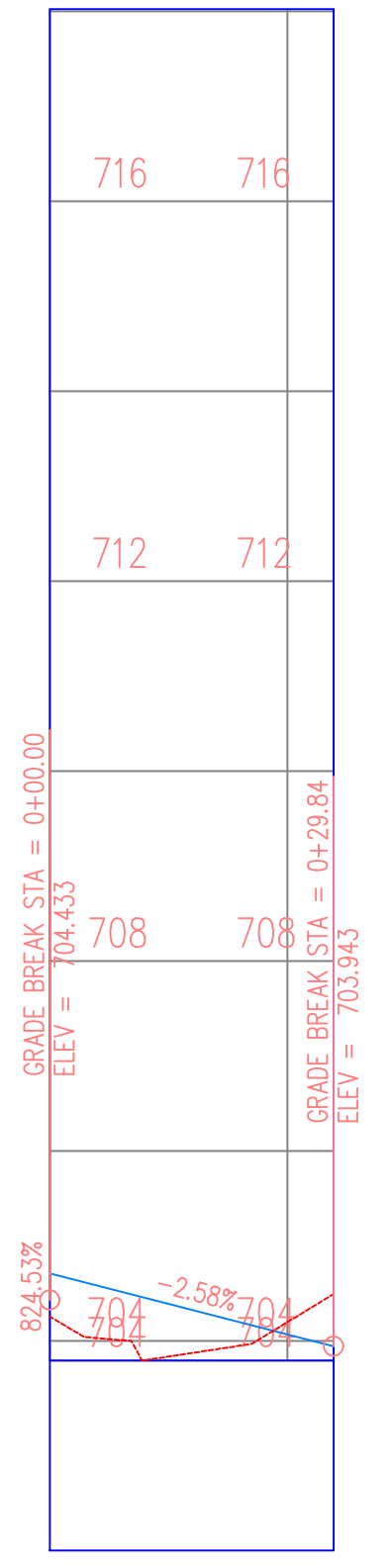

PROJECT:	CEE: 4850
DATE :	11/18/2024
DRAWN BY:	Bloke Misfeldt
REVISION:	

**THE UNIVERSITY OF IOWA**  
**CIVIL AND ENVIRONMENTAL ENGINEERING**  
 4105 SEAMANS CENTER FOR THE  
 ENGINEERING ARTS AND SCIENCES  
 103 S CAPITOL ST  
 IOWA CITY, IOWA 52242  
 PHONE: 319.335.5647  
 FAX: 319.335.5660  
 EMAIL: civil-hawks@iowa.edu



EDUCATIONAL - NOT FOR CONSTRUCTION

**Agency St. Trail Project**

122 Broadway St.  
 West Burlington, IA 52655

SHEET NAME  
 Gas Station Sidewalk

SHEET NO.  
**D-02**

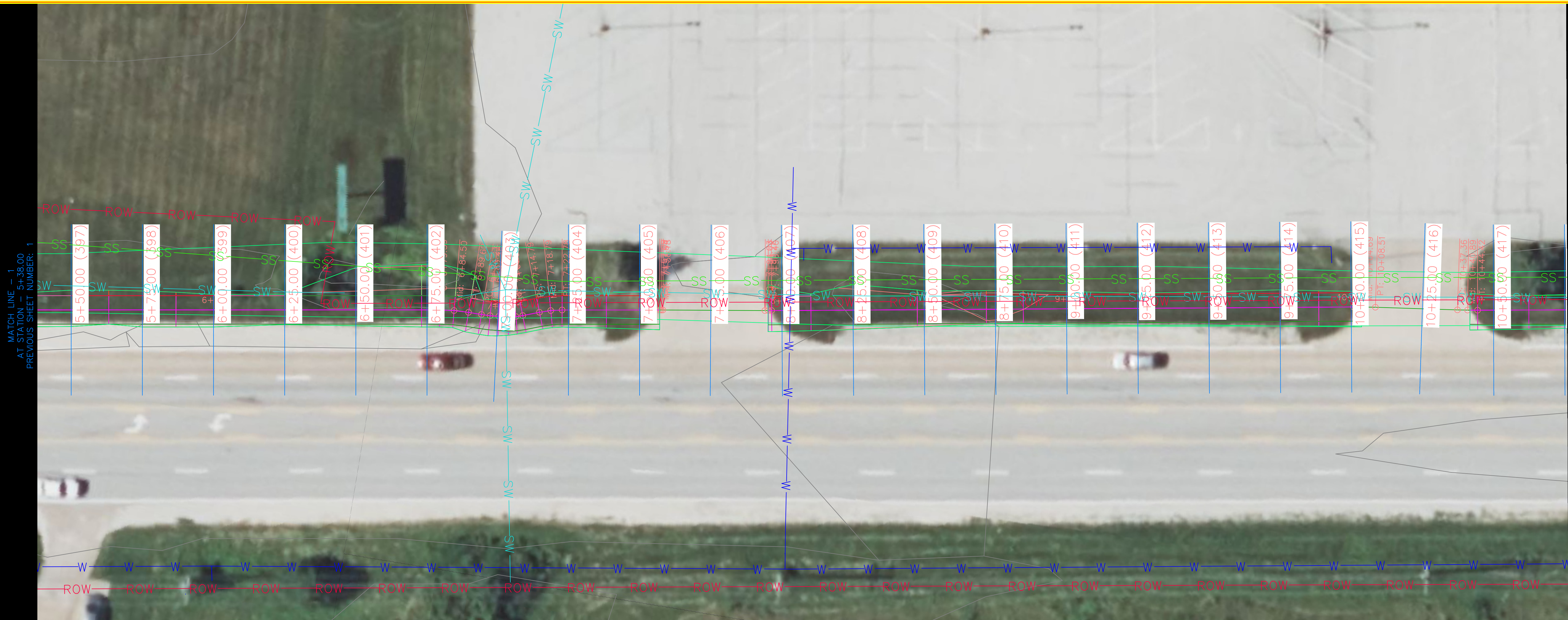

MATCH LINE - 1  
 AT STATION - 5+38.00  
 PREVIOUS SHEET NUMBER: 1

MATCH LINE - 2  
 AT STATION - 10+76.00  
 NEXT SHEET NUMBER: 3

Gear Ave. to W Walmart Driveway Profile

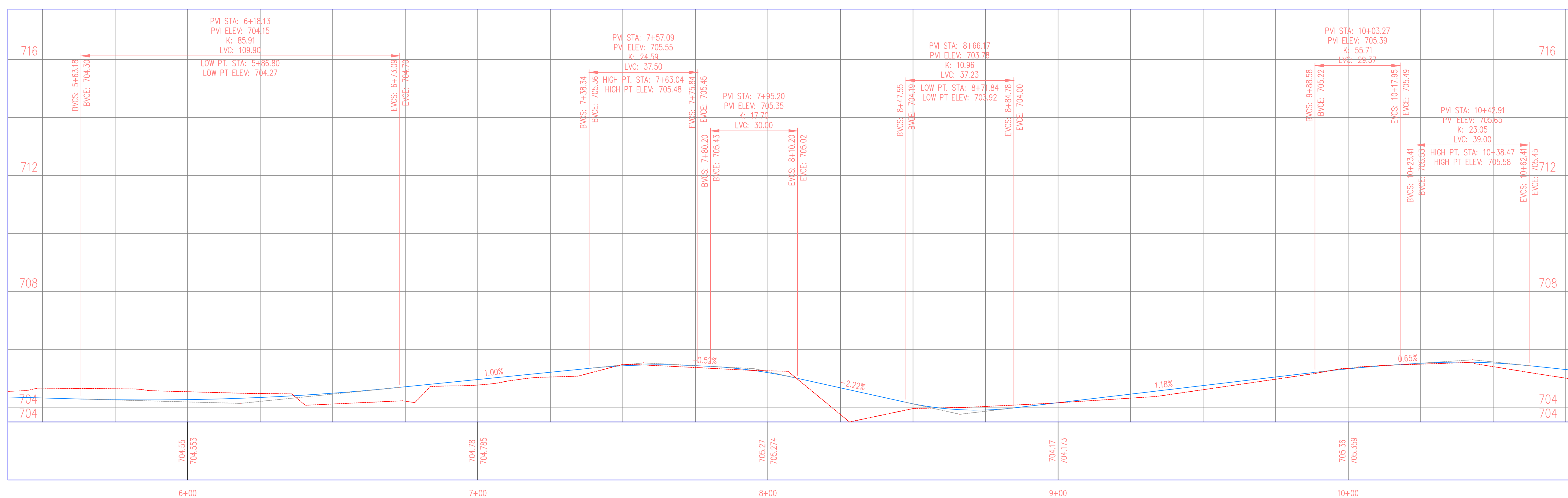

PROJECT:	CEE: 4850
DATE :	11/18/2024
DRAWN BY:	Bloke Misfeldt
REVISION:	

**THE UNIVERSITY OF IOWA**  
**CIVIL AND ENVIRONMENTAL ENGINEERING**  
 4105 SEAMANS CENTER FOR THE  
 ENGINEERING ARTS AND SCIENCES  
 103 S CAPITOL ST  
 IOWA CITY, IOWA 52242  
 PHONE: 319.335.5647  
 FAX: 319.335.5660  
 EMAIL: civil-hawks@iowa.edu



EDUCATIONAL - NOT FOR CONSTRUCTION

**Agency St. Trail Project**  
 122 Broadway St.  
 West Burlington, IA 52655

SHEET NAME  
 Gear Ave. to W  
 Walmart Driveway

SHEET NO.  
**D-03**

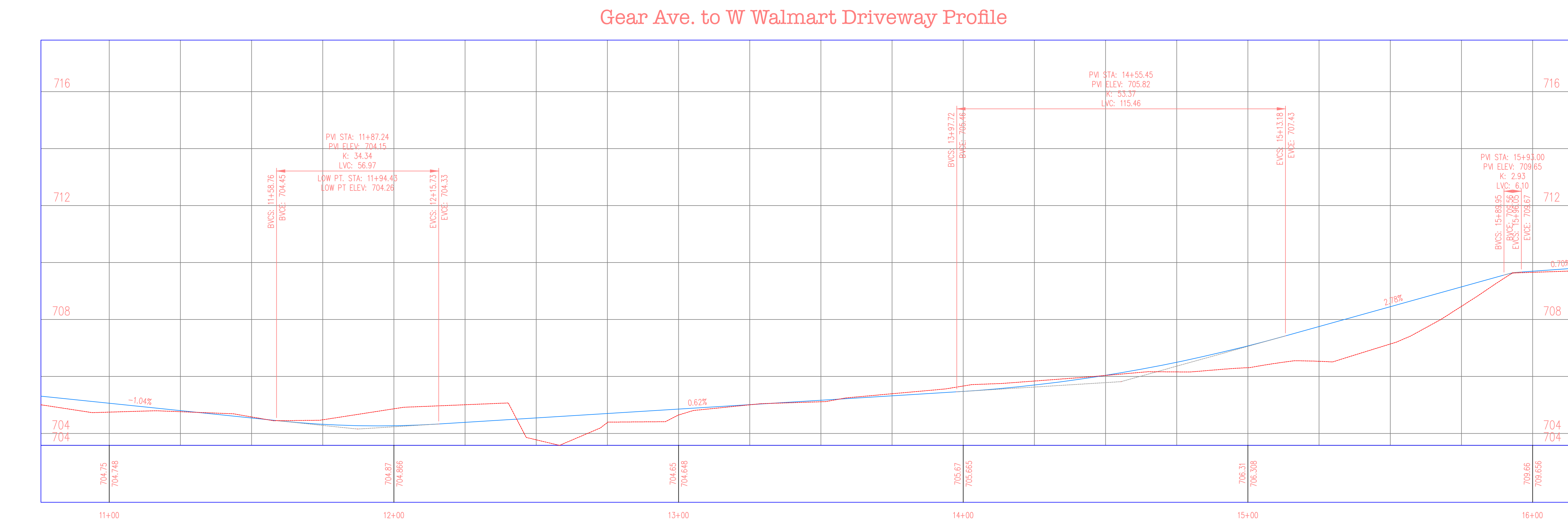

PROJECT: CEE: 4850  
 DATE: 11/18/2024  
 DRAWN BY: Blake Misfeldt  
 REVISION:

**THE UNIVERSITY OF IOWA**  
**CIVIL AND ENVIRONMENTAL ENGINEERING**  
 4105 SEAMANS CENTER FOR THE  
 ENGINEERING ARTS AND SCIENCES  
 103 S CAPITOL ST  
 IOWA CITY, IOWA 52242  
 PHONE: 319.335.5647  
 FAX: 319.335.5660  
 EMAIL: civil-hawks@iowa.edu



EDUCATIONAL - NOT FOR CONSTRUCTION

**Agency St. Trail Project**  
 122 Broadway St.  
 West Burlington, IA 52655

SHEET NAME  
 Gear Ave. to W Walmart Driveway

SHEET NO.  
**D-04**