

CEE:4840 Project Design & Management

White Oak Conservation Restoration

University of Iowa Senior Design

April 29, 2024

Engineering Project Team

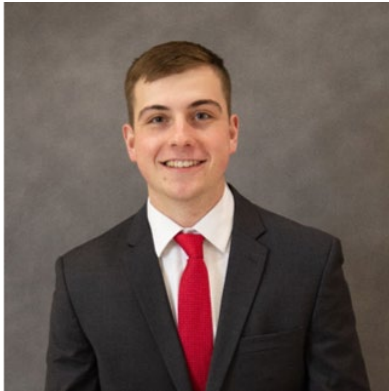

Cody Hall

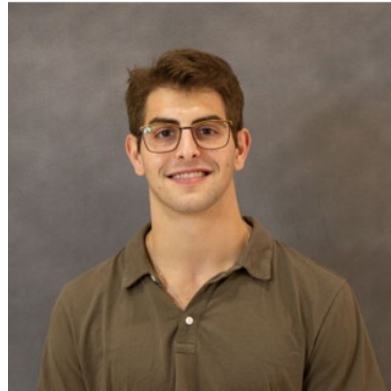

Cory Siegel



Maya Johnson



Noah Lyon



Evan Felts

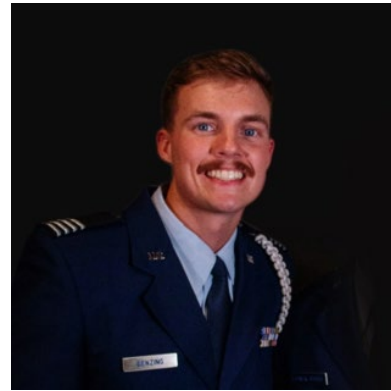

Beau Benzing



Justin Japlon



Aden Gomez

Overview



**Existing
Conditions**



Scope of Work



**Final Design
Solutions**



**Cost, Phasing,
& Funding**

Existing Conditions

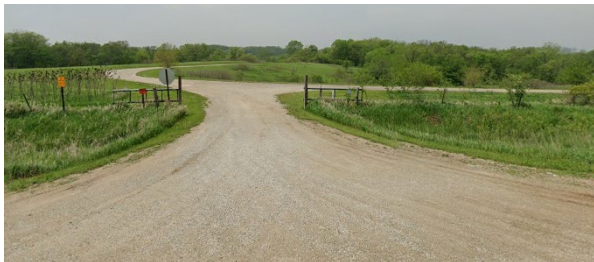

Scope of Work

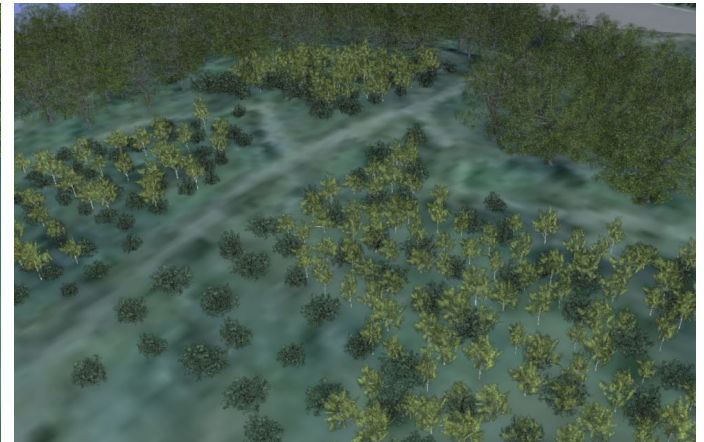
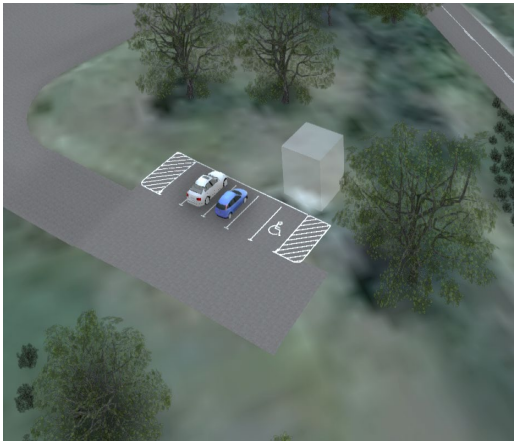
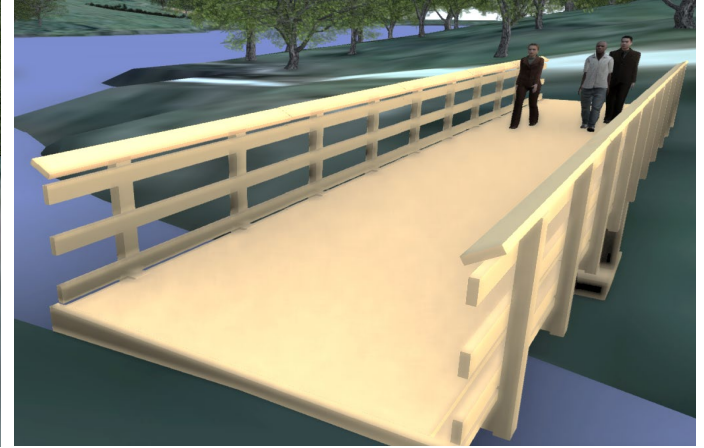
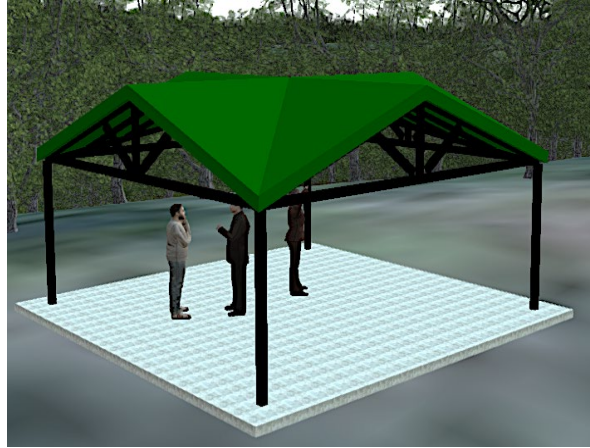

Scope of Work

1. Lake Evaluation & Dredging
2. Pavilions
3. Pedestrian Bridges
4. Roadways
5. Parking Lots
6. Boat Ramp
7. Trails
8. Playgrounds



Lake Evaluation

HEC-HMS Model

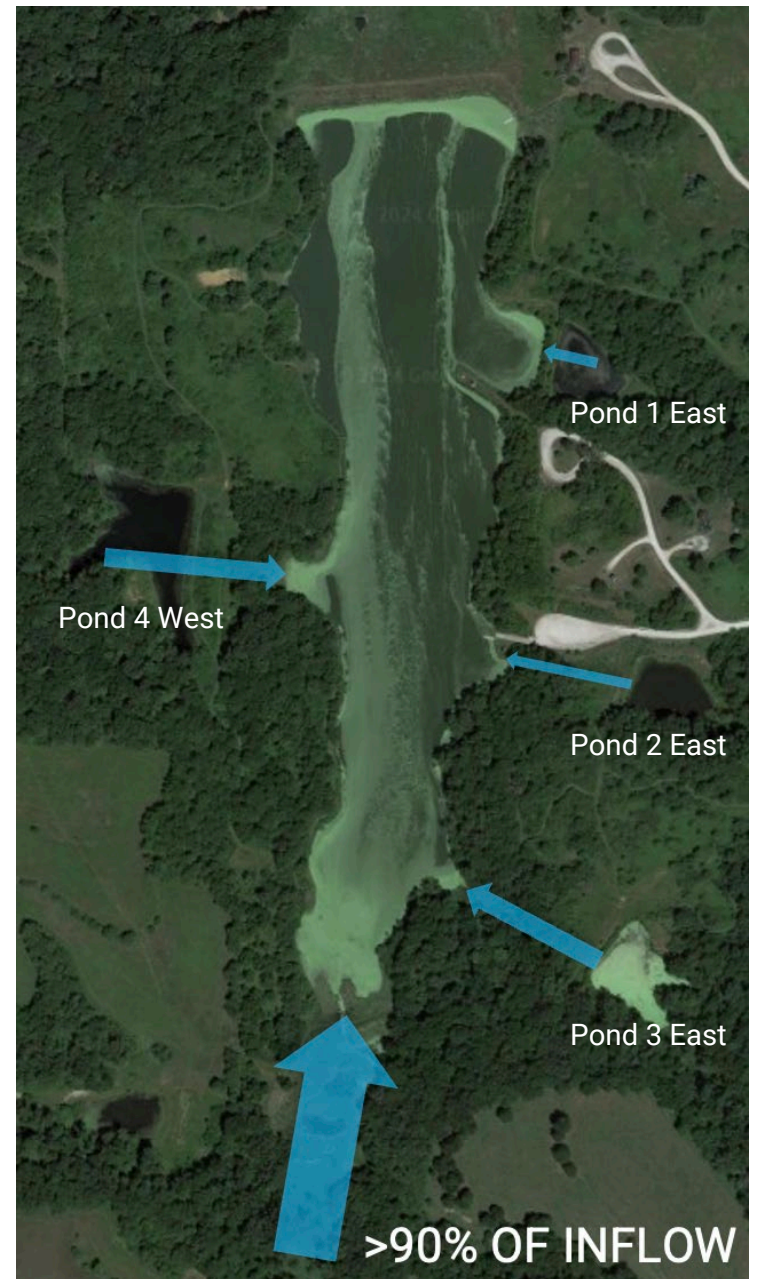
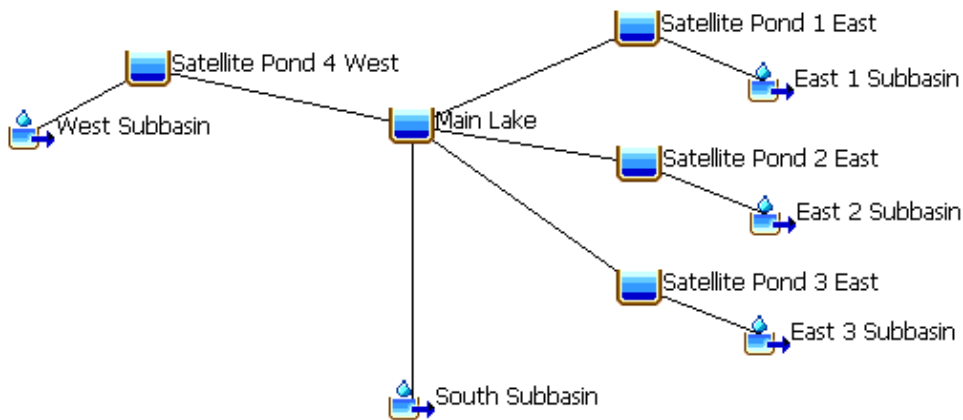

Lake Dredging

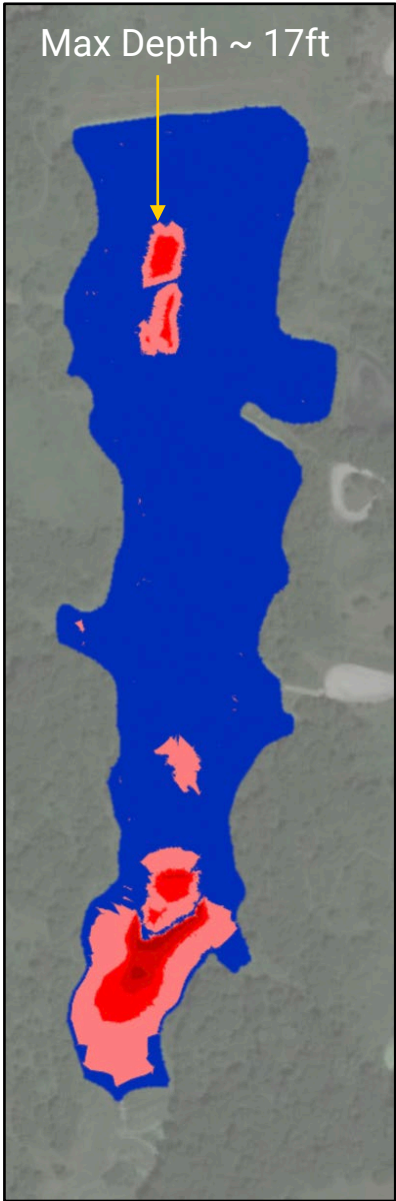
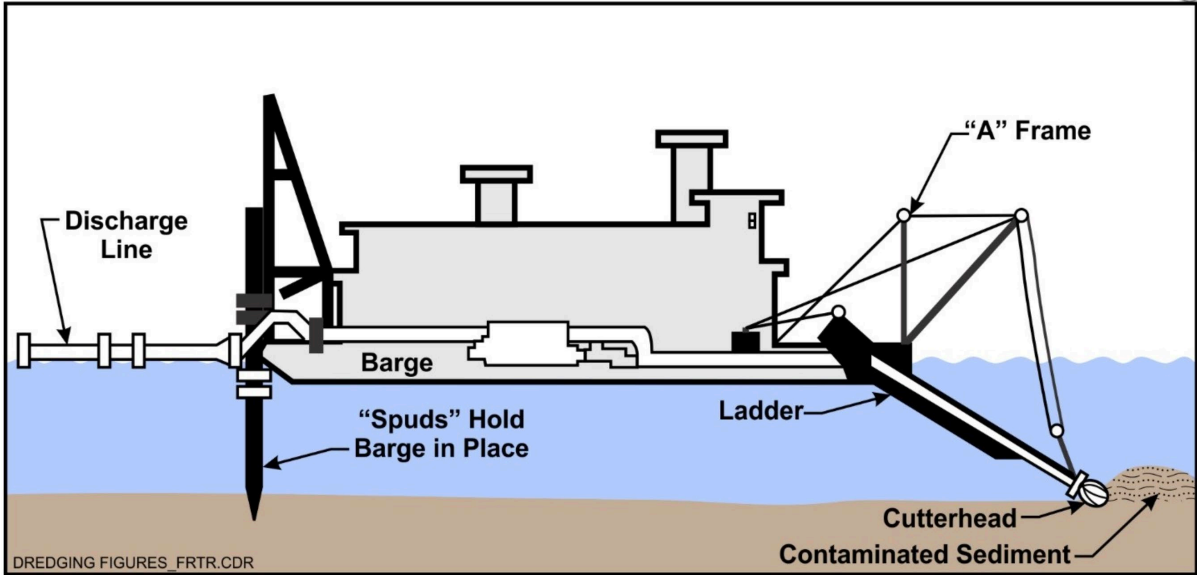

Task	Cost
Hydraulic Dredging (Recommended)	\$43,300
Mechanical Dredging	\$60,000
Dredging Cost	\$43,300

Pavilions



Cardinal Pavilion

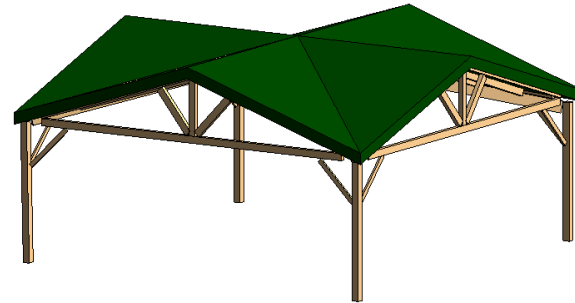

Robin Pavilion

Pavilions

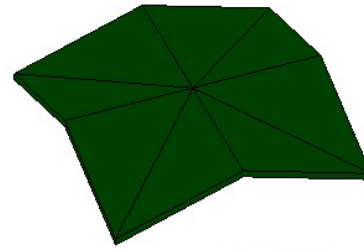
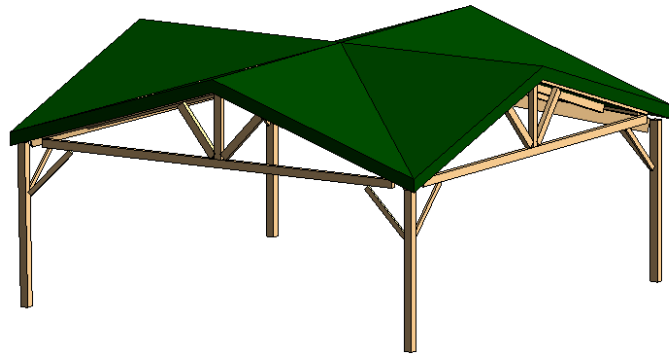

Steel Roof Decking

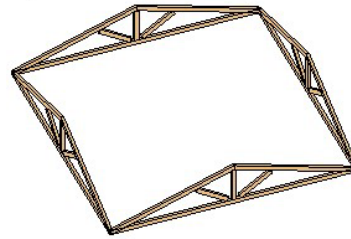

Trusses



Purlins



Girders

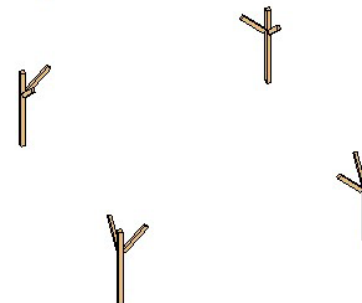

Columns & Bracing

Pavilions

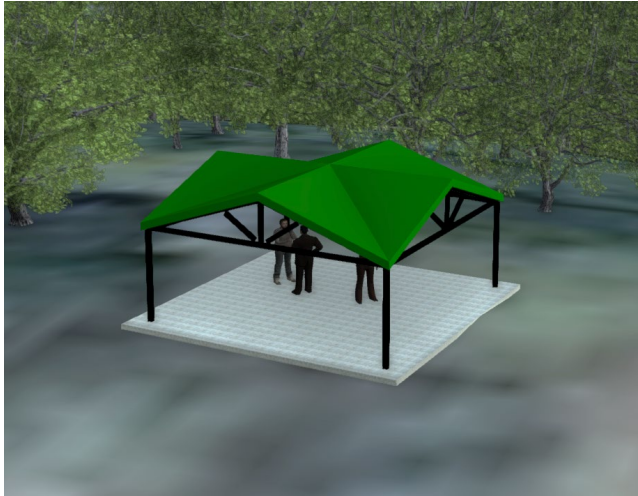

Robin Pavilion

Task	Cost
Materials	\$7,670
Construction	\$17,330
Pavilion Cost	\$25,000

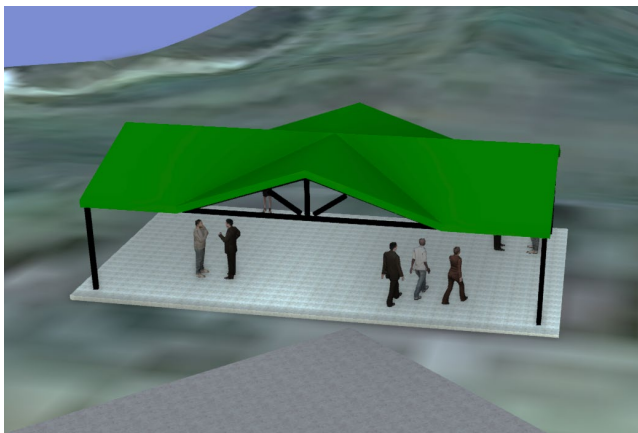

Cardinal Pavilion

Task	Cost
Materials	\$9,450
Construction	\$23,500
Pavilion Cost	\$32,950

Pedestrian Bridges



Boat Ramp Bridge



Southeast Bridge

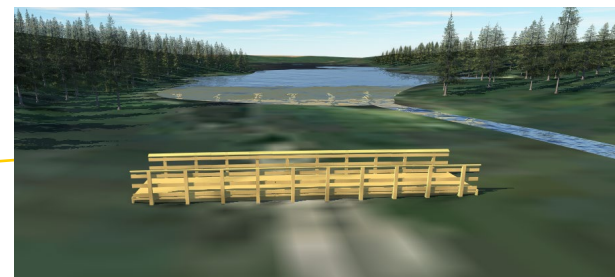

Primary Inlet Bridge

Pedestrian Bridges

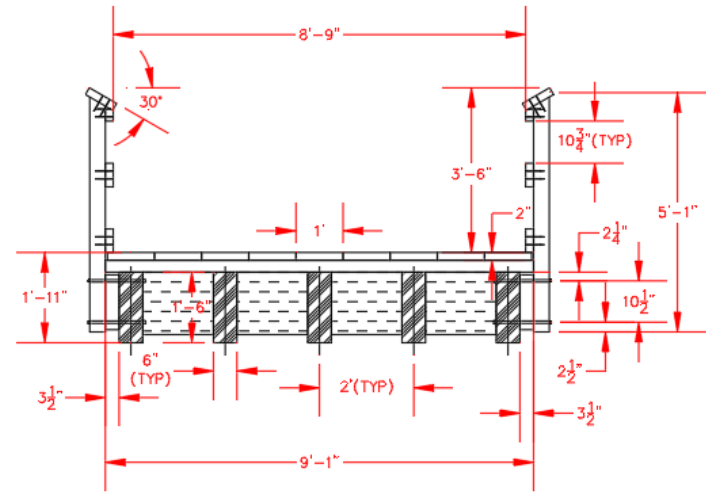
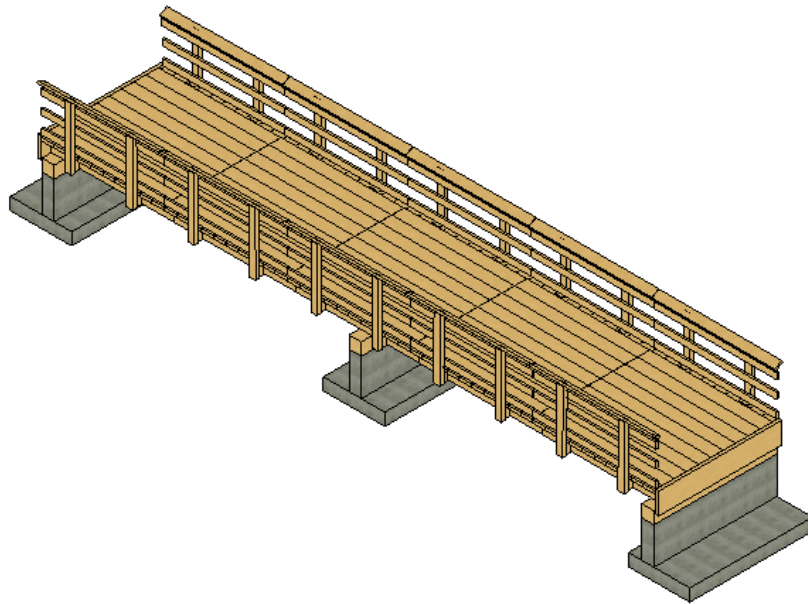

Pedestrian Bridges

**Boat Ramp
Bridge**

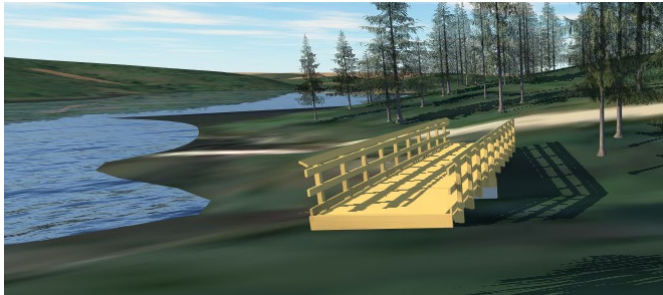

Task	Cost
Materials	\$23,600
Construction	\$18,600
Bridge Cost	\$42,200

**Southeast
Bridge**

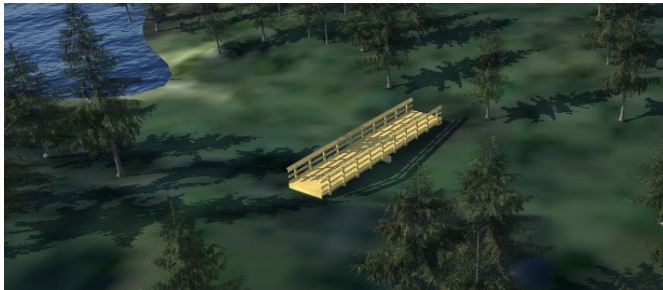

Task	Cost
Materials	\$19,700
Construction	\$18,600
Bridge Cost	\$38,300

**Primary
Inlet
Bridge**



Task	Cost
Materials	\$13,700
Construction	\$17,100
Bridge Cost	\$30,800

Roadways

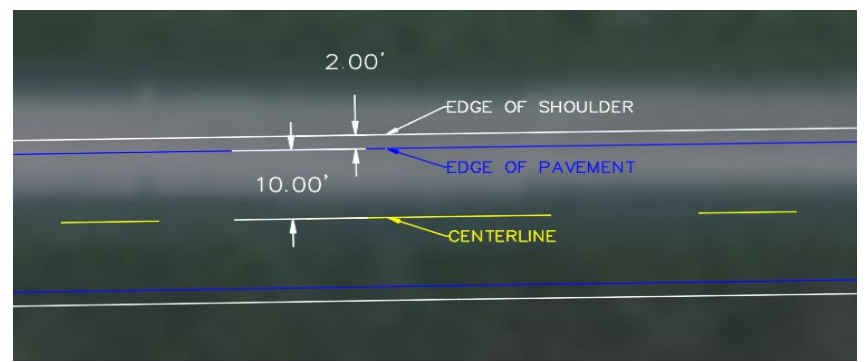

Roadways

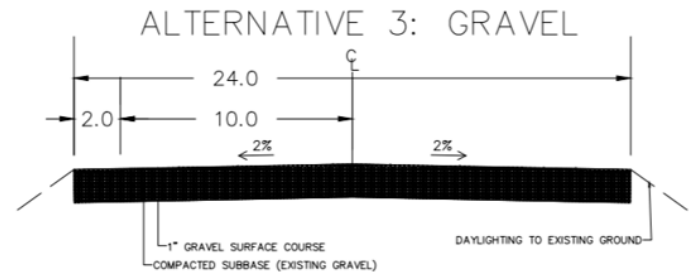
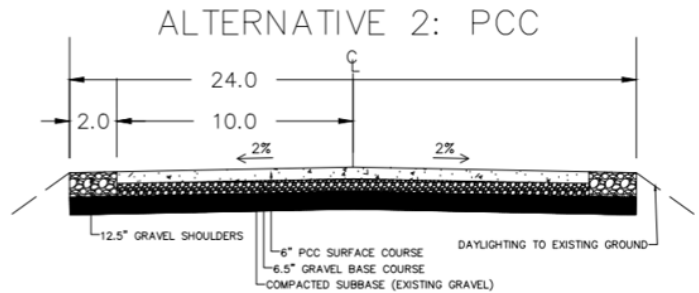
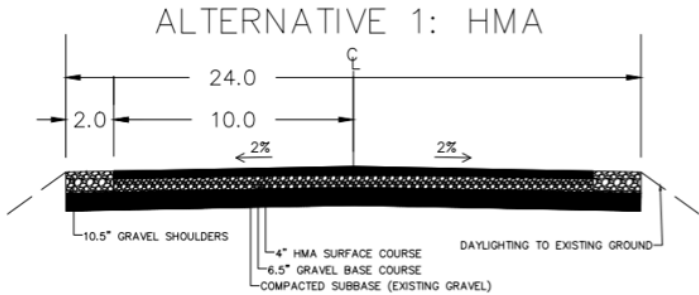

Task	Cost
Excavation	\$134,890
Pavement	\$259,090
Roadway Cost	\$393,980

Recommended option

Task	Cost
Excavation	\$132,890
Pavement	\$421,890
Roadway Cost	\$554,780

Task	Cost
Excavation	\$315
Stone	\$13,150
Roadway Cost	\$13,465

Parking Lots

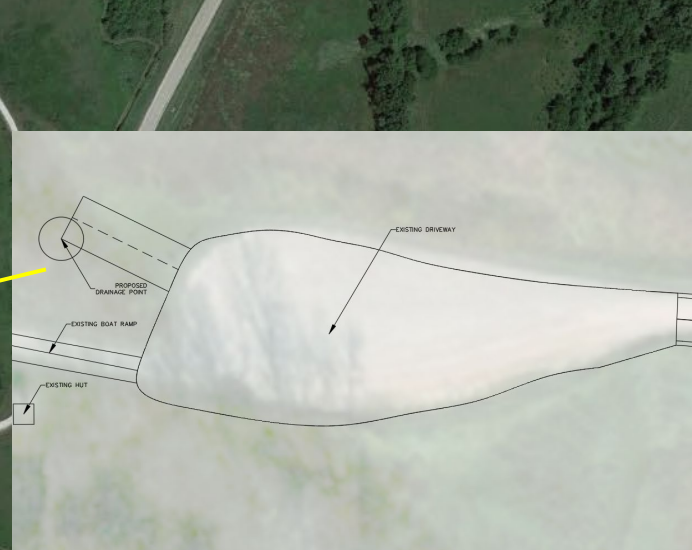
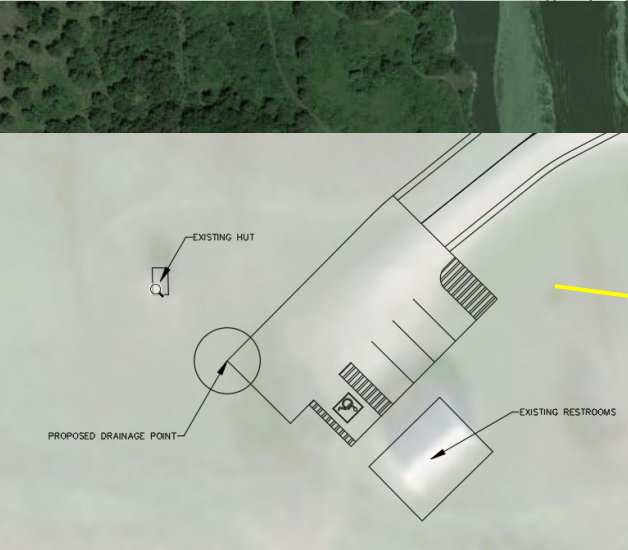
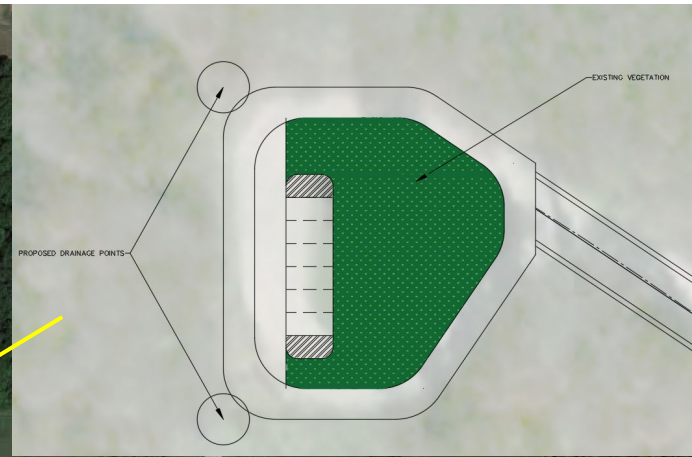
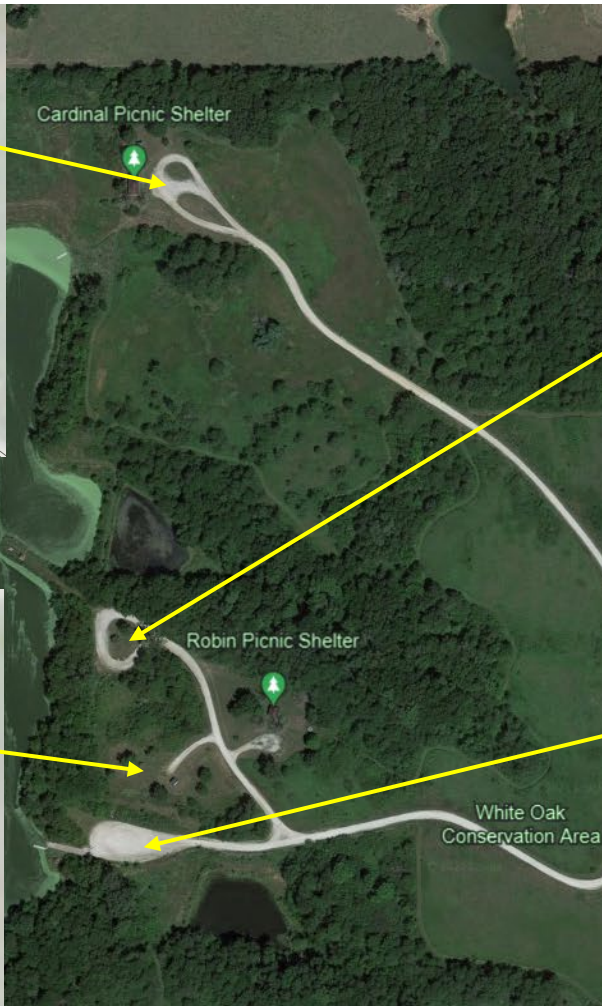
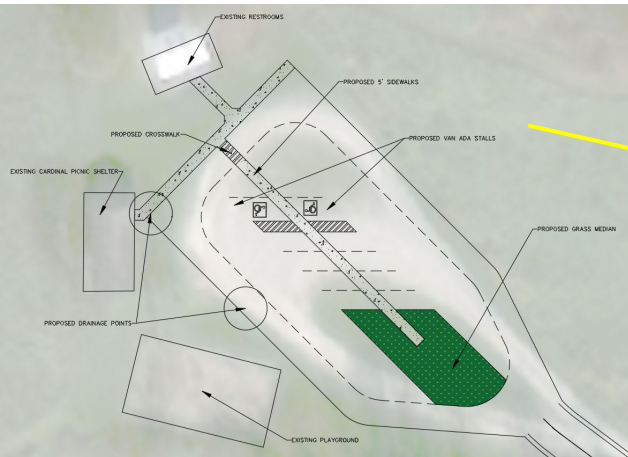

Parking Lots



Alternative 1: HMA



Alternative 2: PCC

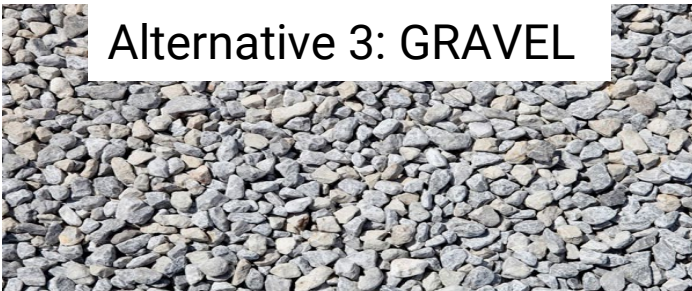

Alternative 3: GRAVEL

Task	Cost
General	\$2,500
Excavation	\$153,975
Pavement	\$156,264
Sidewalk	\$14,100
Parking Lot Cost	\$326,839

Recommended option

Task	Cost
General	\$2,500
Excavation	\$153,975
Pavement	\$233,764
Sidewalk	\$14,100
Parking Lot Cost	\$404,339

Task	Cost
General	\$2,500
Excavation	\$103,975
Stone	\$13,410
Sidewalk	\$230
Parking Lot Cost	\$120,115

Boat Ramp



Task	Cost
Operator	\$250
Telehandler Rental	\$650
Boat Ramp Cost	\$900

Trail System

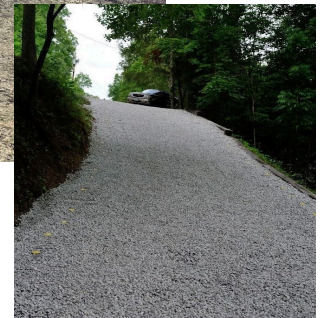
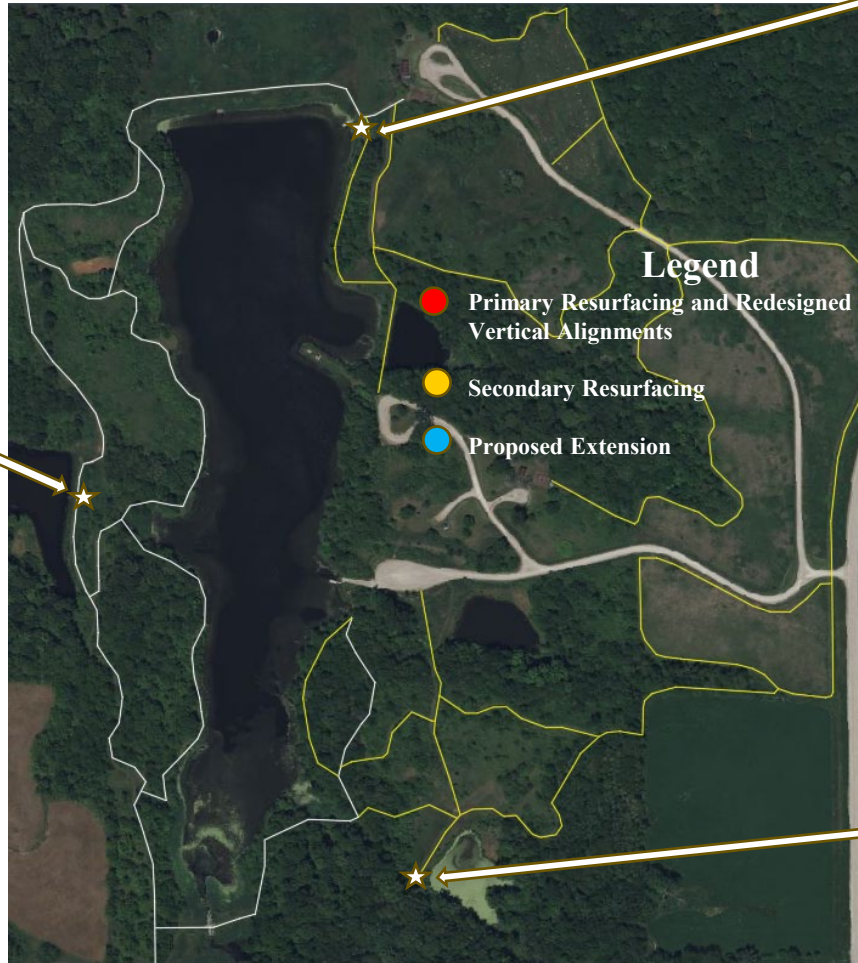

Trail System

Alternative 1: Main High-Use Trails



Task	Cost
Excavation	\$7,370
Crushed Stone	\$15,500
Trail Cost	\$ 22,870

Alternative 2: Main, Secondary, and Extension Alt. 1



Task	Cost
Excavation	\$7,370
Crushed Stone	\$26,800
Trail Cost	\$ 34,170

Alternative 3: Main, Secondary, and Extension Alt. 2



Task	Cost
Excavation	\$7,370
Crushed Stone	\$28,800
Trail Cost	\$36,170

Playgrounds



Task	Cost
Concrete Cornhole	\$1,500
Concrete Ladder Toss	\$1,200
Demolition of Existing	\$2,250
Playground Cost	\$4,950

Total Cost Estimate

Task	Cost
Lake Dredging	\$43,300
Pavilions	\$57,950
Pedestrian Bridges	\$111,300
Roadways	\$393,980
Parking Lots	\$326,839
Boat Ramp	\$900
Trails	\$34,170
Playgrounds	\$4,950
Contingency (20%)	\$194,680
Total Project Cost	\$1,168,080

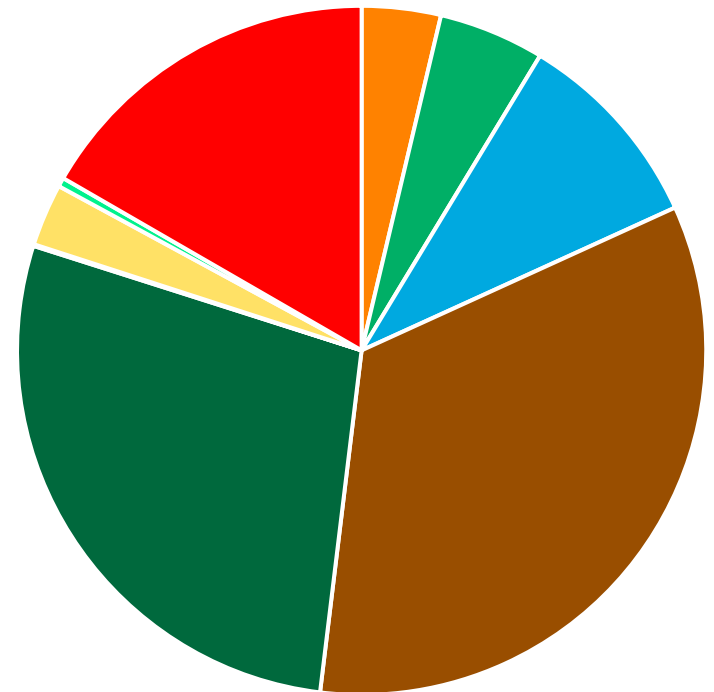

Recommended Phasing

Phase 1



Task	Cost
Lake Dredging	\$43,300
Cardinal Pavilion	\$32,950
Robin Pavilion	\$25,000
Boat Ramp Bridge	\$42,200
Southeast Bridge	\$38,300
Contingency (20%)	\$36,350
Phase 1 Cost	\$218,100

Phase 2



Task	Cost
Boat Ramp Cleanup	\$900
South Road	\$132,228
South Parking Lot	\$107,738
Main High Use Trails	\$22,870
Contingency (20%)	\$52,747
Phase 2 Cost	\$316,483

Phase 3

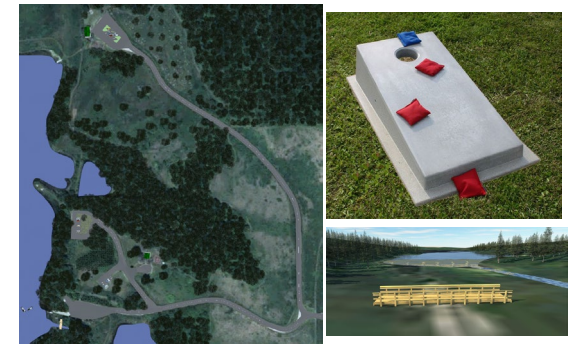

Task	Cost
Remaining Roads	\$261,752
Remaining Parking Lots	\$219,101
Primary Inlet Bridge	\$30,800
Secondary Trails	\$11,300
Playgrounds	\$4,950
Contingency (20%)	\$105,580
Phase 3 Cost	\$633,483

Funding

Iowa Wildlife
Habitat Stamp Fund



FUND DISTRIBUTION

\$350,000 CONSERVATION EDUCATION & 1% ADMINISTRATION

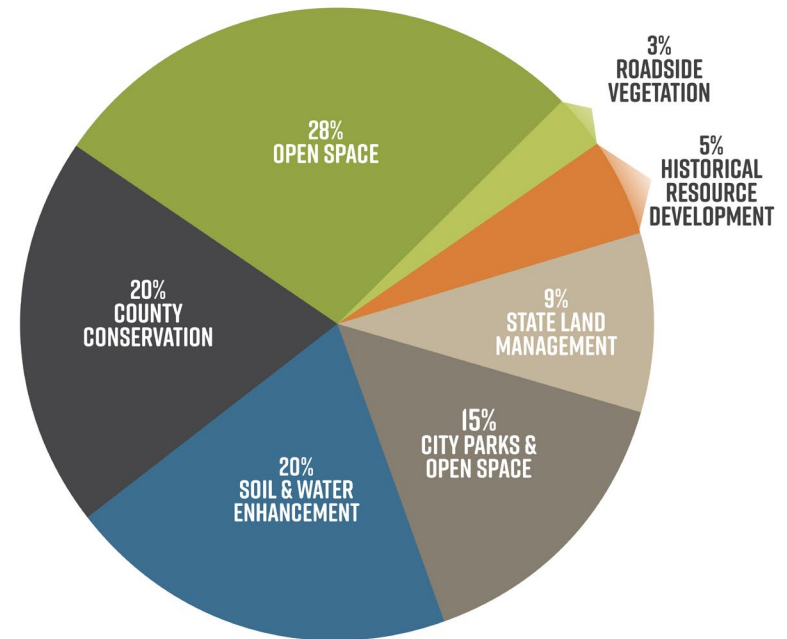

Questions?

