



Bondurant
Life Connecting

Trailhead and Trail Improvements

Teddy Kaepfel, Jordan Utesch, Jacob Peterson, and Bradley Beadle

CEE:4850:0001

Department of Civil and Environmental Engineering

December 2023

Contents

Section I: Executive Summary..... 2

Section II: Organization Information..... 6

 1. Organization and Design Team Description..... 6

Section III: Design Services..... 7

 1. Project Scope 7

 2. Work Plan 7

Section IV: Constraints, Challenges, and Impacts 8

 1. Constraints 8

 2. Challenges..... 9

 3. Societal Impact within the Community 9

Section V: Alternative Solutions That Were Considered 10

Section VI Final Design Details 11

 1. Pedestrian Trail 11

 2. Trailhead Parking..... 13

 3. Food Truck Parking & Plaza..... 13

 4. Lincoln Street..... 15

 5. Bridge Design 15

 i. Hydraulic Design 16

 ii. Abutments..... 17

 iii. Riprap Design 18

 6. Arboretum 19

Section VII Engineer’s Cost Estimate 20

Appendix A – Trail Design..... 22

Appendix B – Food Truck Park & Plaza Design..... 22

Appendix C – Lincoln Street Design 22

Appendix D – Bridge Design..... 22

Appendix E – Hydrology Design..... 22

Appendix F – Abutment Design 41

Appendix G – Arboretum Design..... 47

Section I: Executive Summary

The City of Bondurant requested a design that would relocate the existing trail in two areas—the West Site (see Figure 1) and the East Site (see Figure 3). These trails are being relocated to provide safer, more direct routes, and to enhance the experience for trail users and the community. In addition to the trail, a food truck park, plaza, trailhead parking, an arboretum, and streets are being added to the West Site. A new bridge and trail will be located on the East Site. Both sites are privately owned by Landus Cooperative, which has ceased the use of the railroad in this area. There is an existing railroad bridge in the East Site that has deteriorated and is not safe for pedestrians to use. The city has requested it be replaced with a pedestrian bridge or box culvert.

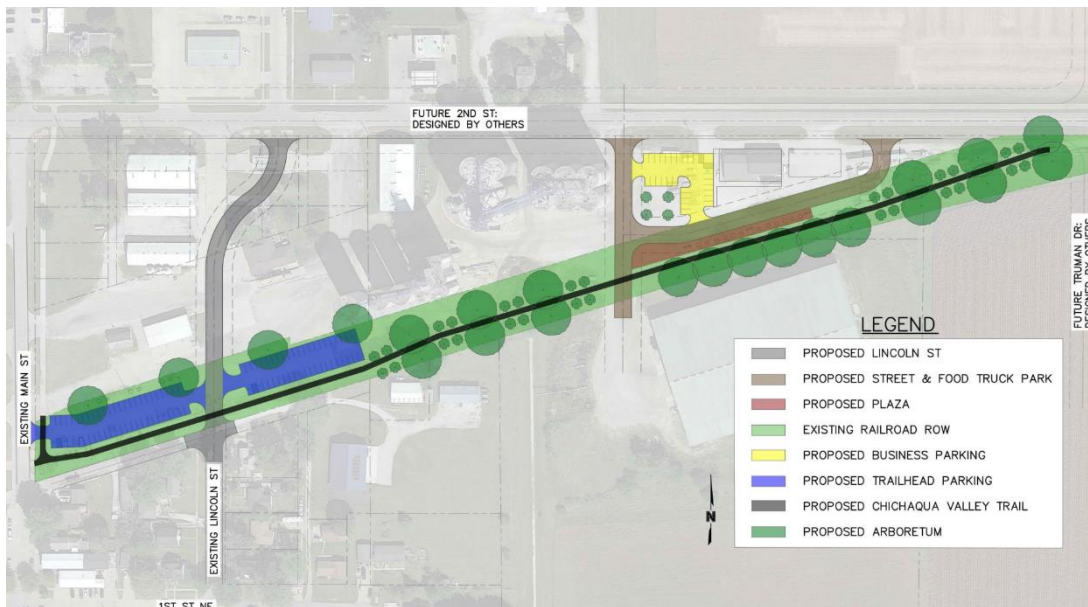

Figure 1. West Site Location

A team of four Civil Engineering students at the University of Iowa designed improvements to the Chichaqua Valley Trail. The design for this trail followed the Iowa Statewide Urban Design and Specifications (SUDAS), American Association of State Highway and Transportation Officials (AASHTO), and Iowa Department of Transportation (IDOT) standards for a 10-foot-wide trail with 6-inch-thick Portland Cement Concrete (PCC) pavement, and 18 MPH design speed. The design aligns the trail within the existing railroad corridor and helps create a safer option for pedestrian use on this trail. These new Chichaqua Valley Trail routes approximately match the existing grade to prevent extra construction or fill requirements.

The design for the trailhead parking (Figure 1) followed SUDAS. Additional parking is provided on the west side of the West Site. This parking provides 91 parking stalls with four ADA-compliant parking spaces in total. The driving lanes of these parking lots will consist of PCC pavement and the parking stalls will consist of permeable pavers.

The extension of Lincoln St., from Railroad St. to 2nd St., is included in this design to allow for access to the proposed trailhead parking. The trail will cross the Lincoln St. extension just north of Railroad St. Iowa DOT, SUDAS, and AASHTO were all standards used to make decisions for the 31' wide, 7" thick Lincoln Street.

A food truck park and plaza (Figure 2) was designed around an existing business and parcel to create a space for recreational benefits. Thirty-one-foot PCC roads were designed for the food truck park to allow vehicles to park along the plaza, while allowing 2-way traffic to continue on the road. Twenty-seven parking stalls and one ADA-compliant stall was designed for the existing business. The driving lanes are PCC pavement, and the parking stalls are permeable pavers. This area will provide the community with a wide selection of food options. Also along this location is the option for a potential site for a basketball or pickleball court.

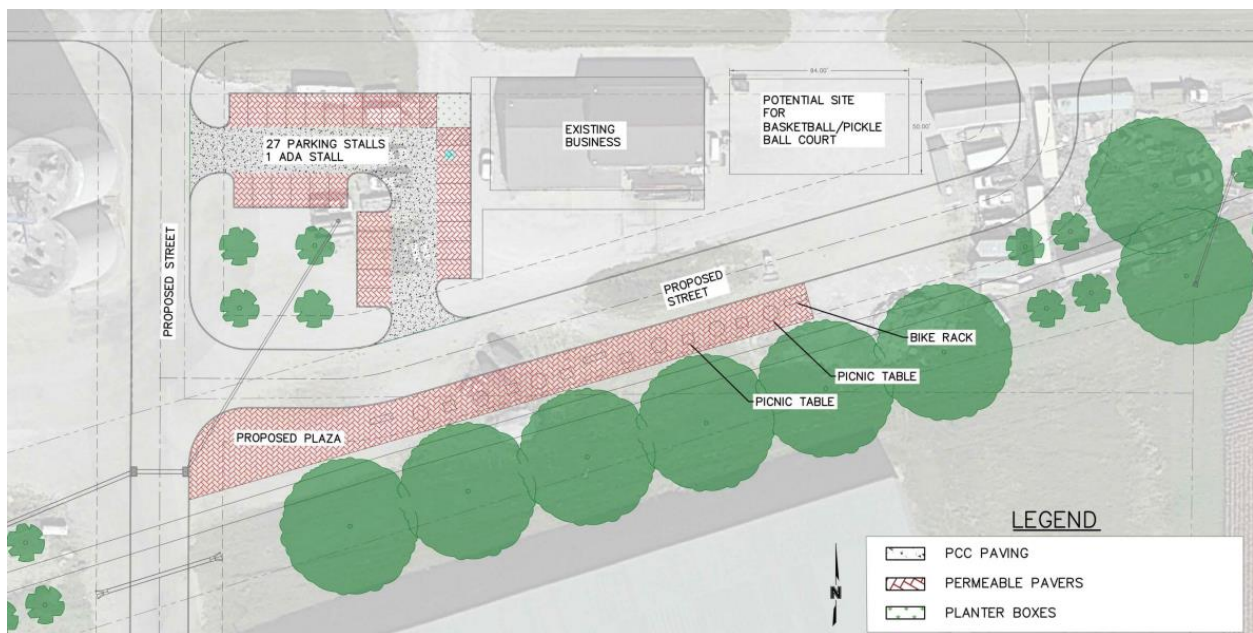

Figure 2. Plaza, Parking, Food Truck, and Potential Sport Court (West Site)

An arboretum filled with overstory and ornamental trees was designed to run along the bike trail corridor from the trailhead parking to the future intersection of 2nd St. and Truman Dr. (Figure 1). The city has diverse species of trees, and the design selection maintains species native to Iowa. The ornamental trees selected are prairie crabapples and eastern redbuds. The overstory trees selected from the Iowa DNR list are shagbark hickory, sycamores, black oaks, and white oaks.

On the East Site, a prefabricated pedestrian bridge was designed to cross Santiago Creek (see Figure 3). The bridge is 14' wide to accommodate pedestrians, cyclists, lawnmowers, emergency vehicles, and snow removal. The proposed bridge superstructure is a prefabricated Pratt truss design from Bridge Brothers or approved equal provided by another manufacturer. The bridge has one span of 45' long and 6" concrete decking. (Figure 4)

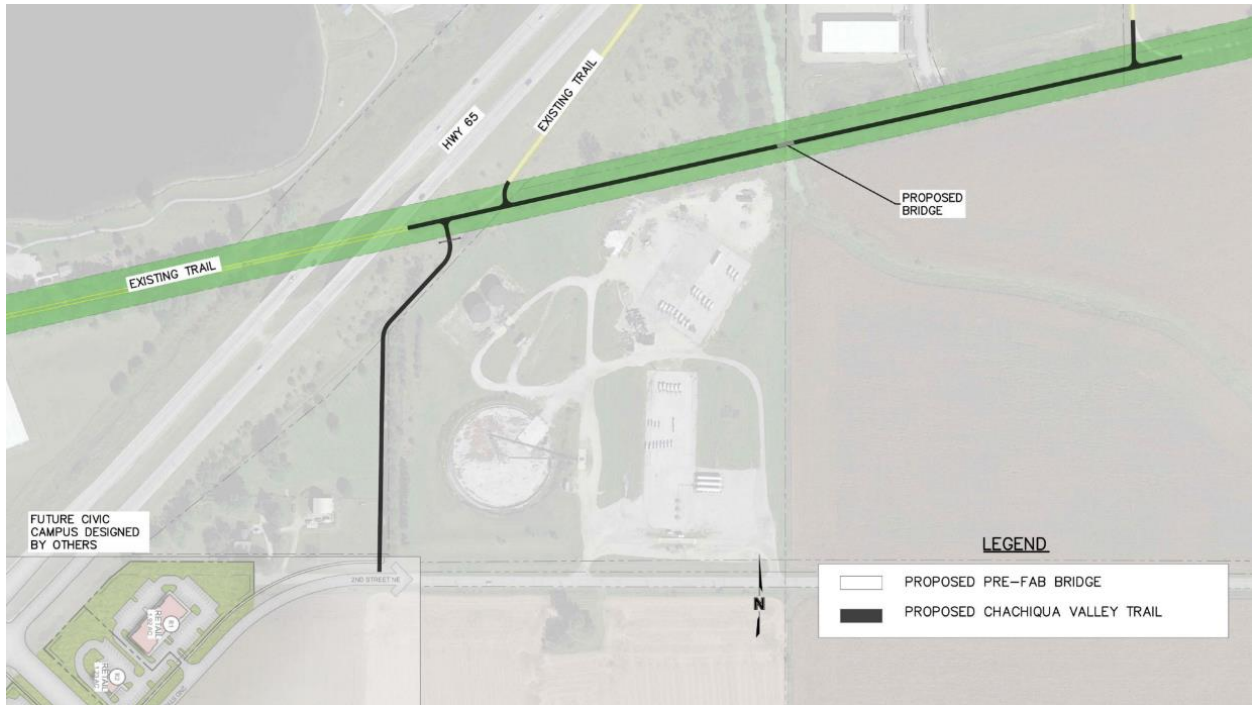

Figure 3. East Site Location

Reinforced concrete abutments support the bridge on each side of the creek. The abutments were designed using a proportional dimension method, using the required height from the top of the bridge decking to a depth of two-feet below the estimated channel bottom. After dimensions were determined, they were tested for overturning, uplift, and bearing capacity failure with and without the weight of the bridge to ensure structural stability.

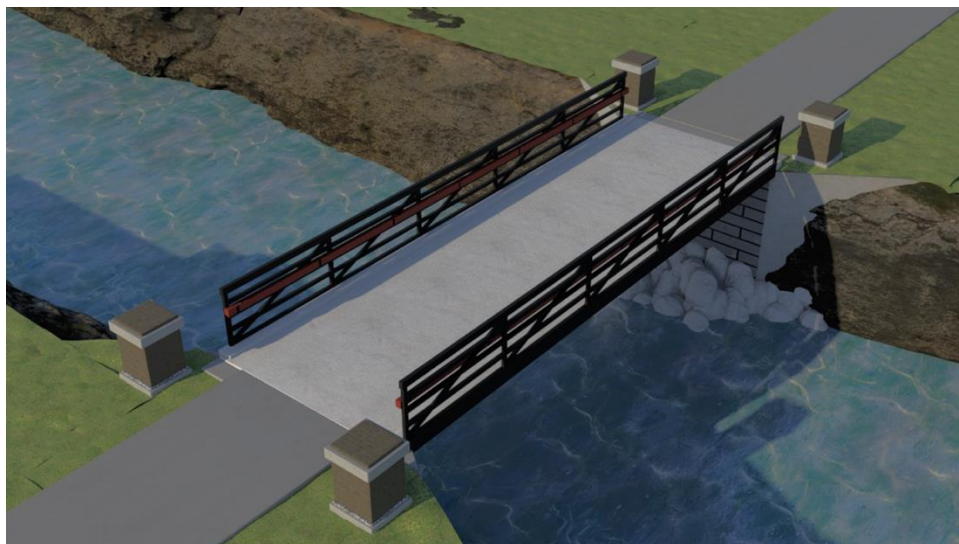

Figure 4. Render of Proposed Bridge

Hydrologic design considerations ensure that the bridge can withstand applicable flood scenarios, freeboard, and backwater required by Iowa DOT and Iowa DNR. The design

freeboard for the proposed bridge is 4.86' above the 50-year flood, which is more than the required 3' above the 50-year flood. This will allow ample space for floating debris to pass under the bridge during a flood event. The backwater 150' upstream will be 6.72" higher due to the proposed bridge, while the maximum value allowed is 1.5' for a 100-year flood.

The construction cost estimate was separated into the two locations--West and East Sites. The unit prices include the cost of material, labor, equipment, overhead, profit, and final design. The unit prices were pulled from similar projects from the Iowa DOT Bid Tabs and Olsson Associates Bid Tabs. A 10% contingency was added to the project totals to allow for any circumstances that may arise during construction that could not have been predicted with certainty.

West Site total estimated cost: \$1,951,000.

East Site total estimated cost: \$876,000.

Total project estimated cost: \$2,827,000.

Section II: Organization Information

1. Organization and Design Team Description

This project was completed by a team of senior civil engineering students at the University of Iowa in Project Design and Management.

Teddy Kaepfel, the project manager, has a focus area in civil and structural engineering. Teddy has relevant experience through previous internships at Nucor Buildings Group and the City of Iowa City. While at Nucor Buildings Group, Teddy has designed and modeled metal structures using a series of software in accordance with International Building Code (IBC) and American Society of Civil Engineering (ASCE) code.

Jordan Utesch, the software/AutoCAD lead, has a focus area in civil and transportation engineering. Jordan has relevant experience through previous internships at H&H Builders Inc and Olsson Associates. While at Olsson Associates, Jordan developed and designed plans for multiple projects, including residential, commercial, and recreational developments. Jordan also had lead roles in solving drainage issues in South Sioux city with survey and Civil3D to redesign existing pipe networks.

Jacob Peterson, the project production coordinator, has expertise in civil and structural engineering. Jacob has relevant experience through previous internships at the City of Moline for multiple summers. While at the City of Moline, Jacob has assisted in designing and preparing construction plans for public infrastructure projects using Civil3D software. As well as conducting field surveys and gathering data for multiple projects.

Bradley Beadle, the report production editor, has a focus area in civil engineering and pre-architecture. Brad has relevant experience through previous internships at Veenstra & Kimm and Shive-Hattery. While at Veenstra & Kimm, Brad has assisted in conducting site assessments and surveys to evaluate existing infrastructure.

Section III: Design Services

1. Project Scope

The project includes relocation of two portions of the Chichaqua Valley Trail, which is located at the West Site and the East Site in Bondurant, Iowa.

The trail on the West Site will have a paved ADA-compliant surface that will start at the existing trailhead located at the West Site on Main St SE and extend to 2nd St NE to the existing Chichaqua Valley Trail. Parking spaces for the trailhead will be included on the east side of the West Site. Lincoln Street will be extended north and south near the east parking lot. The parking lot will have the option for permeable pavement on all the parking stalls (Figure 1).

Along the trail will be an arboretum with a variety of trees. At the northeast end of the West Site will be a plaza with more parking spaces for a business located adjacent to it. This plaza provides an area for the community to gather and includes potential food truck parking, as well as the possible addition of a basketball or pickleball court on the east side (Figure 2).

The East Site will provide a paved ADA-compliant trail that will begin at the existing trail and continue east to connect to another end of Chichaqua Valley Trail. In between these segments is a deteriorated bridge that requires replacement. This trail also provides a connection from the existing trail to the future civic campus plan located south of the East Site (Figure 3).

2. Work Plan

The work plan (Table 1) includes the main components of the project and additional tasks, listed with start and end dates. Teddy was the project manager and ensured each task was delegated to specific or multiple design team members based on previous work and related experiences. He also led the team in bridge and abutment designs. Jordan had trail design experience and worked to gather trail information. Jordan focused on the design alternatives for the parking, plaza, and trail routes. Jacob led the team's arboretum research and the final arboretum design. Brad focused on flood analysis and hydrological impacts of the bridge design. The team worked together on the deliverables and revising of the reports, presentation, and poster.

TASK	LED BY	PROGRESS	START	END
Trail Design		Jordan & Teddy		
Gather GIS Data		100%	9/11/23	9/18/23
Gather Trail Information		100%	9/18/23	9/25/23
Determine Alternative Routes		100%	9/25/23	10/9/23
Determine Alternative Parking		100%	10/9/23	10/23/23
Design Alternative Plaza Options		100%	10/9/23	10/23/23
Finalize Trail Design		100%	10/23/23	11/17/23
Arboretum Design		Jacob		
Gather Tree Options		100%	9/25/23	10/9/23
Determine Tree Species and Detail		100%	10/9/23	10/23/23
Arboretum Arrangement Design		100%	10/23/23	12/8/23
Flood Analysis		Brad		
Gather Stream Data		100%	9/11/23	9/18/23
Determine Culvert Length		100%	9/18/23	9/25/23
Calculate Flows & Backwater		100%	9/25/23	10/16/23
HEC-RAS Water Analysis		100%	10/16/23	11/13/23
Bridge and Abutment Design		Jacob & Teddy		
Gather Bridge Details		100%	9/18/23	9/25/23
Contact Bridge Manufacturer		100%	9/18/23	9/25/23
Gather Abutment Details		100%	10/9/23	10/16/23
Abutment Design		100%	10/30/23	11/17/23
Cost Estimation		Jordan		
Find Detail Prices		100%	10/30/23	11/17/23
Separate Prices into Categories		100%	11/6/23	11/17/23
Gather Material Volumes		100%	11/6/23	11/17/23
Finalize Costs		100%	11/6/23	12/8/23
Deliverables Preparation and Revisions		Team		
Drawing Sets		100%	10/23/23	12/8/23
Reports		100%	10/30/23	12/8/23
Presentation Slides		100%	11/6/23	11/17/23
Poster		100%	11/6/23	12/8/23
Revisions		75%	11/6/23	12/8/23

Table 1. Work Plan and Progress

Section IV: Constraints, Challenges, and Impacts

1. Constraints

The design of this project has a time constraint starting on August 18, 2023, to be completed by the end of the Fall semester, December 15, 2023. The scope of the project was discussed in the work plan (see Section 3.2) and each task was assigned and delegated to each team member to meet this constraint.

In both locations, the trail extensions are required to stay within the railroad right of way on the West Site and East Site.

2. Challenges

A few challenges this project presents were the long commute to view the site and surrounding area, making frequent visits difficult. Communication between the client and our team made this easier and helped us make decisions. The team tried to provide options that would allow for multiple case scenarios.

At the West Site, a challenge presented by the initial site assessment was a drainage structure that is in the path of the proposed trail. Another at the West Site is the determination of how many parking spaces will be adequate for accommodating trailhead parking. The number of truck parking spaces needed was unknown, creating the challenge of optimizing the space while providing adequate spaces for food trucks.

Because the city does not own the property, there are unknown challenges as to what future businesses or recreation services will be provided on the given and adjacent properties. In this instance, the plaza location has an existing business that will be designed around without knowledge of potential changes to the building. Adequate number of parking spaces for the plaza and future businesses is currently difficult to estimate.

The bridge removal at the East Site will require consistency with regulations and with regards to safety and protection of wetlands in adjacent locations.

3. Societal Impact within the Community

The enhancements to the Bondurant Trail system will help bring in people from the surrounding communities. The connections added through this project will help match Bondurant's growth over the past two decades. Adding the trail route with the arboretum through the West Site area will help bring people through the city. This will positively impact the city, giving people a chance to get outside and socialize. The new trails will also encourage people to live a healthy lifestyle by walking or biking.

While the social impacts of this project will mostly benefit the community, there is one aspect of it that will not have a positive impact. The creation of the West Site trail is part of a long-term plan to reutilize the downtown area, eventually leading to the removal of the old silos that remain there. While they are not currently being used, residents who have been around Bondurant for multiple decades have expressed concerns about losing the skyline they provide. The grain bins are part of the city's history and provide a landmark in the heart of Bondurant, so the start of this project could cause some discourse due to the overall change that would follow. That said, the trail expansion project will have a mostly positive social and economic impact.

Section V: Alternative Solutions That Were Considered

Bike Trail Design Options:

1. Trail Material
 - a. PCC
 - i. High durability and strength, longer-life span, and little maintenance. Disadvantages can include higher costs and potential cracking.
 - b. Asphalt
 - i. Lower costs, easier construction, and long-life span (if maintained). Disadvantages can include high maintenance and lower visual appearance.
2. Trail Width
 - a. 8' Wide
 - i. Lower costs due to less material. Disadvantages can include tight windows for pedestrian crossing/passing and maintenance with vehicle.
 - b. 10' Wide
 - i. Accommodates two-way traffic, large maintenance vehicles, and operating space at high speeds. Disadvantages can include higher costs due to additional material.
3. Trail Layout
 - a. Potential Layout
 - i. Trail Layout is subject to change based on grade changes and property ownership.

Bridge Design Options:

1. Structure Type
 - a. Box Culvert
 - i. Typically, less expensive, less time to design, premanufactured, and easier to construct than a bridge. Disadvantages can include not being able to span the length of the creek, could reduce creek flow, and less appealing visually.
 - b. Pedestrian Bridge
 - i. Typically, more appealing visually, premanufactured, and can span the entire length of the creek. Disadvantages can include higher costs and longer design time.
2. Bridge Appearance
 - a. Decorative Railing
 - i. It is more appealing visually and safety for pedestrians. Disadvantages can include higher costs and maintenance to retain visual appeal.
 - b. Standard Railing
 - i. Lower costs, little maintenance, and safety for pedestrians. Disadvantages can include lower visual appearance.

Parking Lots and Plaza Materials:

1. Permeable Paver System
 - a. Typically, more expensive than a traditional PCC concrete, but can reduce peak flows more effectively from infiltration and the natural water cycle. It also has benefits of groundwater recharge and it visually appealing.
2. PCC Concrete
 - a. A less expensive route when comparing to permeable pavers and is more durable for a longer design life. Traditional storm runoff will occur with this form of parking lot or plaza.

Arboretum Design Options:

1. Ornamental Trees
 - a. Prairie crabapples: vibrant pink color, spacing of 10 to 20 feet from edge of trail, larger spacing prevents apples from falling onto the trail, average full-grown spread of 12 to 20 feet.
 - b. Eastern redbud: have vibrant red color, designed to be planted 10 to 20 feet off the edge of the trail, average full-grown spread of 12 to 20 feet.
2. Overstory Trees
 - a. Shagbark hickory: Greenish-yellow color, spacing of 20 to 30 feet from edge of trail, larger spacing prevents trees intertwining, average full-grown spread of 50 to 70 feet.
 - b. Sycamores: Light green and yellow/brown in the fall, spacing of 20 to 30 feet from edge of trail, branches could intertwine to adjacent trees, average full-grown spread of 50 to 75 feet.
 - c. Black oaks: Light green and yellow/brown in the fall, spacing of 20 to 30 feet from edge of trail, acorns will be dropped, provides less coverage, average full-grown spread of 40 to 60 feet.
 - d. White oaks: Bright to dark green, and copper and burgundy red colors in the fall, spacing of 20 to 30 feet from edge of trail, acorns will be dropped, average full-grown spread of 50 to 80 feet.
3. Arrangement Pattern
 - a. Repeating pattern of one ornamental tree followed by one overstory tree, gives a tunnel of overstory trees, adds variety with the ornamental trees.
 - b. Repeating pattern of two ornamental trees followed by one overstory tree, provides open spacing along the trail, the overstory trees providing tunnel to trail.

Section VI Final Design Details

1. Pedestrian Trail

The design aligned the trail within the former railroad corridors on both sites. The existing trails were “out of the way” or “inconvenient,” to simplify the Chichaqua Valley Trail, we used the existing railroad corridors and tried to match the existing grades as much as possible. Iowa DOT, SUDAS, and AASHTO standards were all used to design for the 10’ wide, 6” thick, 30 mph design speed bike trail (see Figure 5).

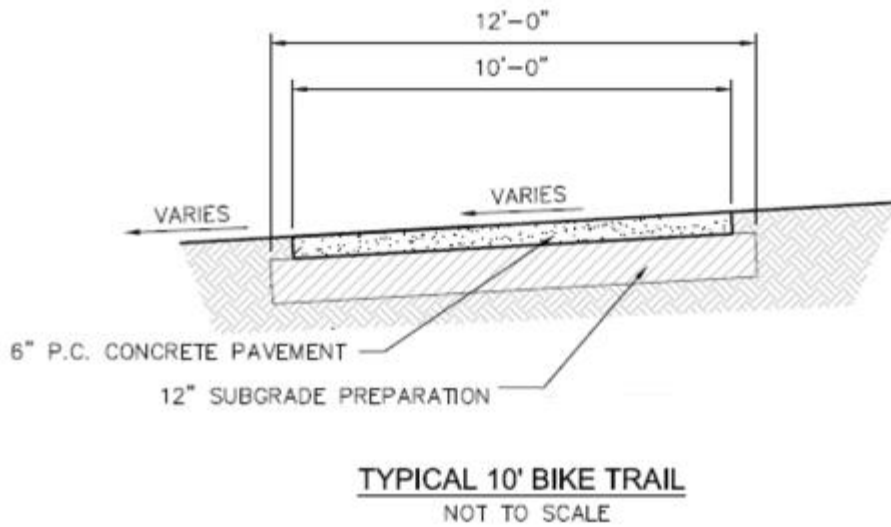

Figure 5. Typical Trail Cross Section

The East Site and its connection east of Highway 65, was a simple connection, bringing together two paths of the trail. The objective was to create a feasible and easy to construct trail while maintaining the functionality and aesthetics of the Chichaqua Valley Trail. The other focus of this site was to connect it to a future development site, the “Bondurant Civic Campus.” Providing a reverse curve near the Highway 65 crossing was done to allow a north leg for the existing trail connection and a south leg for the Civic Campus connection all while avoiding the wetlands to the north of the site.

Construction Quantities			
East Site Trail			
NO.	DESCRIPTION	UNIT	QUANTITY
1	REMOVE BIKE TRAIL PAVEMENT	SY	490
2	6" BIKE TRAIL PAVEMENT	SY	3565
3	12" BIKE TRAIL SUBGRADE PREP	SY	4015
4	BIKE TRAIL SIGNAGE	EA	14

Table 2. East Site Trail Construction Quantities

The West Site was more complex in an area that is relatively flat and has a major drainage way to design around. The existing drainage ditch was the focus of this area with a goal of maintaining the functionality and using it as the drainage outlet for much of the surrounding site. This outlet determined the vertical alignment of the trail and the streets near it to be able

to convey the water from the site. The horizontal alignment for this trail starts at the existing trailhead and continues in a straight line until it reaches the future intersection of Truman Dr and 2nd St. NE. The trail crosses two proposed streets, each with ADA ramps for a smooth transition for pedestrians and bikers. On each side of the trail lies a ditch to convey water to the appropriate drainage structure or outlet to ultimately leave the site. These ditches run the entire length of the trail until it reaches the parking lots on the west of the site.

Construction Quantities			
West Site Trail			
NO.	DESCRIPTION	UNIT	QUANTITY
1	REMOVE BIKE TRAIL PAVEMENT	SY	100
2	6" BIKE TRAIL PAVEMENT	SY	2232
3	12" BIKE TRAIL SUBGRADE PREP	SY	2515
4	BIKE RACKS	EA	3
5	BIKE TRAIL SIGNAGE	EA	10

Table 3. West Site Trail Construction Quantities

Refer to Drawing Set C - Sheets C6.1 to C6.12.

2. Trailhead Parking

The trailhead parking located on the East Site included 48 parking stalls with two ADA-compliant parking spaces. The eastern parking lot has 43 parking stalls with two ADA-compliant parking spaces. The parking stalls will be a permeable paver system to treat a five-year storm event. The driving lanes of the parking lots will consist of PCC paving to reduce any failures that have occurred with permeable pavers over the course of time. Iowa Stormwater Management Manual (ISWMM) was used to design the drainage system and permeable paver system for the trailhead parking.

Two rain gardens are included on the western parking lot where dome-shaped storm inlets are in the event of a storm greater than a 10-year event. The stormwater system can drain a 10-year storm event, and events larger than a 10-year event will be conveyed through overland flow routes.

A 4' flume will be used on the eastern parking lot to convey any event of 5-year storm or greater. Sheet flow will be the main function of this parking lot as there is no crown in the center of the lot.

Refer to Drawing Sheets C9.3 and C9.4.

3. Food Truck Parking & Plaza

The food truck park and the plaza were both designed with the constraint of the existing drainage outlet. Other design constraints included the existing building on site that was to be repurposed and layout of the parcel, which is triangular.

This area was difficult to design because of the irregular shape and having to fit “regular” shapes within it, square parking lots, 31’ wide roads, etc. The design moving forward allows for two entrances to the food truck park and the plaza, and two entrances to the parking lot for the existing business. The food truck park will operate with the food trucks parking on the south side of the road (see Figure 6) to allow for two-way traffic to continue to the east-west road. The north-south road will allow for access to the existing building to the south of the site for any future development.



Figure 6. Rendering of Plaza

Iowa DOT, SUDAS, and AASHTO standards were used to make decisions for the 31’ wide, 7” thick roads on site. Iowa Stormwater Management Manual (ISWMM) was used to design the drainage system for the food truck park and the plaza. The east-west road drains into the north-south road where a low point will collect all the water and convey it to the drainage outlet on the site. In the event of a large storm or blockage in the drainage system an overland flow route was designed to the west of the low point to reduce standing water near the plaza. The parking lot and plaza are unique because of the use of permeable pavers. The permeable pavers allow for infiltration of water through the pavers to help reduce runoff by encouraging the natural water cycle. The pavers will be the entire makeup of the plaza and 60% of the parking lots on site where stalls are located. The roads and the main traffic areas of the parking lots will be PCC concrete to avoid any rutting or erosion that could happen to the pavers in high traffic areas.

Refer to drawing sheets C5.1 and C5.4-C5.5.

4. Lincoln Street

The extension of Lincoln St. from Railroad St. to 2nd St. is included in this design. This will cross the proposed trail along the railroad corridor. Iowa DOT, SUDAS, and AASHTO were all standards used to make decisions for the 31' wide, 7" thick Lincoln Street. Lincoln Street was a continuation of the road to the south (Lincoln Street) and leads north where it will connect to the future 2nd Street. This road was designed with a crest because there were no areas optimal for an overland flow route in the event of a large storm. This road will drain north to the future 2nd Street and the remaining will drain south until it hits inlets further south on existing Lincoln Street. This proposed street will allow access to two proposed parking lots on the east and one on the west of Lincoln St. These parking lots, like the one noted above, are comprised 60% of permeable pavers, and the two-way traffic areas will be PCC concrete.

Refer to drawing sheets C5.1 to C5.3

5. Bridge Design

The bridge was chosen to be prefabricated with concrete decking. It will be designed and manufactured by an approved pedestrian bridge fabricator. The decision to have a prefabricated bridge was made because it is less expensive, can be visually altered to meet clients' needs, and will be easier to erect. Furthermore, it is recommended that the decking is concrete because of its strength and durability in comparison to timber. The bridge will need to have the strength to hold live loads induced by emergency or snow removal vehicles and must be designed for a 10,000 lb. two-axle vehicle load. An example of a pedestrian bridge is provided and was given by Bridge Brothers (Figure 7).

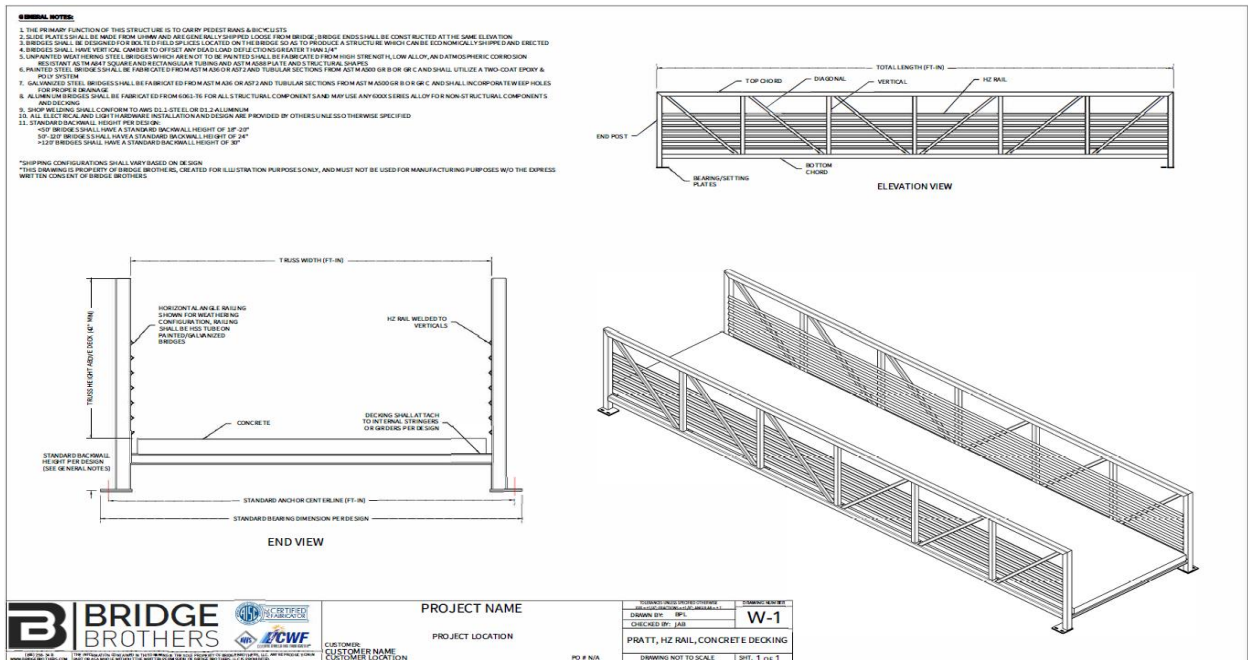

Figure 7. Bridge Brothers Example Design Pratt Truss Bridge

Refer to drawing sheet C2.5.

i. Hydraulic Design

The Santiago Creek drainage area and hydraulic information were determined with StreamStats from the United States Geological Survey (USGS). The upstream drainage area of 2.65 square miles and peak discharges were given. The exceedance probability discharges for the 25, 50, and 100-year flood were determined using StreamStats and are as follows for the bridge location: 546 cfs, 703 cfs, and 869 cfs. The results for the hydrological data and bridge modeling were conducted with HEC-RAS software. The Iowa DNR gives guidance to ensure that the bridge meets requirements for backwater and clearance. The bridge is in a low damage potential area according to the Iowa DNR. It is also with high-risk flooding according to FEMA flood mapping (Appendix E, Figure 13). The Iowa DNR requires that backwater for 100-year flood be less than or equal to 1.5-feet, and that freeboard shall be three-feet or more with 50-year flood. The Iowa DNR will require a permit for this bridge.

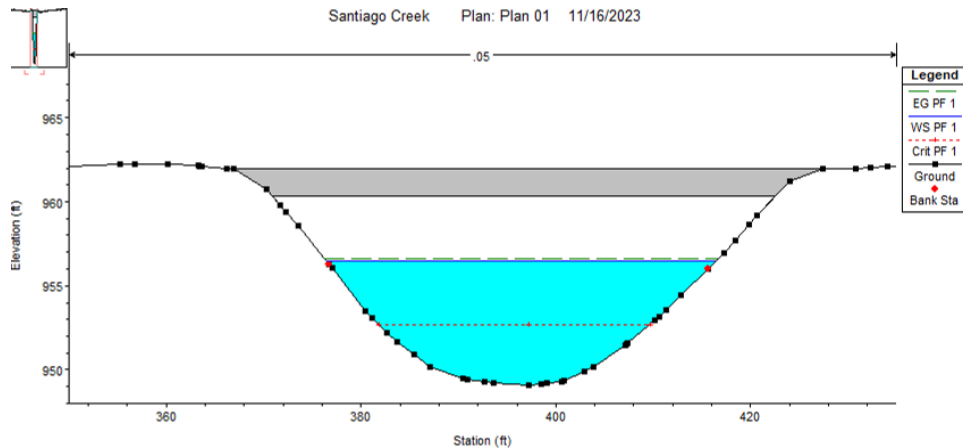

Figure 8. Water Surface Elevation (50-Year Flood)

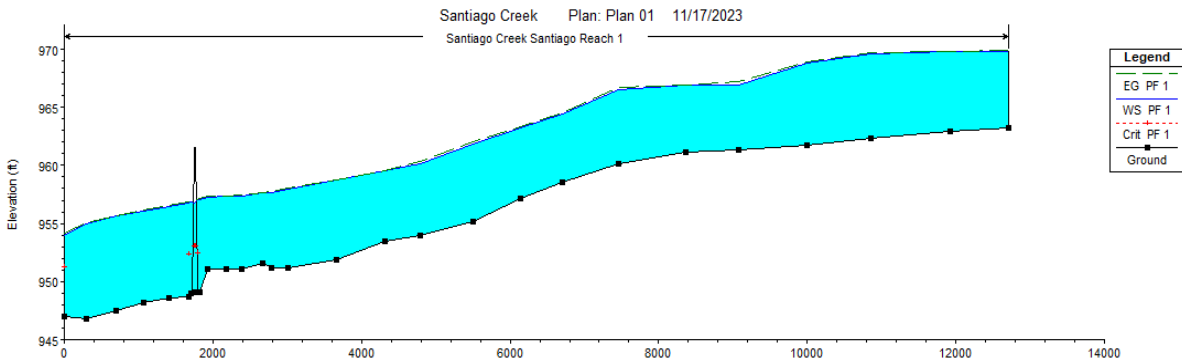

Figure 9. Water Surface Profile with Bridge (100-Year Flood)

The design freeboard for the proposed bridge is 4.86 feet above the 50-year flood, which is more than the required 3 feet above the 50-year flood and will allow ample space for floating debris to pass under the bridge during a flood event. Also, the backwater 150 feet upstream due to the proposed bridge is 6.72 inches, while the maximum value is 1.5 feet at a location 1.5 times the length of the bridge upstream. Backwater calculations were done using the

standard step-method for gradually varied flow and verified with HEC-RAS data (see Figure 8). All data and calculations can be found in appendix E.

ii. Abutments

The abutments were designed as cantilever retaining walls using a dimensional proportion method to compute each element of the abutments. Each element was proportioned based on a determined height of the abutment. The height was figured by taking the distance from the top of the bridge deck to two-feet below the bottom of the channel. The depth of two-feet below the channel was used to allow rip rap to cover the toe of the abutment to the surface profile of the channel. The bottom of the channel was estimated using a constant slope analysis based on geotechnical survey data. Following the determination of the dimensions (Figure 10), three failure mechanisms were tested for: Overturning, uplift, and bearing capacity failure. These calculations can be found in Appendix F. The wingwalls of the abutments were determined by using typical values of the slopes of the characteristics of wingwalls, such as the height from the abutment to the end height of the wingwall, and the angle which the wingwalls would deter from the abutment.

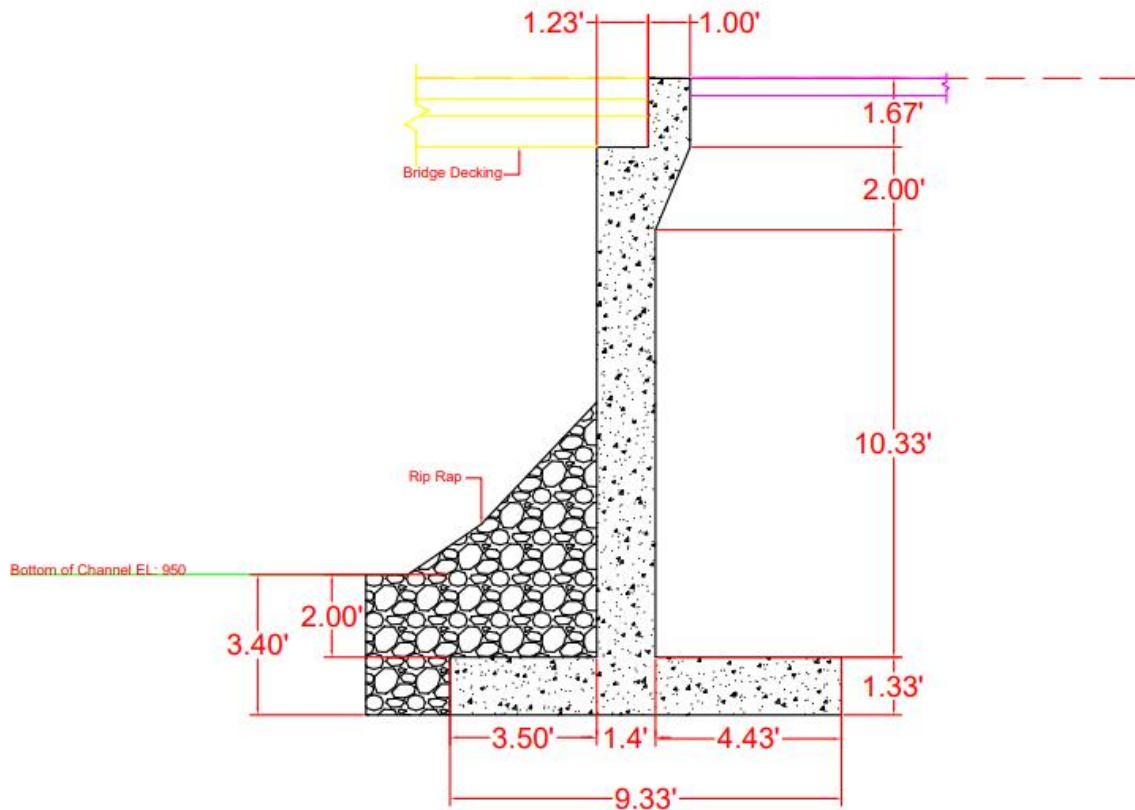

Figure 10. Abutment Dimensions

The design of both the abutments and the wingwalls are subject to change with the completion of on-site geotechnical work. Many of the factors to determine their dimensions were assumed based on typical values. These assumed factors include the bearing capacity of the soil, the channel depth and profile, the unit weight of the soil, and the coefficient of friction.

Refer to drawing sheet C2.4

iii. Riprap Design

Iowa DNR offers stream bank erosion control options based on stream velocity, bank slope and height. To minimize the scour on the abutments, riprap is recommended. Riprap is a layer of various-sized rocks used to protect a streambank from erosion. Using hydrologic data for the Santiago Creek, the references recommended a 1- to 1.5-foot-thick layer of Class E revetment stone which extends 5 feet upstream and downstream from the abutments. Riprap is effective because the rock can adjust to the contours of the stream bank and vegetation can grow among the rocks to provide habitat for wildlife in and above the stream. Riprap is easy to install and repair, has a natural appearance, and does not harm the environment.

Table 2 below provides information that was used to select the streambank erosion control method that is most appropriate for this situation. This table and information come from the Iowa DNR “How to Control Streambank Erosion”.

Method	Description	*Bank erosion problem	Stream velocity	Stream depth	Bank slope	Bank height	Constr. cost	Maint. cost
Riprap	Layer of various-sized rocks used to protect a streambank from erosion.	1, 2, 3, 4	>3 ft/sec	Any	<6:1 & >6:1	<4 ft & >4 ft	High	Low
Jetty system	Dike-like structure from the streambank out into the streambed.	1, 3, 4	>3 ft/sec	Any	<6:1 & >6:1	>4 ft	High	Low
Iowa vanes	Vanes placed in the eroding streambed that cause the flow to be redirected and result in the recollection of sediment on the bank.	1, 4	>3 ft/sec	Any	<6:1 & >6:1	>4 ft	Medium	Low
Vegetated geogrids	Combination of geotextiles, rock fills, and live materials.	1, 3, 4	>3 ft/sec	Any	<6:1	>4 ft	High	Low

*Bank Erosion Problem: 1 = Fast flowing streams with erodible soils 3 = Fill structure for holes in streambank
 2 = Extensive toe- and stream-level erosion 4 = Resistance to occasional heavy flows

Table 2. Streambank Erosion Control Methods

Iowa DNR typically has the following permit conditions for the types of materials used in the project: It should consist of native field stone, quarry run rock, or clean broken concrete. If broken concrete is used, all reinforcement material shall be completely removed from it; if removal is not possible, the reinforcement material should be cut flush with the surface of the concrete. Any reinforcement material must be removed from the materials. The concrete pieces shall be no larger than two feet across the longest flat surface. No asphalt or petroleum-based material shall be used as or included in riprap material.

6. Arboretum

The arboretum was designed to be a tunnel that would start on the west side of the West Site and run east toward the plaza. The tunnel is comprised of both ornamental and overstory trees (Figure 11).



Figure 11. Render of Arboretum

The arboretum consists of two species of ornamental trees and four species of overstory trees, taken from a list of trees developed by the Iowa DNR. The species of ornamental trees selected were prairie crabapples and eastern redbuds, which have vibrant pink and red colors. These trees were designed to be planted 12-feet off the edge of the bike trail to prevent branches reaching over the clear zone. Both trees have an average full-grown spread range of 12-20-feet, so the trees being planted 12-feet off the path will help keep the trail clear of fallen foliage. The overstory trees selected from the Iowa DNR list are shagbark hickory, sycamores, black oaks, and white oaks. All the overstory trees are planted 20-feet off the edge of the bike trail and have an average full-grown spread range of 50-80 feet. The overstory trees are planted 20-feet off the edge of the bike trail to allow the trail to create a tunnel effect, yet not deeply intertwining with the wide spreading range of these trees which could cause disease to spread amongst them. Also planting trees too closely could pose a hazard during storms or windy conditions. The selected ornamental and overstory trees bring an important concept of year-round color; the two species of ornamental trees will provide red and pink color to the trail near the depot in the early springtime, while the overstory trees will bring orange and yellow colors to the trail in the fall.

Refer to Appendix G for proposed arboretum concepts and plan views.

Section VII Engineer's Cost Estimate

The cost estimates are shown below in Table 3. The project cost is separated into two sections, the West Site, and the East Site. The project is broken up this way to allow the project to be bid separately. All the unit prices for this project were taken from the Iowa DOT unit price averages for the pay item.

The West Site cost estimate includes all the pay items for the arboretum, parking lots, Lincoln Street, plaza, and trail implementation from the West Site. The second portion of Table 4 is the East Site cost breakdown of the bridge and the new trail path. The total cost of the project is shown at the bottom of Table 4.

Preliminary Cost Estimate					
WEST SITE					
NO.	DESCRIPTION	UNIT	QUANTITY	UNIT PRICE	TOTAL
1	MOBILIZATION	LS	1	\$ 65,000.00	\$ 65,000.00
2	TRAFFIC CONTROL	LS	1	\$ 15,000.00	\$ 15,000.00
3	EARTHWORK	LS	1	\$ 35,000.00	\$ 35,000.00
4	EROSION CONTROL	LS	1	\$ 10,000.00	\$ 10,000.00
5	CLEARING AND GRUBBING	LS	1	\$ 10,000.00	\$ 10,000.00
6	REMOVE BIKE TRAIL PAVEMENT	SY	100	\$ 15.00	\$ 1,500.00
7	REMOVE PARKING/STREET PAVEMENT	SY	1385	\$ 15.00	\$ 20,775.00
8	7" CONCRETE PAVEMENT W/ 6" CURB	SY	5930	\$ 75.00	\$ 444,750.00
9	12" ROAD SUBGRADE PREP	SY	6675	\$ 6.00	\$ 40,050.00
10	7" PARKING LOT PAVEMENT	SY	1750	\$ 70.00	\$ 122,500.00
11	12" PARKING LOT SUBGRADE PREP	SY	1750	\$ 6.00	\$ 10,500.00
12	PAVEMENT STRIPING	LF	2400	\$ 20.00	\$ 48,000.00
13	PARKING LOT PERMEABLE PAVER SYSTEMS	SY	2500	\$ 140.00	\$ 350,000.00
14	PLAZA PERMEABLE PAVER SYSTEM	SY	900	\$ 140.00	\$ 126,000.00
15	6" BIKE TRAIL PAVEMENT	SY	2232	\$ 65.00	\$ 145,080.00
16	12" BIKE TRAIL SUBGRADE PREP	SY	2515	\$ 6.00	\$ 15,090.00
17	TYPE BA CURB INLET	EA	2	\$ 6,000.00	\$ 12,000.00
18	24" NYLOPLAST DRAIN BASIN	EA	5	\$ 6,000.00	\$ 30,000.00
19	15" FLARED END SECTION	EA	1	\$ 1,900.00	\$ 1,900.00
20	24" FLARED END SECTION	EA	2	\$ 1,900.00	\$ 3,800.00
21	30" FLARED END SECTION	EA	1	\$ 2,600.00	\$ 2,600.00
22	CURB FLUME	EA	3	\$ 1,250.00	\$ 3,750.00
23	15" STORM PIPE	LF	440	\$ 85.00	\$ 37,400.00
24	24" STORM PIPE	LF	220	\$ 120.00	\$ 26,400.00
25	30" STORM PIPE	LF	55	\$ 150.00	\$ 8,250.00
26	TAP EXISTING STORM STRUCTURE	EA	2	\$ 2,000.00	\$ 4,000.00
27	2" ELECTRICAL CONDUIT	LF	1900	\$ 25.00	\$ 47,500.00
28	PICNIC TABLES	EA	18	\$ 2,000.00	\$ 36,000.00
29	BIKE RACKS	EA	3	\$ 3,000.00	\$ 9,000.00
30	ROAD SIGNAGE	EA	14	\$ 3,000.00	\$ 42,000.00
31	BIKE TRAIL SIGNAGE	EA	10	\$ 3,000.00	\$ 30,000.00
32	OVERSTORY TREES	EA	20	\$ 500.00	\$ 10,000.00
33	ORNAMENTAL TREES	EA	20	\$ 500.00	\$ 10,000.00
10% CONTINGENCY (WEST SITE)					\$ 177,400.00
WEST SITE SUBTOTAL					\$ 1,951,000.00

(EAST SITE)					
NO.	DESCRIPTION	UNIT	QUANTITY	UNIT PRICE	TOTAL
1	MOBILIZATION	LS	1	\$ 45,000.00	\$ 45,000.00
2	TRAFFIC CONTROL	LS	1	\$ 6,000.00	\$ 6,000.00
3	EARTHWORK	LS	1	\$ 15,000.00	\$ 15,000.00
4	EROSION CONTROL	LS	1	\$ 7,500.00	\$ 7,500.00
5	CLEARING AND GRUBBING	LS	1	\$ 10,000.00	\$ 10,000.00
6	REMOVE BIKE TRAIL PAVEMENT	SY	490	\$ 15.00	\$ 7,350.00
7	REMOVE EXISTING BRIDGE	LS	1	\$ 30,000.00	\$ 30,000.00
8	REMOVE CONCRETE GRAIN DUMP	LS	1	\$ 5,000.00	\$ 5,000.00
9	6" BIKE TRAIL PAVEMENT	SY	3565	\$ 65.00	\$ 231,725.00
10	12" BIKE TRAIL SUBGRADE PREP	SY	4015	\$ 6.00	\$ 24,090.00
11	24" FLARED END SECTION	EA	2	\$ 1,900.00	\$ 3,800.00
12	24" STORM PIPE	LF	60	\$ 120.00	\$ 7,200.00
13	45' PRE-FAB BRIDGE	LS	1	\$ 340,000.00	\$ 340,000.00
14	BRIDGE ABUTMENTS	EA	2	\$ 10,000.00	\$ 20,000.00
15	RIPRAP	TN	12	\$ 100.00	\$ 1,200.00
16	BIKE TRAIL SIGNAGE	EA	14	\$ 3,000.00	\$ 42,000.00
10% CONTINGENCY (EAST SITE)					\$ 79,600.00
EAST SITE SUBTOTAL					\$ 876,000.00
TOTAL PROJECT COST					\$2,827,000.00

Table 4. West Site and East Site Cost Estimate

Appendix A – Trail Design

Iowa SUDAS Design Manual 2023 Chapter 12 Sidewalk & Bicycle Facilities

Appendix B – Food Truck Park & Plaza Design

Iowa SUDAS Design Manual 2023 Chapter 5 Roadway Design

Iowa SUDAS Design Manual 2023 Chapter 8 Parking Lots

Permeable Interlocking Concrete Pavement, ASCE/T&DI/ICPI 68-18

Iowa SUDAS Design Manual 2023 Chapter 2 Stormwater

Appendix C – Lincoln Street Design

Iowa SUDAS Design Manual 2023 Chapter 5 Roadway Design

Iowa SUDAS Design Manual 2023 Chapter 8 Parking Lots

Permeable Interlocking Concrete Pavement, ASCE/T&DI/ICPI 68-18

Iowa SUDAS Design Manual 2023 Chapter 2 Stormwater

Appendix D – Bridge Design

Iowa DOT LRFD Design Manual

Iowa DNR “How to Control Streambank Erosion”

Appendix E – Hydrology Design

USACE HEC-RAS Hydraulic Reference Manual Modeling Bridges

Iowa DNR Form 542-1023 Flood Plain Management Program

USGS StreamStats <https://www.usgs.gov/streamstats>

StreamStats Report

Region ID:

Workspace ID:

Clicked Point (Latitude, Longitude):

Time:



Basin Characteristics

Parameter Code	Parameter Description	Value	Unit
BASLENAH	Basin length from outlet to basin divide determined using the method in the ArcHydro Toolset	3.06	miles
BFI	Proportion of mean annual flow that is from ground water (base flow)	0.55063	dimensionless
BSHAPE	Basin Shape Factor for Area	3.53	dimensionless
BSLDEM10M	Mean basin slope computed from 10 m DEM	1	percent
CCM	Constant of channel maintenance computed as drainage area divided by total stream length	undefined	square mile per mile
CSL100	Longest flow path slope in feet per miles, using DEM	13.9	feet per mi
CSL10_85	Change in elevation divided by length between points 10 and 85 percent of distance along main channel to basin divide - main channel method not known	4.67	feet per mi
DESMOIN	Area underlain by Des Moines Lobe	100	percent
DRNAREA	Area that drains to a point on a stream	2.65	square miles
DRNFREQ	Number of first order streams per square mile of drainage area	0	1st-order streams per square mile
FOSTREAM	Number of First Order Streams	0	dimensionless
HIGHREG	HIGHREG	1	dimensionless
HYSEP	Median percentage of baseflow to annual streamflow	51.14	percent
I24H10Y	Maximum 24-hour precipitation that occurs on average once in 10 years	4.5	inches
LC11CRPHAY	Percentage of cultivated crops and hay, classes 81 and 82, from NLCD 2011	88.4	percent
LC11DEV	Percentage of developed (urban) land from NLCD 2011 classes 21-24	8.73	percent
LC11IMP	Average percentage of impervious area determined from NLCD 2011 impervious dataset	1.45	percent
PRECIP	Mean Annual Precipitation	34.35	inches
PRJULDEC10	Basin average mean precipitation for July to December from PRISM 1981-2010	3.03	inches
RSD	Relative stream density first defined in SIR 2012_5171	undefined	dimensionless
SSURGOA	Percentage of area of Hydrologic Soil Type A from SSURGO	0	percent
SSURGOB	Percentage of area of Hydrologic Soil Type B from SSURGO	100	percent
SSURGOC	Percentage of area of Hydrologic Soil Type C from SSURGO	0	percent
SSURGOD	Percentage of area of Hydrologic Soil Type D from SSURGO	0	percent
SSURGOKSAT	Saturated hydraulic conductivity in micrometers per second from NRCS SSURGO database	8.6	micrometers per second
STREAM_VAR_G	Streamflow variability index as defined in WRIR 02-4068, computed from regional grid	0.689	dimensionless
STRMTOT	total length of all mapped streams (1:24,000-scale) in the basin	0	miles
TAU_ANN_G	Tau, Average annual base-flow recession time constant as defined in SIR 2008-5065	20.82	days

Figure 12. USGS StreamStats Data

You can choose a new flood map or move the location pin by selecting a different location on the locator map below or by entering a new location in the search field above. It may take a minute or more during peak hours to generate a dynamic FIRMette.

[Go To NFHL Viewer »](#)

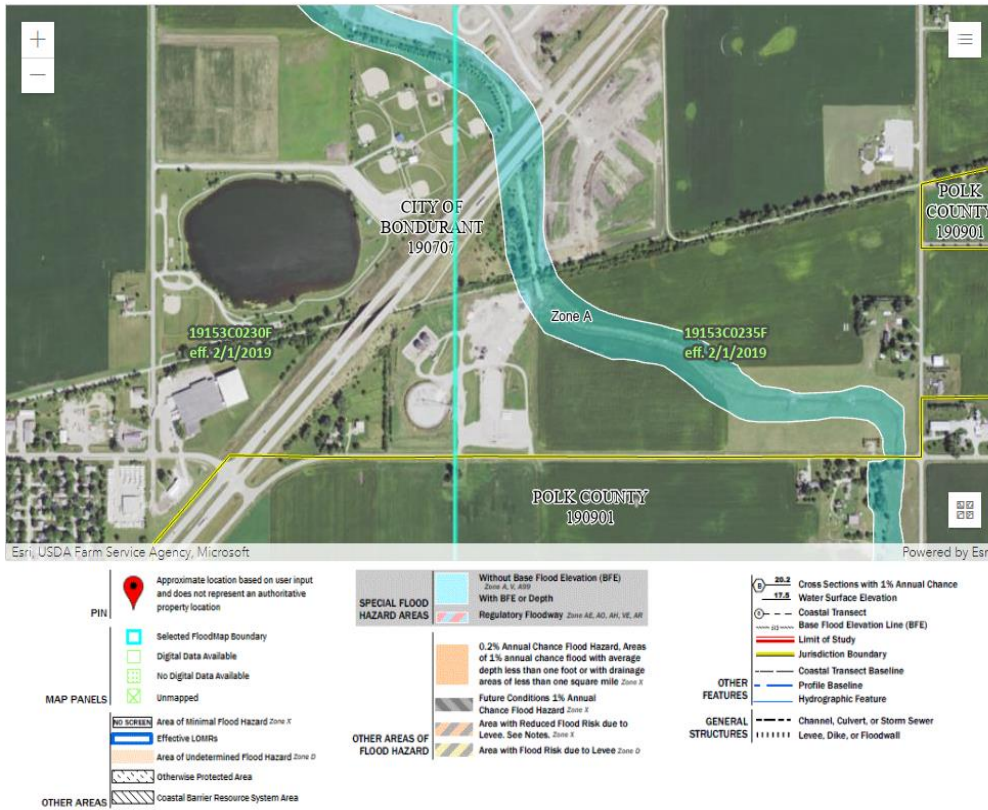

Figure 13. FEMA Flood Map

Table 3.2.2.3. Manning's Roughness Coefficients for natural stream valleys (n-coefficients)

Description	Detailed Description	Manning's Coefficient
Channel, small to medium drainage areas	Irregular section, meandering channel, rocky or rough bottom, medium to heavy growth on bank and side slopes	0.04-0.05
	Uniform section, relatively straight, smooth earthen bottom, medium to light growth on bank and side slopes	0.03-0.04
Channel, large drainage area	---	0.025-0.035
Overbank flood plain, pasture land	No brush or trees	0.05-0.07
	Light brush and trees	0.06-0.08
Overbank flood plain, crop land	---	0.07-0.09
Overbank flood plain, brush and trees	Heavy weeds, scattered brush	0.08-0.10
	Medium to dense brush and trees	0.09-0.12
	Dense brush and trees	0.10-0.15
	Heavy stand of timber, a few downed trees, little undergrowth	0.07-0.10

Table 3.2.2.3. Mannings Roughness Coefficients.

Backwater Calculations

Calculations for Gradually Varied Flow

All Cross Section dimensions obtained from HEC-RAS Profiles and Terrain

Manning's Equation used to determine normal and critical depth
for Trapezoidal Cross Section

Mild Slope $y_n > y > y_c$ M2 Profile

$$y_n := 6.53 \text{ ft} \quad + \quad y_c := 3.27 \text{ ft}$$

The calculations start downstream at Cross Section 1750
at a depth of y_1 and proceed upstream

Known section

Upstream Cross Section 1750

$$y_1 := 3 \text{ ft} \quad A_1 := 114.71 \text{ ft}^2 \quad Q := 708 \frac{\text{ft}^3}{\text{s}} \quad V_1 := 6.17 \frac{\text{ft}}{\text{s}}$$

$$V_{1head} := 0.59 \quad P_{w1} := 39.46 \text{ ft} \quad W_{s1} := 6.4 \text{ ft} \quad W_{s1} := 5.8$$

$$E_1 := 6.39 \text{ ft} \quad S_{f1} := 0.0036 \quad n := 0.05 \quad Z_1 := 2.8 \text{ ft}$$

$$c := 0.3 \quad Z_2 := 3.2 \text{ ft}$$

$$L := 150 \text{ ft}$$

Downstream Cross Section 1600

Initial Trial

First trial

$$y_2 := 3.1 \text{ ft} \quad W_{s2} := 5.9 \quad A_2 := 132.5 \text{ ft}^2$$

$$Q_2 := 703 \frac{\text{ft}^3}{\text{s}} \quad V_2 := 5.3 \frac{\text{ft}}{\text{s}} \quad V_{2head} := 0.437$$

$$P_{w2} := 44.6 \text{ ft} \quad R_{h2} := 2.97 \text{ ft} \quad E_2 := 6.337 \text{ ft}$$

$$S_{f2} := 0.0074$$

$$h_{Lobs} := -0.05466$$

$$s_{fbar} := 0.0055$$

$$h_{Lcalc} := 0.873$$

$$w_{s2calc} := 6.828$$

$$w_{s2update} := 6.36$$

Difference

7.29%

Second Trial

$$y_2 := 3.16 \text{ ft}$$

$$W_{s2} := 6.364$$

$$A_2 := 135.3 \text{ ft}^2$$

$$Q_2 := 703 \frac{\text{ft}^3}{\text{s}}$$

$$V_2 := 5.2 \frac{\text{ft}}{\text{s}}$$

$$V_{2head} := 0.419$$

$$P_{w2} := 44.6 \text{ ft}$$

$$R_{h2} := 3.03 \text{ ft}$$

$$E_2 := 6.783 \text{ ft}$$

$$S_{f2} := 0.007$$

$$h_{Lobs} := 0.392$$

$$s_{fbar} := 0.0053$$

$$h_{Lcalc} := 0.849$$

$$w_{s2calc} := 6.821$$

$$w_{s2update} := 6.59$$

Difference

Not converged

3.46%

Third Trial

$$y_2 := 3.39 \text{ ft}$$

$$W_{s2} := 6.593$$

$$A_2 := 145.1 \text{ ft}^2$$

$$Q_2 := 703 \frac{\text{ft}^3}{\text{s}}$$

$$V_2 := 4.85 \frac{\text{ft}}{\text{s}}$$

$$V_{2\text{head}} := 0.365$$

$$P_{w2} := 44.6 \text{ ft}$$

$$R_{h2} := 3.252 \text{ ft}$$

$$E_2 := 6.96 \text{ ft}$$

$$S_{f2} := 0.0056$$

$$h_{L\text{obs}} := 0.57$$

$$s_{f\text{bar}} := 0.0046$$

$$h_{L\text{calc}} := 0.756$$

$$w_{s2\text{calc}} := 6.78$$

$$w_{s2\text{update}} := 6.68$$

Difference + Not converged

1.42%

Fourth Trial

$$y_2 := 3.49 \text{ ft}$$

$$W_{s2} := 6.69$$

$$A_2 := 149.1 \text{ ft}^2$$

$$Q_2 := 703 \frac{\text{ft}^3}{\text{s}}$$

$$V_2 := 4.71 \frac{\text{ft}}{\text{s}}$$

$$V_{2\text{head}} := 0.345$$

$$P_{w2} := 44.6 \text{ ft}$$

$$R_{h2} := 3.34 \text{ ft}$$

$$E_2 := 7.03 \text{ ft}$$

$$S_{f2} := 0.0051$$

$$h_{L\text{obs}} := 0.641$$

$$s_{f\text{bar}} := 0.0043$$

$$h_{L\text{calc}} := 0.725$$

$$w_{s2\text{calc}} := 6.77$$

$$w_{s2\text{update}} := 6.73$$

Difference Not converged

0.62%

Fifth Trial

$$y_2 := 3.56 \text{ ft}$$

$$W_{s2} := 6.76$$

$$A_2 := 152.3 \text{ ft}^2$$

$$Q_2 := 703 \frac{\text{ft}^3}{\text{s}}$$

$$V_2 := 4.62 \frac{\text{ft}}{\text{s}}$$

$$V_{2head} := 0.331$$

$$P_{w2} := 44.6 \text{ ft}$$

$$R_{h2} := 3.42 \text{ ft}$$

$$E_2 := 7.09 \text{ ft}$$

$$S_{f2} := 0.0047$$

$$h_{Lobs} := 0.702$$

$$s_{fbar} := 0.00417$$

$$h_{Lcalc} := 0.703$$

$$w_{s2calc} := 6.764$$

$$w_{s2update} := 6.764$$

Difference

Converged

0.012%

Backwater Calculation Results

$$\text{Backwater} := y_2 - y_1 = 6.72 \text{ in}$$

Parking #1

**Lesson 20: Permeable Pavement
ISWMM Design Example**

Drainage Basin Information

Drainage Area A : 27807 ft² or 0.638 acres

Impervious Areas

Building : _____ ft²
 Parking Lot : _____ ft²
 Entrance Drive : _____ ft²
 Sidewalk : _____ ft²

DESIGN STORM DEPTHS PER GIVEN INTERVALS AND A 24 HOUR EVENT

Return interval (Years)	Depth (Inches)
1	2.67
2	3.08
5	3.81
10	4.46
100	7.12

TABLE C3-S1-5 FROM TABLE C3-02-3 FOR SECTION 5-CENTRAL, IOWA FOR A 24 HOUR STORM EVENT

Impervious Area A_{imp} : _____ ft² or _____ acres

Percent Impervious I (%): 90% %

Part A: Structural Depth Calculations

Recommended storage aggregate layer thickness: 16 to 18 inches (SUDAS structural guidelines)

Part B: Hydraulic Storage Calculations

Step 1: Compute the required WQ_v treatment volume

$$R_v = 0.05 + 0.009I = 0.05 + 0.009(90) = 0.86$$

$$WQ_v = P \cdot R_v \cdot A = (1.25 \text{ in}) (0.86) (27807) \left(\frac{\text{ft}}{12 \text{ in}}\right) = 2491 \text{ ft}^3$$

Step 2: Compute peak runoff rates

Use TR-55 to compute peak flow rates for WQ_v storm with adjusted CN (IWSMM Chapter 3).
 Use TR-55 to compute peak flow rates for larger storms with standard CNs.

For the WQ_v storm, the adjusted CN is (equation C3-S6-3):

$$CN = \frac{1000}{[10 + 5P + 10Q_a] - 10(Q_a^2 + 1.25Q_a P)^{1/2}}$$

$Q_a = 1.25 \text{ in} (0.86) = 1.075 \text{ in}$ $S = .16$
 $Q_a = P \cdot R_v$ (WQv as a depth) 16.89 $CN = 98.42$ $y = 1\%$
 $L = 230$

With CN and post-development $T_c = 6.2 \text{ min} = 0.10 \text{ h}$, TR-55 $q_{peak} = 3.78 \text{ cfs}$.
 $2.72 \text{ min} = .045 \text{ h}$ f_w WQ_v

**Lesson 20: Permeable Pavement
ISWMM Design Example**

Step 3: Determine storage volume level

Is the pavement system able to manage the water quality volume? Is it able to management larger storms as well?

For this example, the pavement system is used to manage the water quality volume (WQv) and the channel protection volume (Cpv), but larger storms are also considered including the overbank flood protection volume since the site discharges directly to an open channel. Storm inlets are not considered.

Step 4: Verify pavement surface size

Assuming a design infiltration rate f of 10 in/h for the pavement surface, determine the minimum area A_{pp} (ft²) required for the peak flow rate Q (cfs):

$$A_{pp} = \frac{Q}{f} = \frac{Q}{10 \text{ in/h}} \times \frac{3600 \text{ s}}{\text{h}} \times \frac{12 \text{ in}}{\text{ft}} = \frac{3.54 \text{ cfs}}{10 \text{ in/hr}} \cdot \frac{3600 \text{ s}}{\text{h}} \cdot \frac{12 \text{ in}}{\text{ft}} = 15,293 \text{ ft}^2$$

$290 \cdot 18 \cdot 2 = 10440 \text{ ft}^2 \text{ available}$

Step 5: Design storage aggregate depths

The storage aggregate layer must be sized to provide a volume equal to or greater than the volume of runoff generated from the design storm event. Using a porosity n of 0.35 for the storage aggregate and a permeable pavement area A_{pp} , the minimum required depth d (ft) is:

$$d = \frac{WQ_v}{A_{pp} \eta} = \frac{WQ_v}{A_{pp} \cdot 0.35} = \frac{2491}{15293 \cdot 0.35} = 0.465 = 5.58 \text{ in} < 16.18 \text{ in}$$

For a given structural depth d and pavement area A_{pp} , the available storage is:

$$V = dA_{pp} \eta = dA_{pp} \cdot 0.35 = \left(\frac{16.18 \text{ in}}{12} \right) (15293 \text{ ft}^2) (0.35) = 7137 \text{ ft}^3$$

**Lesson 20: Permeable Pavement
ISWMM Design Example**

Step 6: Verify volume of storage

The design storage volume must be equal to or exceed the WQv. Designing for large storms like the Channel Protection Volume (CPv) or the Overbank Flood Protection Volume (Op) may be additional targets.

Unrouted runoff volumes for other design storms can be computed using NRCS methods:

$$S = \frac{1000}{CN} - 10 = \frac{1000}{98.46} - 10 = .162$$

$$I_a = 0.2S = 0.2(.162) = 0.0324$$

$$Q = \frac{(P - I_a)^2}{P - I_a + S} = \frac{(3.08 - 0.0324)^2}{3.08 - 0.0324 + .162} = 2.89 \text{ in}$$

$$V_d = Q \cdot A = \frac{2.89 \text{ in}}{12 \text{ ft}} (27807) = 6697 \text{ ft}^3$$

Approximate routed volume estimates in TR-55 may also be used (see Chapter 8 example).

Step 7: Subdrain system design

6697 < 7137

Where recommend based on soils at the site, include a subdrain. $t_{drain} = 48 \text{ hours}$

Existing soils design infiltration rate = 0.34 in/h < 1 in/h, a subdrain will be required.

For a design volume V and a drainage time t_{drain} , then the subdrain design flow rate Q is:

$$Q = \frac{V}{t_{drain}} = \frac{6697 \text{ ft}^3}{48 \text{ h} \left(\frac{2600 \text{ s}}{\text{h}} \right)} = 0.0959 \text{ cfs}$$

See Chapter 8 example for sizing and place of subdrains.

Part C: Design Alternatives for Larger Storms

For larger storm events, designers must evaluate and provide a system to store or bypass larger storm events. For storm events larger than the 5-year 24-h storm, designers must provide conveyance for stormwater, either through surface flow or traditional stormwater intakes and pipe networks.

Parking #2

**Lesson 20: Permeable Pavement
ISWMM Design Example**

Drainage Basin Information

Drainage Area A : 21438 ft² or 0.492 acres

Impervious Areas

Building : _____ ft²
 Parking Lot : _____ ft²
 Entrance Drive : _____ ft²
 Sidewalk : _____ ft²

DESIGN STORM DEPTHS PER GIVEN INTERVALS AND A 24 HOUR EVENT

Return interval (Years)	Depth (Inches)
1	2.67
2	3.08
5	3.81
10	4.46
100	7.12

TABLE C3-S1-5 FROM TABLE C3-S2-3 FOR SECTION 5-CENTRAL, IOWA FOR A 24 HOUR STORM EVENT

Impervious Area A_{imp} : _____ ft² or _____ acres

Percent Impervious I (%): 90% %

Part A: Structural Depth Calculations

Recommended storage aggregate layer thickness: 16 to 18 inches (SUDAS structural guidelines)

Part B: Hydraulic Storage Calculations

Step 1: Compute the required WQ_v treatment volume

$$R_v = 0.05 + 0.009I = 0.05 + 0.009(90) = 0.86$$

$$WQ_v = P \cdot R_v \cdot A = (1.25 \text{ in}) (0.86) (21438) \left(\frac{\text{ft}}{12 \text{ in}}\right) = 1920 \text{ ft}^3$$

Step 2: Compute peak runoff rates

Use TR-55 to compute peak flow rates for WQ_v storm with adjusted CN (IWSMM Chapter 3).
 Use TR-55 to compute peak flow rates for larger storms with standard CNs.

For the WQ_v storm, the adjusted CN is (equation C3-S6-3):

$$CN = \frac{1000}{[10 + 5P + 10Q_a] - 10(Q_a^2 + 1.25Q_a P)^{1/2}}$$

$Q_a = 1.25 \text{ in} (0.86) = 1.075 \text{ in}$ $S = .16$
 $Q_a = P \cdot R_v$ (WQv as a depth) 16.89 $CN = 98.42$ $y = 2\%$ $L = 230$

With CN and post-development $T_c = 6.2 \text{ min} = 0.10 \text{ h}$, TR-55 $q_{peak} = 3.78 \text{ cfs}$.
 $1.92 \text{ in} = 0.032 \text{ hr}$

**Lesson 20: Permeable Pavement
ISWMM Design Example**

Step 3: Determine storage volume level

Is the pavement system able to manage the water quality volume? Is it able to management larger storms as well?

For this example, the pavement system is used to manage the water quality volume (WQv) and the channel protection volume (Cpv), but larger storms are also considered including the overbank flood protection volume since the site discharges directly to an open channel. Storm inlets are not considered.

Step 4: Verify pavement surface size

Assuming a design infiltration rate f of 10 in/h for the pavement surface, determine the minimum area A_{pp} (ft²) required for the peak flow rate Q (cfs):

$$A_{pp} = \frac{Q}{f} = \frac{Q}{10 \text{ in/h}} \times \frac{3600 \text{ s}}{\text{h}} \times \frac{12 \text{ in}}{\text{ft}} = \frac{2.75 \text{ cfs}}{10 \text{ in/hr}} \cdot \frac{3600 \text{ s}}{\text{h}} \cdot \frac{12 \text{ in}}{\text{ft}} = 11880 \text{ ft}^2$$

$220 \cdot 18 \cdot 2 = 7920 \text{ ft}^2 \text{ available}$

Step 5: Design storage aggregate depths

The storage aggregate layer must be sized to provide a volume equal to or greater than the volume of runoff generated from the design storm event. Using a porosity n of 0.35 for the storage aggregate and a permeable pavement area A_{pp} , the minimum required depth d (ft) is:

$$d = \frac{WQ_v}{A_{pp} \eta} = \frac{WQ_v}{A_{pp} \cdot 0.35} = \frac{1920}{11880 \cdot 0.35} = 0.462 \text{ ft} = 5.54 \text{ in} < 16.18 \text{ in}$$

For a given structural depth d and pavement area A_{pp} , the available storage is:

$$V = dA_{pp} \eta = dA_{pp} \cdot 0.35 = \left(\frac{16.18 \text{ in}}{12} \right) (11880 \text{ ft}^2) (0.35) = 5544 \text{ ft}^3$$

**Lesson 20: Permeable Pavement
ISWMM Design Example**

Step 6: Verify volume of storage

The design storage volume must be equal to or exceed the WQv. Designing for large storms like the Channel Protection Volume (CPv) or the Overbank Flood Protection Volume (Op) may be additional targets.

Unrouted runoff volumes for other design storms can be computed using NRCS methods:

$$S = \frac{1000}{CN} - 10 = \frac{1000}{98.46} - 10 = .162$$

$$I_a = 0.2S = 0.2(.162) = 0.0324$$

$$Q = \frac{(P - I_a)^2}{P - I_a + S} = \frac{(3.08 - 0.0324)^2}{3.08 - 0.0324 + 0.162} = 2.89 \text{ in}$$

$V_d = Q \cdot A = \frac{2.89 \text{ in}}{12 \text{ ft}} (21438) = 5170 \text{ ft}^3$

Approximate routed volume estimates in TR-55 may also be used (see Chapter 8 example).

$5170 < 5544$

Step 7: Subdrain system design

Where recommend based on soils at the site, include a subdrain. $t_{drain} = 48 \text{ hours}$

Existing soils design infiltration rate = 0.34 in/h < 1 in/h, a subdrain will be required.

For a design volume V and a drainage time t_{drain} , then the subdrain design flow rate Q is:

$$Q = \frac{V}{t_{drain}} = \frac{16477 \text{ ft}^3}{48 \left(\frac{2600}{\text{hr}} \right)} = 0.0959 \text{ cfs}$$

See Chapter 8 example for sizing and place of subdrains.

Part C: Design Alternatives for Larger Storms

For larger storm events, designers must evaluate and provide a system to store or bypass larger storm events. For storm events larger than the 5-year 24-h storm, designers must provide conveyance for stormwater, either through surface flow or traditional stormwater intakes and pipe networks.

Parking #3

**Lesson 20: Permeable Pavement
ISWMM Design Example**

Drainage Basin Information

Drainage Area A : 20000 ft² or 0.459 acres

Impervious Areas

Building : _____ ft²
 Parking Lot : _____ ft²
 Entrance Drive : _____ ft²
 Sidewalk : _____ ft²

DESIGN STORM DEPTHS PER GIVEN INTERVALS AND A 24 HOUR EVENT

Return interval (Years)	Depth (Inches)
1	2.67
2	3.08
5	3.81
10	4.46
100	7.12

TABLE C3-S1-5 FROM TABLE C3-02-3 FOR SECTION 5-CENTRAL, IOWA FOR A 24 HOUR STORM EVENT

Impervious Area A_{imp} : _____ ft² or _____ acres

Percent Impervious I (%): 75% %

Part A: Structural Depth Calculations

Recommended storage aggregate layer thickness: 16 to 18 inches (SUDAS structural guidelines)

Part B: Hydraulic Storage Calculations

Step 1: Compute the required WQ_v treatment volume

$$R_v = 0.05 + 0.009I = 0.05 + 0.009(75) = 0.725$$

$$WQ_v = P \cdot R_v \cdot A = (1.25 \text{ in}) (0.725) (20000) \left(\frac{\text{ft}}{12 \text{ in}}\right) = 1510 \text{ ft}^3$$

Step 2: Compute peak runoff rates

Use TR-55 to compute peak flow rates for WQ_v storm with adjusted CN (IWSMM Chapter 3).
 Use TR-55 to compute peak flow rates for larger storms with standard CNs.

For the WQ_v storm, the adjusted CN is (equation C3-S6-3):

$$CN = \frac{1000}{[10 + 5P + 10Q_a] - 10(Q_a^2 + 1.25Q_a P)^{1/2}}$$

$P = 1.25 \text{ in}$
 $Q_a = 1.25 \text{ in} (0.725) = 0.90625 \text{ in}$ $S = .35$
 $Q_a = P \cdot R_v$ (WQv as a depth) 14.96 $CN = 96.62$ $Y = 0.75\%$
 $L = 100$

With CN and post-development $T_c = 6.2 \text{ min} = 0.10 \text{ h}$, TR-55 $q_{peak} = 3.78 \text{ cfs}$.
 $1.79 \text{ min} = .03 \text{ h}$

**Lesson 20: Permeable Pavement
ISWMM Design Example**

Step 3: Determine storage volume level

Is the pavement system able to manage the water quality volume? Is it able to management larger storms as well?

For this example, the pavement system is used to manage the water quality volume (WQv) and the channel protection volume (Cpv), but larger storms are also considered including the overbank flood protection volume since the site discharges directly to an open channel. Storm inlets are not considered.

Step 4: Verify pavement surface size

Assuming a design infiltration rate f of 10 in/h for the pavement surface, determine the minimum area A_{pp} (ft²) required for the peak flow rate Q (cfs):

$$A_{pp} = \frac{Q}{f} = \frac{Q}{10 \text{ in/h}} \times \frac{3600 \text{ s}}{\text{h}} \times \frac{12 \text{ in}}{\text{ft}} = \frac{2.55 \text{ cfs}}{10 \text{ in/hr}} \cdot \frac{3600 \text{ s}}{\text{h}} \cdot \frac{12 \text{ in}}{\text{ft}} = 11016 \text{ ft}^2$$

$150 \cdot 18 \cdot 2 = 5400 \text{ ft}^2 \text{ available}$

Step 5: Design storage aggregate depths

The storage aggregate layer must be sized to provide a volume equal to or greater than the volume of runoff generated from the design storm event. Using a porosity n of 0.35 for the storage aggregate and a permeable pavement area A_{pp} , the minimum required depth d (ft) is:

$$d = \frac{WQ_v}{A_{pp} \eta} = \frac{WQ_v}{A_{pp} \cdot 0.35} = \frac{1510 \text{ ft}^3}{11016 \cdot 0.35} = 0.392 \text{ ft} = 4.7 \text{ in} < 16.18 \text{ in}$$

For a given structural depth d and pavement area A_{pp} , the available storage is:

$$V = dA_{pp} \eta = dA_{pp} \cdot 0.35 = \left(\frac{16.18 \text{ in}}{12} \right) (20000 \text{ ft}^2) (0.35) = 9333 \text{ ft}^3$$

**Lesson 20: Permeable Pavement
ISWMM Design Example**

Step 6: Verify volume of storage

The design storage volume must be equal to or exceed the WQv. Designing for large storms like the Channel Protection Volume (CPv) or the Overbank Flood Protection Volume (Op) may be additional targets.

Unrouted runoff volumes for other design storms can be computed using NRCS methods:

$$S = \frac{1000}{CN} - 10 = \frac{1000}{96.6} - 10 = 0.352$$

$$I_a = 0.2S = 0.2(0.352) = 0.07$$

$$Q = \frac{(P - I_a)^2}{P - I_a + S} = \frac{(3.08 - 0.07)^2}{3.08 - 0.07 + 0.352} = 2.69 \text{ in}$$

$$V_d = Q \cdot A = \frac{2.69 \text{ in}}{12 \text{ ft}} (20000) = 4491 \text{ ft}^3$$

Approximate routed volume estimates in TR-55 may also be used (see Chapter 8 example).

Step 7: Subdrain system design

4491 < 9323

Where recommend based on soils at the site, include a subdrain. $t_{drain} = 48 \text{ hours}$

Existing soils design infiltration rate = 0.34 in/h < 1 in/h, a subdrain will be required.

For a design volume V and a drainage time t_{drain} , then the subdrain design flow rate Q is:

$$Q = \frac{V}{t_{drain}} = \frac{16477 \text{ ft}^3}{48 \left(\frac{2600 \text{ s}}{\text{hr}} \right)} = 0.0959 \text{ cfs}$$

See Chapter 8 example for sizing and place of subdrains.

Part C: Design Alternatives for Larger Storms

For larger storm events, designers must evaluate and provide a system to store or bypass larger storm events. For storm events larger than the 5-year 24-h storm, designers must provide conveyance for stormwater, either through surface flow or traditional stormwater intakes and pipe networks.

total DA for Orange outlet

**Lesson 20: Permeable Pavement
ISWMM Design Example**

Drainage Basin Information

Drainage Area A : 250,000 ft² or 5.74 acres

Impervious Areas

Building : _____ ft²
 Parking Lot : _____ ft²
 Entrance Drive : _____ ft²
 Sidewalk : _____ ft²

Impervious Area A_{imp} : _____ ft² or _____ acres

Percent Impervious I (%): 25% %

Part A: Structural Depth Calculations

Recommended storage aggregate layer thickness: 16 to 18 inches (SUDAS structural guidelines)

Part B: Hydraulic Storage Calculations

Step 1: Compute the required WQ_v treatment volume

$$R_v = 0.05 + 0.009I = 0.05 + 0.009(25) = 0.275$$

$$WQ_v = P \cdot R_v \cdot A = (1.25 \text{ in}) \cdot (0.275) \cdot (250,000) \left(\frac{\text{ft}}{12 \text{ in}}\right) = 7161 \text{ ft}^3$$

Step 2: Compute peak runoff rates

Use TR-55 to compute peak flow rates for WQ_v storm with adjusted CN (IWSMM Chapter 3).
 Use TR-55 to compute peak flow rates for larger storms with standard CNs.

For the WQ_v storm, the adjusted CN is (equation C3-S6-3):

$$CN = \frac{1000}{[10 + 5P + 10Q_a] - 10(Q_a^2 + 1.25Q_aP)^{1/2}}$$

$P = 1.25 \text{ in}$
 $Q_a = 1.25 \text{ in} \cdot (0.275) = 0.344 \text{ in}$ $S = 1.60$
 $Q_a = P \cdot R_v$ (WQv as a depth) 0.09 $CN = 86.2$ $Y = 0.75\%$
 $L = 860$

With CN and post-development $T_c = 6.2 \text{ min} = 0.10 \text{ h}$, TR-55 $q_{peak} = 3.78 \text{ cfs}$.
 $15.85 \text{ min} = 0.264 \text{ hr}$

DA for plaza + roads

**Lesson 20: Permeable Pavement
ISWMM Design Example**

Drainage Basin Information

Drainage Area A : 100,000 ft² or 2.30 acres

Impervious Areas

Building : _____ ft²
 Parking Lot : _____ ft²
 Entrance Drive : _____ ft²
 Sidewalk : _____ ft²

Impervious Area A_{imp} : _____ ft² or _____ acres

Percent Impervious I (%): 45 %

Part A: Structural Depth Calculations

Recommended storage aggregate layer thickness: 16 to 18 inches (SUDAS structural guidelines)

Part B: Hydraulic Storage Calculations

Step 1: Compute the required WQ_v treatment volume

$$R_v = 0.05 + 0.009I = 0.05 + 0.009(45) = .455$$

$$WQ_v = P \cdot R_v \cdot A = (1.25 \text{ in}) (.455) (100,000) \left(\frac{\text{ft}}{12 \text{ in}}\right) = 4740 \text{ ft}^3$$

Step 2: Compute peak runoff rates

Use TR-55 to compute peak flow rates for WQ_v storm with adjusted CN (IWSMM Chapter 3).
 Use TR-55 to compute peak flow rates for larger storms with standard CNs.

For the WQ_v storm, the adjusted CN is (equation C3-S6-3):

$$CN = \frac{1000}{[10 + 5P + 10Q_a] - 10(Q_a^2 + 1.25Q_aP)^{1/2}}$$

$P = 1.25 \text{ in}$
 $Q_a = 1.25 \text{ in} (.455) = .569 \text{ in}$
 $CN = 91.5$
 $S = .93$
 $y = 0.75\%$
 $L = 860$

With CN and post-development $T_c = 6.2 \text{ min} = 0.10 \text{ h}$, TR-55 $q_{peak} = 3.78 \text{ cfs}$.
 $12.86 \text{ in} = .214 \text{ hr}$

parking 1: DA = 27807 ft² ~ 90% imp 10% p.u
 parking 2: DA = 21438 ft² ~ 90% imp 10% p.u
 parking 3: DA = 20000 ft² ~ >5% imp 25% p.u
 total DA for outfall: 250,000 ft² 860 ft = L 4 = 1%
 DA for plaza + roads: 100,000 ft² 860 ft = L 4 = 1%

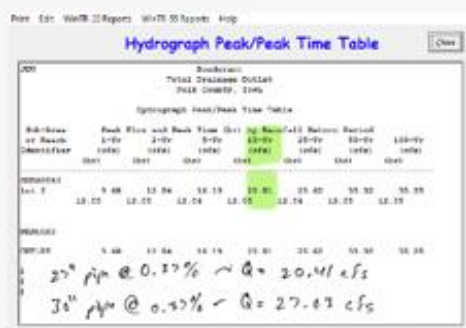
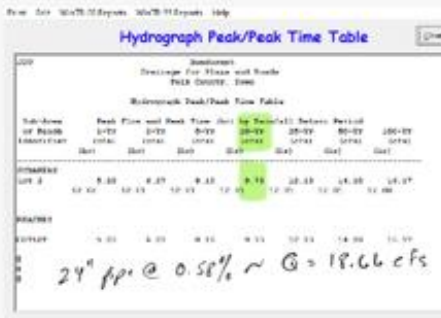
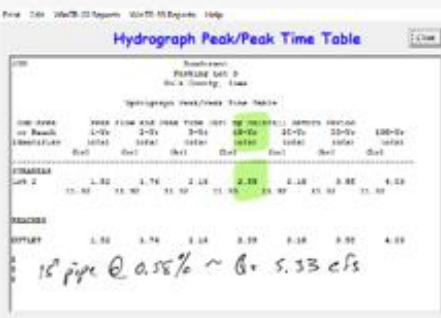
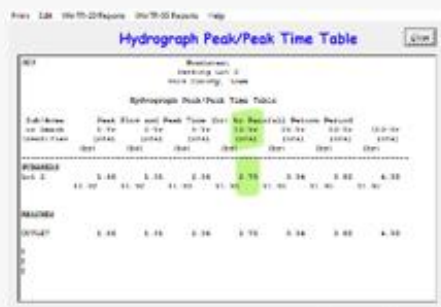
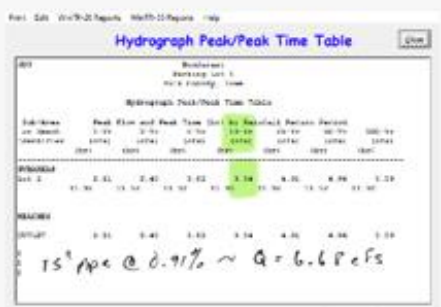

Appendix F – Abutment Design

ABUTMENT DESIGN

PARAMETERS

SOIL PROPERTIES

L507—Canisteo clay loam, Bemis moraine, 0 to 2 percent slopes														
Canisteo, Bemis moraine	85	C/D	0-8	Clay loam, silty clay loam	ML, MH	A-7-5, A-7-6	0-1-4	0-1-2	85-98 100	66-90 90	63-87 98	51-70 81	44-52 -64	17-19-23
			8-16	Clay loam, loam, silt loam, silty clay loam	MH, ML	A-6, A-7-5, A-7-6	0-0-3	0-0-1	87-98 100	72-92 90	66-89 98	50-69 79	37-69 -57	15-20-24
			16-20	Loam, silt loam, silty clay loam, clay loam	CL	A-7-6, A-6, A-7-5	0-0-3	0-0-1	87-98 100	72-92 90	66-89 98	50-69 79	35-65 -54	15-20-24
			20-36	Clay loam, silty clay loam, sandy loam, loam, silt loam	CL	A-6, A-4, A-7-6	0-0-3	0-0-1	88-98 100	73-93 90	60-86 98	42-62 74	25-38 -49	6-15-23
			36-79	Sandy loam, loam	SC, CL-MI, CL	A-6, A-4	0-0-3	0-0-1	89-98 100	75-93 90	64-84 95	39-53 63	19-25 -33	4-8-14

Load Bearing Pressure

$q := 2000 \text{ pcf}$

Coefficient of Friction

$\phi := 30 \text{ deg}$ $\beta := 10 \text{ deg}$

Unit Weight of Soil

$\gamma_d := 93 \text{ pcf}$ **Clay Loam**

$\gamma_r := 90 \text{ pcf}$ **Rip Rap**

The Unit Weight of the Soil, beta, Load bearing Pressure, and the Coefficient of Friction are all assumed based on typical values.

CONCRETE PARAMETERS

$\gamma_c := 155 \text{ pcf}$ $f_y := 75 \text{ ksi}$ $f'_c := 4000 \text{ psi}$

We will be using a high strength concrete

ABUTMENT DIMENSIONS - PROPORTION METHOD

$H := 14 \text{ ft}$ Design Variable

$W_A := 14 \text{ ft}$

Width of Abutment

$L := \frac{2}{3} \cdot H = 9.333 \text{ ft}$

$B := \frac{1}{4} \cdot H = 3.5 \text{ ft}$

$D := 0.1 \cdot H = 1.4 \text{ ft}$

$C := 0.1 \cdot H = 1.4 \text{ ft}$

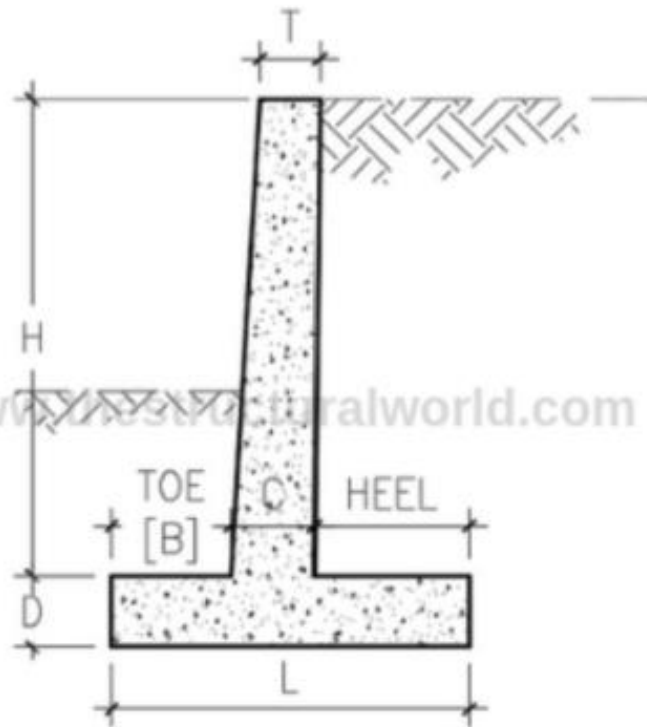

CALCULATIONS

Rankine Earth Pressure Coefficients

$$K_A := \frac{1 - \sin(\phi)}{1 + \sin(\phi)} = 0.333 \quad K_P := \frac{1}{K_A} = 3$$

Surcharge

$$\omega := \gamma_d \cdot H = 1.302 \frac{\text{kip}}{\text{ft}^2}$$

Active Earth Pressures

$$P_A := \frac{1}{2} \cdot \gamma_d \cdot K_A \cdot H^2 = 3.038 \frac{\text{kip}}{\text{ft}} \quad P_H := P_A \cdot \cos(\phi) = 2.631 \frac{\text{kip}}{\text{ft}}$$

$$H_w := 14 \text{ ft} - 1.4 \text{ ft} \quad z_a := \frac{H_w}{3} = 4.2 \text{ ft} \quad P_V := P_A \cdot \sin(\phi) = 1.519 \frac{\text{kip}}{\text{ft}}$$

Passive Earth Pressures

$$H_p := 2 \text{ ft} \quad \text{Top of Footing to Top of Soil}$$

$$P_p := \frac{1}{2} \cdot \gamma_d \cdot K_P \cdot H_p^2 = 0.558 \frac{\text{kip}}{\text{ft}}$$

STABILITY ANALYSIS

WEIGHTS

Weight of Soil

$$W_{s1} := \gamma_d \cdot 3.61 \text{ ft} \cdot 1.67 \text{ ft} = 0.561 \frac{1}{\text{ft}} \cdot \text{kip}$$

$$W_{s2} := \gamma_d \cdot \left(\frac{4.43 \cdot \text{ft} + 3.61 \cdot \text{ft}}{2} \cdot 2 \text{ ft} \right) = 0.748 \frac{1}{\text{ft}} \cdot \text{kip}$$

$$W_{s3} := \gamma_d \cdot 10.33 \text{ ft} \cdot 4.43 \text{ ft} = 4.256 \frac{1}{\text{ft}} \cdot \text{kip}$$

$$W_{s4} := (\gamma_r \cdot 3.5 \text{ ft} \cdot 6.17 \text{ ft}) \cdot \frac{2}{3} = 1.296 \frac{1}{\text{ft}} \cdot \text{kip} \quad \text{Rip Rap}$$

Weight of Concrete

$$W_{c1} := L \cdot D \cdot \gamma_c = 2.025 \frac{1}{ft} \cdot kip$$

$$W_{c2} := D \cdot 12.33 \text{ ft} \cdot \gamma_c = 2.676 \frac{1}{ft} \cdot kip$$

$$W_{c3} := 2 \text{ ft} \cdot 1 \text{ ft} \cdot \frac{1}{2} \cdot \gamma_c = 0.155 \frac{1}{ft} \cdot kip$$

$$W_{c4} := 1 \text{ ft} \cdot 1.67 \text{ ft} \cdot \gamma_c = 0.259 \frac{kip}{ft}$$

Footing

Stem

Connection

Top

Weight From Bridge

Estimated Bridge Reactions *estimates may vary, not to be used as final design

params

Anchor Locations (Qty)	4	
Total Height	6.0 ft	*Estimated
Outside Truss Width	34.7 ft	*Estimated
Bridge Length	45.0 ft	
Coefficient of Expansion (1/F)	6.50E-06	
Design Temperature Range	120	

Estimated Loads

Dead Load (DL)	8962 lb	
Vehicle Load (VL)	20000 lb	
Live Load (LL)	86700 lb	*50psf
Wind Load (WL)	14366 lb	*15.5psf as if enclosed
Overtopping Wind (OW)	13200 lb	*20psf
Seismic (E)	38843 lb	*Based on regional averages

Minimum Expansion Range

6.42 in

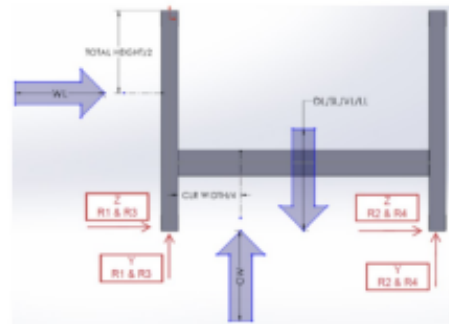

$$w_d := \frac{55062}{45 \cdot 14} \text{ psf} = 87.4 \text{ psf}$$

$$w_l := \frac{56700}{45 \cdot 14} \text{ psf} + \frac{20000}{45 \cdot 14} \text{ psf} = 121.746 \text{ psf}$$

$$w_u := 1.2 \cdot w_d + 1.6 \cdot w_l = 299.674 \text{ psf}$$

$$P_u := w_u \cdot 14 \text{ ft} \cdot 45 \text{ ft} = 188.794 \text{ kip}$$

The Force of the Bridge will be acting as a vertical load downwards at the top of the stem.

Location of Weight (x)

Location of X-bar of soils

$$x_{s1} := B + C + \left(4.43 \text{ ft} - \frac{3.61}{2} \text{ ft}\right) = 7.525 \text{ ft} \quad x_{s2} := B + C + \frac{3.61}{2} \text{ ft} - (4.43 - 3.61) \text{ ft} \cdot \frac{1}{3} = 6.432 \text{ ft}$$

$$x_{s3} := B + C + \frac{1}{2} \cdot 4.43 \text{ ft} = 7.115 \text{ ft}$$

Location of X-bar of Concrete

$$x_{c1} := \frac{1}{2} \cdot (B + C + 4.43 \text{ ft}) = 4.665 \text{ ft} \quad x_{c2} := B + \frac{1}{2} \cdot C = 4.2 \text{ ft}$$

$$x_{c3} := B + C + \frac{1}{3} \cdot 1 \text{ ft} = 5.233 \text{ ft} \quad x_{c4} := B + C + \frac{1}{2} \cdot 1 \text{ ft} = 5.4 \text{ ft}$$

CALCULATIONS

$$\Sigma M_r := W_{c1} \cdot x_{c1} + W_{c2} \cdot x_{c2} + W_{c3} \cdot x_{c3} + W_{c4} \cdot x_{c4} + W_{s1} \cdot x_{s1} + W_{s2} \cdot x_{s2} + W_{s3} \cdot x_{s3} = 62.203 \text{ kip}$$

This is without the weight of the bridge. Calculated to see if the abutment will hold by itself. With the weight of the bridge, it will still exceed the desired FS.

$$\Sigma M_o := P_H \cdot z_a = 11.05 \text{ kip}$$

$$FS_o := \frac{\Sigma M_r}{\Sigma M_o} = 5.629$$

$$\Sigma P := W_{c1} + W_{c2} + W_{c3} + W_{c4} + W_{s1} + W_{s2} + W_{s3} = 10.679 \frac{\text{kip}}{\text{ft}}$$

$$F_{max} := 12.198 \cdot \tan(\phi) \frac{\text{kip}}{\text{ft}} + 9.33 \cdot \frac{(0.5 \cdot 625)}{1000} \frac{\text{kip}}{\text{ft}} = 9.958 \frac{\text{kip}}{\text{ft}}$$

$$FS_v := \frac{F_{max}}{P_H} = 3.785$$

UPLIFT CHECK

$$X_R := \frac{\Sigma M_r - \Sigma M_o}{\Sigma P} = 4.79 \text{ ft}$$

$$e := \frac{L}{2} - X_R = -0.123 \text{ ft} \quad \frac{L}{6} = 1.556 \text{ ft}$$

MAX APPLIED STRESS USING HANSENS EQUATION

$$A := L \cdot D + C \cdot 12.33 \text{ ft} + 1 \text{ ft}^2 + 1 \text{ ft} \cdot 1.67 \text{ ft} = 32.999 \text{ ft}^2$$

$$q_{toc} := \frac{\Sigma P}{L \cdot 1.4} + \frac{\Sigma P \cdot e \cdot \left(\frac{L}{2}\right)}{\left(\frac{1}{12} \cdot 1.4 \cdot L^3\right)} = 752.45 \text{ psf} \quad \|>\| \quad w_u = 299.674 \text{ psf}$$

$$c' := 625 \text{ psf}$$

$$\Sigma \gamma D := \gamma_r \cdot 3.33 \text{ ft} = 299.7 \text{ psf}$$

$$B' := L - 2 \cdot e = 9.58 \text{ ft}$$

$$N_c := 30.1 \quad N_q := 18.4 \quad N_\gamma := 15.1$$

Shape factors = 1, Continuous

$$d_c := 1 + 0.35 \cdot \left(\frac{3.33}{1.4}\right) = 1.833$$

$$d_q := d_c$$

$$d_\gamma := 1$$

$$\frac{F_{max}}{\tan(\phi)} = 17.248 \frac{\text{kip}}{\text{ft}}$$

$$i_q := \left(1 - \left(\frac{14}{17.248}\right)^2\right) = 0.353 \quad i_\gamma := i_q^3 = 0.21 \quad i_c := i_q - \frac{1 - i_q}{N_q - 1} = 0.316$$

$$q'_n := \left(625 \cdot N_c \cdot d_c \cdot i_c + 299.97 \cdot N_q \cdot d_q \cdot i_q + \frac{1}{2} \cdot 90 \cdot 9.58 \cdot N_\gamma \cdot d_\gamma \cdot i_\gamma\right) \text{ psf} = 15824.167 \text{ psf}$$

$$q' := \left(\frac{(10.679 + .90 \cdot 3.33 \cdot 3.5) \frac{\text{kip}}{\text{ft}}}{9.58 \text{ ft}}\right) = 2209.656 \text{ psf}$$

$$FS_q := \frac{q'_n}{q'} = 7.161 \quad \text{Checks out}$$

Appendix G – Arboretum Design

Iowa SUDAS Design Manual 2023 Chapter 10 Street Tree Criteria

Iowa DNR: Trees and Shrubs Native in Iowa

Concept 1

The tunnel is made up of both ornamental and overstory trees starting near the new parking lot at the West Site and will run east. The tunnel will run down in a pattern of 2 ornamental trees then 1 overstory tree until the entry road to the plaza. At that point the tunnel will end where the trail will open near the plaza where over story trees will be planted further 60 feet apart to provide a park like setting near the plaza. This will open the area around the plaza and will provide a good amount of shade for the area. The tunnel will then start up again at the end of the plaza and repeating the same pattern will run on until the end of the trail.



Concept 2

The arboretum is made up of both ornamental and overstory trees starting near the new parking lot at the West Site and will run east. The tunnel will have a repeating pattern of one ornamental tree followed by one overstory tree. The arboretum will continue all the way down until the entrance of the plaza, where the trees stop on the north side of the trail due to the new plaza, while it will continue the south side through the plaza. It will then start again on the north side after the plaza, and they will both run down together repeating the same pattern. The arboretum was designed to provide a strong tunnel-like feel with the large amount of overstory trees, while the ornamental trees provide a break in the tunnel and add variety.



Concept 3

The arboretum is made up of both ornamental and overstory trees starting near the new parking lot at the West Site and will run east. The tunnel will have a repeating pattern of two ornamental trees followed by one overstory tree. The arboretum will continue all the way down until the entrance of the plaza, where the trees stop on the north side of the trail due to the new plaza, while it will continue the south side through the plaza. It will then start again on the north side after the plaza, and they will both run down together repeating the same pattern. The arboretum was designed this way to provide more open spacing along the trail with the two repeating ornamental trees while also giving that tunnel like feeling with the overstory trees.

