

UNIVERSITY OF IOWA
DEPARTMENT OF CIVIL & ENVIRONMENTAL ENGINEERING
Project Design & Management
(CEE: 3084:0001)

Final Design Report

Bridge and Bikeway

Bidder's Organization Name: AZK Engineering
Lead Point of Contact for Proposal - Zach Gerst (Project Manager)

Proposed Cost: \$890,000.00
<i>The proposed cost listed above is for reference purposes only, not evaluation purposes. In the event that the cost noted above does not match the Bidder's detailed cost proposal documents, then the information on the cost proposal documents will take precedence.</i>

- This proposal and the pricing structure contained herein will remain firm for a period of 180 days from the date and time of the bid opening.
- No personnel currently employed by the Department participated, either directly or indirectly, in any activities relating to the preparation of the Bidder's proposal.
- No attempt has been made or will be made by the Bidder to induce any other person or firm to submit or not to submit a proposal.
- The undersigned is authorized to enter into obligations on behalf of the above-named organization.

To the best of my knowledge all information provided in the enclosed proposal, both programmatic and financial, is complete and accurate at the time of submission.

Zachary R Gerst 2/3/2017
Authorized Signature Date

Zachary R. Gerst (AZK Project Manager)
Name and Title (Typed)

Table of Content

<u>Section I:</u>	1
1.1. Executive Summary.....	1
<u>Section II:</u>	2
2.1. Overview of the Organization.....	2
2.2. Organization Location.....	3
2.3. Organization Experience and Qualifications.....	3
2.4. Project Introduction.....	4
2.5. Report Outline.....	6
<u>Section III:</u>	6
3.1. Design Objectives.....	6
3.2. Approaches.....	7
3.3. Constraints.....	8
3.4. Challenges.....	9
3.5. Societal Impacts.....	10
<u>Section IV:</u>	11
4.1. Bridge Superstructure Design Alternatives.....	11
4.2. Bridge Substructure Design Alternatives.....	13
4.3. Bikeway Layout Alternatives.....	15
4.4. Bikeway Design Alternatives.....	17
4.5. Hydrology Considerations.....	18
<u>Section V:</u>	19
5.1. Bridge Design Selection.....	19
5.2. Bikeway Design Selection.....	21
<u>Section VI:</u>	22
6.1. Bridge Superstructure Design Details.....	22
6.2. Bridge Substructure Design Details.....	23
6.3. Bikeway Design Details.....	24

6.3. Hydrology Analysis.....	25
<u>Section VII:</u>	26
7.1. Construction Work Plan.....	26
7.2. Material Estimates.....	27
7.3. Preliminary Cost Estimates.....	28
<u>Section VIII:</u>	29
8.1. Conclusions.....	29
<u>Section IX:</u>	30
9.1. Bibliography.....	30
<u>Section X:</u>	31
10.1. Hydraulic Analysis.....	31
10.2. Design Sheets.....	41
10.3. Permits.....	78
10.4. RFP Report.....	87
10.5. Calculations and Tables.....	97
10.6. Supplementary Information.....	115
10.7. Notes.....	120

Section I Executive Summary

1.1. Executive Summary

The following document is a comprehensive design report submitted by AZK Engineering (a hypothetical engineering firm) for the preliminary design of the Bridge and Bikeway RFP requested by the City of Mason City. The scope of services provided in this project include the design of a bridge and bikeway as well as a hydraulic analysis for the bridge structure. The designed bridge is to replace the existing Willow Creek Bridge on 12th St. near Taft Avenue and will include two rural traffic lanes as well as a 10-foot bike trail and span 71' across the creek. The bikeway will connect two segments of existing bikeway starting at the intersection of 4th St. and Taft Ave and ending at the corner of 12th St. and Harrison Ave, crossing Willow Creek Bridge on the north side. Due to the construction across Willow Creek, a hydraulic analysis has been conducted to ensure no major changes in creek flow. The design and construction for this project has been broken into two sections: the bridge, and the bikeway.

The street that this bridge sits on is a major rural roadway serving commercial and residential traffic leaving Mason City to reach Interstate 35 west of town. Because bridge construction causes closure of the roadway and creates considerable detouring issues for the local businesses, the primary goal for this design project is rapid build construction. This was reflected in the design of components of the bridge, which were modeled after the Missouri DOT Safe and Sound Bridge Project. The majority of bridge components are pre-cast or constructed off site and transported to the site for placement in the final structure.

Designing the bridge from the ground up, the foundation of the bridge is to be constructed using steel pile bents. Nine HP10x42 pile bents are to be driven into the ground at each abutment to a depth of 60 feet. A 3'x3'x42' pre-cast concrete pile cap will be placed over the piles. This cap will have line up with the steel piles for placement. Once the pile cap is placed, quick high strength concrete will be placed in the holes to create a bond between the pile cap and the piles. A 10' pre-cast concrete bearing/retaining wall will be placed on top of each pile cap in two segments, which will support the superstructure of the bridge. This component will be connected to the cap through dowel reinforcement and a concrete mortar layer. Design of the foundation matches the existing bridge cross-section in order to limit the hydraulic impact as detailed in the hydro analysis.

The bridge superstructure is a single span of 71' and matches the alignment of the existing road. Bridge beams are a new concept hybrid composite beam, which utilize material optimization and act similarly to a pre-stressed concrete beam. These 74' beams are formed off site, where a polymer fiber exterior encases a bottom layer of pre-stressed steel strands, concrete compressive arch, and lightweight foam used as a form and filler material. Beams are transported and placed before concrete is added making them extremely light and highly efficient for construction. Nine beams are to be spaced at 4'-4" to accommodate the 40' width of the bridge. Above the bridge, an 8" slab supports two 13' traffic lanes and a 10' bike and pedestrian lane. Barrier rails and approach details follow standard Iowa DOT plans 1028A and 1029A. A 40' approach slab is also included in the design for this bridge. Detailed design plans are attached to the end of this design report.

The bikeway construction is a part of a larger sidewalk construction project started by Mason City in recent years. This bikeway connects two segments of the existing system on the north and west sides of the town. Because of this, design was created to match that of the existing trail system. The entirety of the path will be 10' wide and paved with asphalt. An approach to each intersection where the bike path crosses a roadway will include a 20' concrete paved section with a traction and warning strip similar to those already existing in the city.

The beginning of the bikeway connects with an existing section of trail on Taft Avenue at 4th St. This section follows Taft Avenue north on the east side of the road. The trail is placed far enough away from the existing roadway as not to affect the existing drainage ditch. The bikeway meets and crosses 12th street and continues east along 12th St. towards town. This connects and with the designed bridge listed above to cross Willow Creek. The remainder of the trail follows 12th St. at an offset of 50' until the bikeway reaches Harrison Avenue, where it crosses to the south side of the street to connect with an existing sidewalk system. The total length of the alignment is 1.8 miles.

Standard pedestrian traffic signs facilitate roadway crossings at all intersections for the bikeway. In addition, a pedestrian stop sign and standard Mason City trail system signs are included in design. The entire trail was designed to meet ADA accessibility standards.

Based on the design listed above, preliminary cost estimates and project construction scheduling is listed are also approximated based using Iowa DOT project bidding as a reference. The total cost for construction of the bridge and bikeway is approximately \$890,000.00 with \$700,000.00 coming from the bridge design and \$190,000 from the bikeway design. This includes the removal of the existing bridge, full construction costs for bridge replacement, acquisition of ROW, placement of the bikeway and final grading and landscaping. The following the accelerated construction timeline, the bridge will take approximately seven weeks to construct and the bikeway will take five weeks.

AZK Engineering thanks the City of Mason City for the opportunity to apply for this design project. We look forward to broadening our experience and providing our services to your community both now and in the future. A detailed report and design for the bridge is included in the remainder of this document.

Section II Introduction

2.1. Overview of the Organization

AZK Engineering is comprised of a group of civil engineering students studying at the University of Iowa. The group brings together the collective knowledge and experience of several senior engineering students from the engineering college. The wide variety of experiences and backgrounds that our design group has acquired makes us well qualified for the stated project. Experience includes, but is not limited to structural, transportation, hydraulic and environmental coursework and design projects. Along with provided university course work, each member has work experience through outside consulting

firms, government positions, and university learning programs. A list of the individuals of the design group and their qualifications are provided below. Resumes of each of the individuals are in the Appendix section to this design report.

2.2. Organization Location

AZK Engineering
University of Iowa College of Engineering
3100 Seamans Center
Iowa City, IA 52242
(319)355-5763

Services for the Mason City design project are to be provided from a department within the University of Iowa. All design work except for a preliminary site visit and final project presentation will be completed at the College of Engineering in Iowa City.

2.3. Organization Experience and Qualifications

AZK Engineering is comprised of a group of civil engineering students studying at the University of Iowa. The group brings together the collective knowledge and experience of several senior engineering students from the engineering college. The wide variety of experiences and backgrounds that our design group has acquired makes us well qualified for the stated project. Experience includes, but is not limited to structural, transportation, hydraulic and environmental coursework and design projects. Along with provided university course work, each member has work experience through outside consulting firms, government positions, and university learning programs. A list of the individuals of the design group and their qualifications are provided below. Resumes of each of the individuals are in the Appendix section to this design report:

Adam Kueny: Adam is a senior civil engineering student at the University of Iowa. Adam will be finishing a four-year Bachelor's degree in civil engineering as well as a minor in business administration. Following his graduation, he plans to continue his education and receive a master's degree in structural engineering in the spring of 2018. Adam is the president of the University of Iowa chapter of the ASCE and a captain of the steel bridge design team and has been a part of several structural design projects both in and out of school. Along with his schooling and extracurricular experiences, Adam has been a part of county engineers and an Iowa DOT internship teams. These internships have provided practical experiences as a design and construction engineer. Adam will be acting as a structural and transportation engineer for this design project and will be the primary CAD and technology engineer for the design group.

Keyu Qiu: Keyu is a senior environmental engineering student at the University of Iowa who will be receiving her bachelor's degree in May of 2017. Keyu has had experience on several design teams including transportation, environmental, and energy system design. She is also currently involved in a research project at the Iowa Institute of Hydraulic Research (IIHR) at the University of Iowa where she conducts hydrology research using computer programs such as Matlab, C programming, and excel. Keyu also has previous engineering work experience at Shaoxing Xiangda Equipment Instillation Company. Keyu

will act as a hydraulics and environmental engineer on this project and will be the primary document and presentation coordinator for the group. She will oversee presentation progress, format, and submission.

Zach Gerst: Zach is completing his fourth year as an engineering student at the University of Iowa. He will be completing his bachelor's degree in civil engineering and a minor in business administration this May. Following graduation, he will be continuing his education to receive a master's degree in structures, mechanics and materials in May of 2018. Zach has in school experience on numerous design projects including transportation, bridge, foundation, and concrete design as well as structural design of a pavilion shelter as a part of an eagle project he completed in 2012. Zach has work experience at H.R. Green where he worked as a structural design engineer as well as structural analysis research at the University of Iowa. Zach will serve as a structural and transportation engineer for this design team as well as the project manager. He will be the primary contact and coordinator of work for the design project.

2.4. Project Introduction

The Mason City Bridge and Bikeway was introduced to the AZK design team as a part of the Civil Engineering Senior Capstone design project. As a part of this project, a request was sent out to several communities in Iowa requesting civil engineering preliminary design projects. In response, several communities submitted projects ranging from city waterworks and flood mitigation design to bridge and structure design and analysis. Teams for this design project were selected based on experience and preferences.



Figure 2.4.1: Existing Willow Creek Bridge layout.

The Mason City design project, which is outlined in this design report, is broken up into two major components. The first, a bridge design, involves the replacement of a 71' span bridge that crosses Willow Creek on the northwestern side of Mason City and a hydraulic analysis of the creek being crossed. The existing bridge is a steel girder design that was built in 1950 and was originally owned by Cerro Gordo County. Control of the bridge passed down to Mason City as city limits expanded to include the road and bridge locations.



Figure 4.4.2: Existing Willow Creek Bridge.

When this bridge was originally designed, it was a rural bridge far outside of city limits receiving little traffic. Due to city expansion in the past 20 to 30 years however, the bridge has become a center for commercial and public traffic exiting Mason City on route to Highway 18 and Interstate 35. Because of this increased heavy truck and car traffic as well as its age, the bridge is nearing the end of its useful life and needs replacement. The new bridge is to accommodate this traffic as well as an estimate for future traffic over the bridge as highlighted in the design sheets attached with this design report.

Also included in this design project is the design for a bikeway connecting the northern and western bike trail systems of Mason City. This bike trail is to begin at the intersection of 12th St. and Harrison Ave. where an existing trail system ends, and end on Taft Ave. near 4th St. The path of the bike trail is to cross Willow Creek and is included in the previously mentioned bridge.

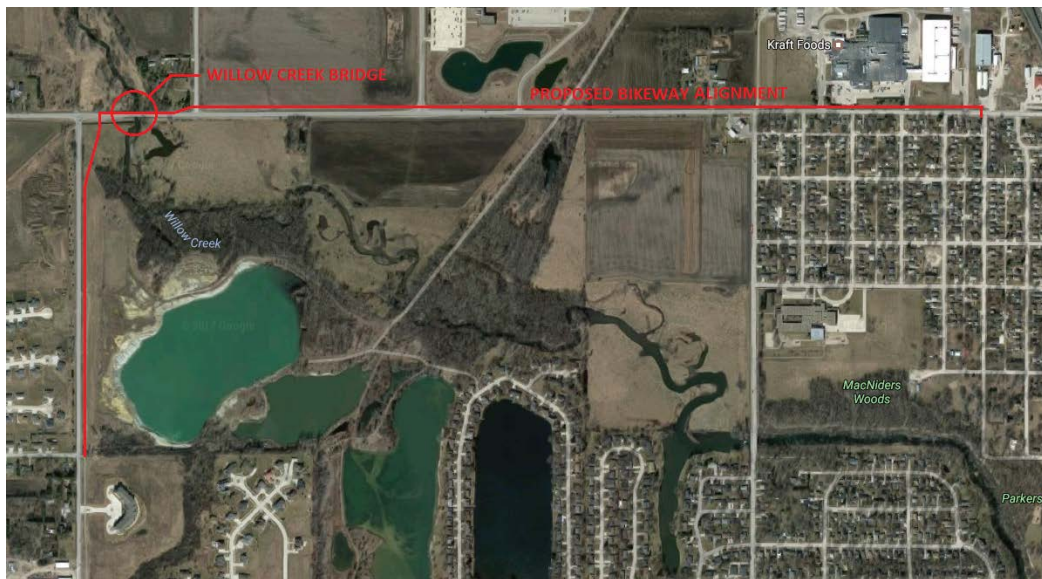

Figure 4.4.3: Bikeway Layout

Mason City has recently expanded its sidewalk and bike trail system creating a full grid of pedestrian travel ways across the city. They hope to further connect these systems, provide additional travel options, and connect Kraft Foods and ASSA ABLOY Wood Doors by sidewalk. The newly designed trail is to match existing system styles, meet ADA requirements, and accommodate maintenance vehicle traffic.



Figure 4.4.4: Sample sign from existing Mason City Bike System

2.5. Report Outline

The following report is a comprehensive summary of all components in the design of the Willow Creek Bridge and bike trail. The report is broken up into ten sections following the basic timeline of the design project. These sections are then further broken up based on the three basic components of the design project; bridge design, bikeway design, and hydraulic analysis.

Sections one, two and three were included in the project proposal, which was submitted to the project selection committee as a design team was selected for this project. The report submitted assessed the initial layout of the project including design objectives, considerations and approaches as well as the fitness of this design team to complete the project. Sections four and five were completed shortly after AZK was approved to continue with the design of this project. In this section, preliminary design alternatives were introduced, detailed and assessed for each component of the project. Sections six through seven detail the final designs for the bridge and bike trail based on design selections in the previous sections. This includes the preliminary designs, construction work plans and cost estimates. All design calculations and summary work is highlighted in the appendix sections nine and ten.

Section III Problem Statement

3.1. Design Objectives

The proposed design project as stated in the provided RFP-05 requests the design of a bike trail extension and multimodal bridge for the City of Mason City, IA. Work tasks include the design of a bikeway along rural roads 12th St. and Taft Ave., which will connect to an existing bike trail system. A 71' span bridge is to be designed to replace the existing bridge,

which spans Willow Creek on 12th St. The new bridge is to accommodate the bikeway and a rural road with heavy industrial traffic. Items required in the design of the bridge and bike trail include but are not limited to:

- Site locations
- Construction boundaries and ROW acquisition
- Existing and future utility locations
- Hydraulic analysis of the stream channel
- Road and bikeway alignments
- Final project grading
- Material lists
- Cost estimates

3.2. Approaches

Outside of the connection between the bikeway and the bridge pedestrian lane, the two components of the project as previously listed are considered completely separate in design and construction. Because of this, the design of each section of the project was done independently with only small consideration to the elevation, connections, preparation between the bridge and bikeway.

The Willow Creek Bridge was designed to meet specific Iowa DOT and AASHTO regulations per state and city code. Because of this, the design of the Mason City heavily involved referencing of the Iowa DOT bridge design manual and specifications. Designs were constructed following recommendations and requirements that made for consistency and ease of construction. Design specifications include dimensions for the bridge components, items to be considered in the design of replacement bridges and requirements that needed to be met in calculations. To ease design and speed up construction the Iowa DOT project library was also used to create standard components including barrier rails and approach slabs.

Several permits and constraints are also required in the construction of the bridge. The major design consideration for the bridge involved the impact that construction would have on the water flow of Willow Creek. In order to prove that no negative impact would be created to the flood plains up or down stream of the bridge, a hydraulic analysis report was created for this project. Other permits included flood plain permits, NPDES permit, Joint Application, Pollution and Prevention Plan, and Traffic Control Plans, which can be found in the appendix to this report.

The bikeway was also designed to follow Iowa DOT, AASHTO, and SUDAS regulations. These three sets of regulations, which are all correlated, were used for the design. The bike trail layout was also based off the existing design of many miles of existing layout in Mason City. The biggest thing that had to be considered for trails was adhering to ADA requirements. Some other things that needed to be considered were the ROW and utilities.

One of the things that had to be researched before the design was completed was the ROW and utilities that are presently owned in the area. The ROW and utilities can be bought or

moved but could lengthen the project. Because of this, the design will need to add great value and considerable benefits to the area. All of these were considered together to create a bikeway to extend the trail system but also try to minimize the cost

3.3. Constraints

The design of the Willow Creek Bridge and Bikeway includes several constraints, which have been considered in the creation and selection of design alternatives. Constraints are measured based on the allowable amount of impact that design and construction are given to a certain internal or external factor related to the design. These constraints can include but are not limited to cost, space, time, design requirements, environmental and social impacts. These constraints can play a key role in the final design selections for the project.

Constraints are ordered based on the level of importance that they play in the final design of the project with the hardest constraints that must be fulfilled listed first followed by the softer more easily adjusted constraints towards the end of this section. Per the request of Mason City, several design parameters must be fulfilled in this project design. These requirements are listed in Section 3.1 above. While these would not be considered the hardest constraints, they are preferential to most other design components in this project. The entirety of the design must be based around those considerations listed above.

The harder constraints primarily come from design codes, which need to be met in order for a bridge design to be considered feasible. The Willow Creek Bridge is considered a rural bridge meaning that design follows outlines from the Iowa DOT Bridge Design Manual. This manual does not limit but rather guides the decision making process for the design of all bridge components. The bridge design manual states allowable design dimensions and requirements as well as provides standards for several components of the bridge, which can be utilized in final design. Use of standardized components make for quicker and easier construction. Because approval of bridge construction is based on the design manual, this would be considered a hard constrain that must be met in design.

Similarly, the bikeway design is based on SUDAS standards, Iowa DOT Design Manual, and ADA guidelines. The bikeway must comply with strict regulations to accommodate those with disabilities as well as meet standard sidewalk requirements. These constraints will govern sidewalk; slopes, curb designs and bikeway intersections to meet accessibility standards for all parties. All standards for this design will be evaluated using the SUDAS Design Manual, Iowa DOT Design Manual and ADA standards guide to meet compatibility.

The design of a new bridge across Willow Creek prompts an analysis of the water flow up and downstream of the bridge location to determine the impact of construction on water flow and the environment. Per Iowa DOT and DNR standards, the water level for varying flood stages is not allowed to change more than one to two inches from the existing condition. This hard constraint prevents up and downstream drought and flooding that may change flood zoning and affect the environment along the river. In order to minimize this effect, design will try to match the existing bridge as closely as possible to limit flow

changes along the river. A hydraulic analysis of the river will be conducted to determine anticipated impacts of the project.

Currently, 12th street serves as a major rural roadway out of Mason City. This serves for private vehicles as well as several industries, which send a large volume of truck traffic through Mason City. Construction of the Willow Creek Bridge would greatly affect the routing of these vehicles and will send much more traffic through the heart of Mason City. A goal for this project is to limit closure time of the 12th street Bridge in order to reduce the impact to these companies and the City of Mason City. This constraint influences the bridge design and the bikeway design. Because of this, the bridge design will be based around a rapid build construction concept. Alternatives for consideration will include pre-fabrication of major components of the new bridge. The bikeway alternatives were planned to not affect the 12th street current ROW in many places along the path. This design alternative for the bikeway could only affect 12th St during the bridge construction and not require more time. Construction concepts will also be altered in an effort to reduce construction time. While timing is important, it is not considered vital to this design project, therefore, this would be considered a soft constraint.

Although not mentioned in the RFP put forth by the City of Mason City, cost is another constraint in any design project. In order for this to be considered a viable project, the design of the bridge must not only meet the constraints and requirements previously listed but do so in as economically of a way as possible. Bridge components and ROW acquisition will play the biggest roles in this cost analysis. Optimizing these designs will be a large consideration in the selection of design alternatives.

3.4. Challenges

Even though this project does not allow for a large amount of variance, there are still a few challenges. The first major challenge is that the bridge needs to be built in a timely manner and faster than other projects. This bridge serves as a main route to multiple factories in the City of Mason City. When the bridge is out it will cause congestion on the other city routes to the local freeway. This challenge plays into several of the constraints listed in the previous section. A balance must be found between the city design requirements, construction methods and materials that might reduce project timing, and the cost of the final project. Finding the right balance between these constraints and preferences will be one of the bigger challenges for this project.

Another challenge is that the bridge and bikeway may cause resistance with the purchase of local Right of Way. The current suggestions for the placement of the bikeway travels through several agricultural, industrial and private properties. While a goal for this project will be to minimize the amount of ROW acquisition, purchase of some private property may be inevitable. This accusation of property will take time depending on the willingness of the local landowners.

Lastly, is the bridge impacts on the flood plain, creek, and local environment. The bridge will need to be expanded and depending on the local species, this may cause problems with the environment. Altering the bridge cross section may also create flow issues up and

downstream of the bridge. The construction of piers in the waterway may not be possible. The bridge should be a similar size to the previous bridge to avoid affecting the flood plain and creek width.

3.5. Societal Impacts

Community: Once the project begins operating, it will create a number of jobs for residents of Mason City. Money used for construction can boost household income. In addition, our project is designed to connect the bike trail from Taft and 12th (north side) to Van Buren over path bridge, which is paralleling an existing rural road. It will give community residents one more option of trip mode and links the local businesses along this route. People can do some exercises in this additional outdoor recreation area. Community cohesion will be fostered due to the convenient transportation.

Traffic: A multimodal bridge is required in the project. Construction processes may cause some inconvenience to local residents. People will be unable to use the bridge as usual and will be rerouted when exiting town to the west. In order to complete this project, 12th street will be fully cut off at the bridge, which may require people to reschedule their travel routes of entering and exiting Mason City during construction process. This puts an extra stress on other travel routes and will cause added congestion during the duration of the project.

Environment: The main function of the bridge required in the project is moving traffic. Therefore, industrial traffic will become more frequent after the project is completed. Along with the increasing of traffic flow, noise and air pollution problems will affect the life quality of community residents to some extent. In addition, stream flow will be changed by bridge construction and might influence the diversity of water system. Backwater will be produced by changing the abutment dimension after construction. Also, some countermeasures should be applied for scour protection.

Economy: Generally, economically developed regions have great transportation networks. Mature traffic network is the necessary standard to develop a community. Connecting bike trail and improving bridge will be helpful to the development of those surrounding companies. They can raise working efficiency in material scheduling and conveying in both community and industry. This will encourage community and job growth. This great traffic network will make residents more willing to go other place for shopping, dining, and entertainment activities. Obviously, it can stimulate the consumptions and promote an economic growth. In the short run of construction however, a burden can be placed on the companies that rely on this network. Rerouting supply chains through Mason City will take time and create congestion. It is for this reason that the project must be completed in a timely manner.

General Public: As we know, tax is based on local economic development. The greater transportation network will take greater income and business growth to this location. Moreover, the greater income and business growth will increase local tax. Government revenues will be raise with increased living standards and consumer spending. After construction is complete, government still need to consider bridge safety and maintenance

to maintain the longevity of the bridge. Bridge construction and maintenance will need to be considered in the future planning of this bridge.

Section III Preliminary Development of Alternative Solutions

4.1. Bridge Superstructure Design Alternatives

All alternatives generated for the design of the Willow Creek Bridge were based around the constraints listed in Section 3.3. Because the bridge construction will cause the closure of 12th street, a highly trafficked rural road, all time constraints and most of the cost constraints have been considered in this component of project design. In order to reduce construction time, design alternatives for the bridge structure were modeled after the Missouri DOT's Safe and Sound Bridge Project. This project, which launched in 2008 sought to replace or repair over 800 bridges over the period of 4 years. Over its lifetime, the project averaged a 42-day bridge construction timeline with its shortest project taking only 22 days to complete. The majority of these projects utilized pre-fabricated components and an optimized work schedule. More information about the Safe and Sound Project can be found in the appendix section of this report.

The primary variable component in the bridge superstructure construction is the beam-slab system used. Several alternative designs have been sited in rapid-build construction in both the Missouri and Iowa DOT. The first such system is a *pre-cast concrete slab* as seen in Figure 4.1.1 below. The City of Mason City has experience with this style of bridge as they recently replaced an in town bridge with this system.



Figure 4.1.1: Pre-cast Concrete Slab Bridge Concept

In this system, 4-foot wide concrete panels that span the length of the bridge are designed and cast prior to bridge construction. Due to its makeup, concrete slab bridges are limited to 40-foot or shorter spans meaning that for the Willow Creek Bridge, an additional pier would need to be constructed to support the deck. Pre-stressing of slab members to generate tensile bending strength in concrete members. This system utilizes short span lengths and concrete as a cheaper material to minimize costs in the structure.

A second design alternative utilizing similar methods to that of pre-cast slab bridges is a *pre-stressed concrete beam*. Similar to the previously listed concrete slab bridges, these

beams utilize pre-stressed steel cables to generate tensile strength. Large steel cables are placed under high tension near the bottom face of the beam before concrete is poured around them. Once the concrete is hardened and bonded to the tension cables, the tension is released creating compression in the beams tension face before prior to loading. Once the beams are placed on the bridge, this compression is canceled out by the tension caused due to the load in the bridge.



Figure 4.1.2: Pre-stressed Concrete Bridge Beams Concept

Because beams can be much deeper than deck slabs, the pre-stressed cables can generate higher strength in the beam. This means that pre-stressed concrete beams have a much longer span length meaning no additional piers would be necessary at the bridge mid-span. Concrete slab bridges tend to be limited by their weight however meaning this design is mostly used for short to medium span bridges. Beams are formed by fabricators offsite to limit construction time. Once beams are placed, a concrete deck is poured over the top to create the roadway surface.

Pre-Fabricated Steel Plate Girders are another alternative that is commonly used in bridge construction. This alternative matches the existing Willow Creek Bridge and many others in Mason City. Like pre-stressed beams listed above, plate girders can be fabricated off-site, and shipped for construction. Once placed, deck forms would be placed and a concrete slab would be poured over the steel girders.



Figure 4.1.3: Steel Plate Girder Bridge Concept

Steel plate girders are constructed by welding three steel plates together to form an I-shaped beam. The top and bottom plates provide the bending strength for the bridge while the center plate gives shear support. By varying the depth and thickness of each of these plates, higher strength and longer bridge lengths can be achieved. Due to its higher strength, less material is required than concrete beams making this alternative optimal for lighter, longer bridges. One concern for this style of bridge however is the weather of exposed steel over time, which adds to maintenance costs for the bridge.

In reviewing the Missouri Safe and Sound Bridge Concept, another more recent beam pre-fabricated bridge beam type was found. **Hybrid Composite Beams** or HCBs, are a new design concept that utilizes optimization of materials to increase design strength and reduce material costs. Like pre-stressed concrete beams, HCB's gain strength through pre-tensioned steel chords and compressive concrete. They are constructed with rows of steel reinforcement in the tension face of the beam, an internal concrete arch to optimize material/strength properties, and a fiber reinforced shell to reduce weathering. HCB's are ship hollow and filled with concrete on site, making shipping and placement cheaper and easier. This type of beam is mostly found on the east coast where weathering from seawater is a large factor but was tested in several bridges as a part of Missouri's Safe and Sound Project.

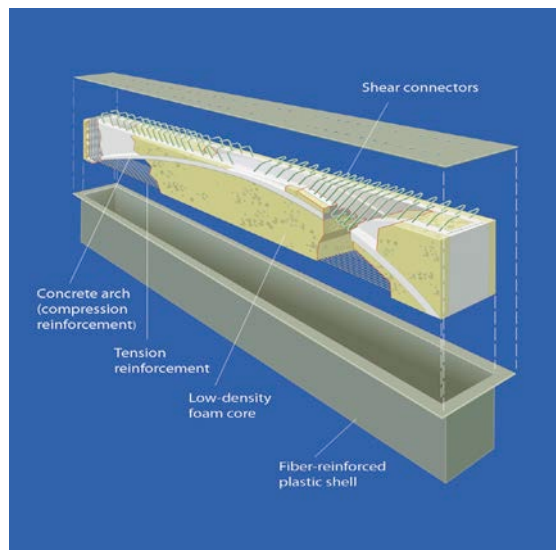

Figure 4.1.4: Hybrid Composite Beam Concept

4.2. Bridge Substructure Design Alternatives

The bridge substructure follows the same rapid build concept as the superstructure. Because the substructure of the bridge must be built before further construction can take place, it is critical that this component of construction be done in a timely manner. Alternatives were selected based on previously approved designs recommended by the Iowa DOT. The two alternatives reviewed for this bridge component include mechanically stabilized abutments and pile bent abutments.

Mechanically Stabilized Abutments and geosynthetically-reinforced soil are constructed by excavating several feet below the road surface at the bridge abutment. Tensile

reinforcement fabric is layered between layers of highly compact soil and tied back away from the abutment wall. Compression from the roadway and soil above the fabric layers holds that fabric in place. Lateral earth pressures caused by the soil attempting to see away from the roadway create tension in the fabric layers, which maintain the form of the abutment. This reduces both horizontal and vertical settlement of soil layers and creates an integral connection between bridge settlement and approach settlement reducing the “bump” that you feel when driving over a bridge. Typical mechanically stabilized abutments can be constructed in as little as three weeks and are generally cheaper than other abutment alternatives.

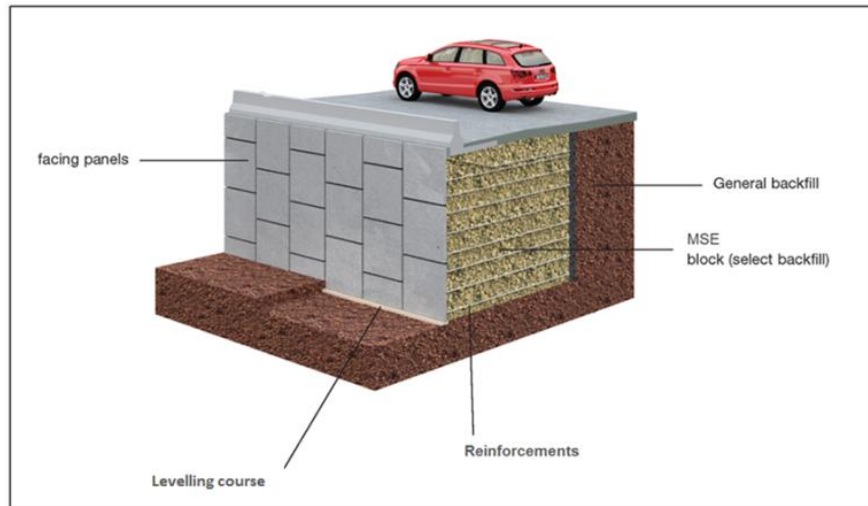

Figure 4.2.1: Mechanically Stabilized Retaining Wall Concept

Pile Bent Abutments are a more standard bridge construction method that has also been sited in rapid build bridge projects. This abutment system would match the current abutment at the Willow Creek Bridge Site. In this method, steel H-piles are driven into the ground at each abutment. The soil friction and point forces from these steel piles create vertical support for the structure above. A large concrete block is placed on top of these driven piles to create a connection between the bridge foundation and the bridge superstructure. Steel piles can be driven relatively quickly and when coupled with pre-cast foundation pile caps can provide a quick solution to the foundation design for a bridge structure.

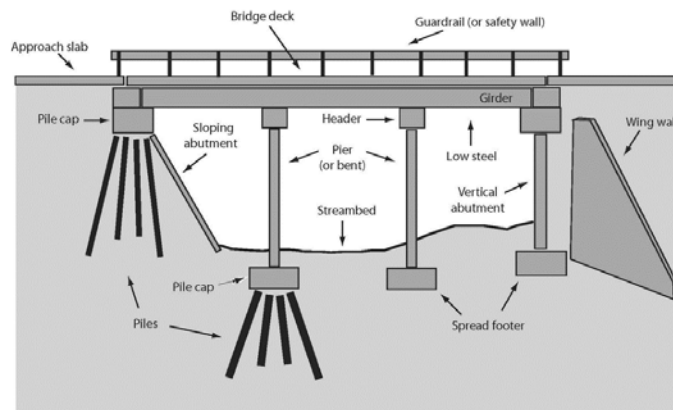

Figure 4.2.2: Pile Bent Abutment Concept

4.3. Bikeway Layout Alternatives

Multiple bikeway layouts were designed that adhered to constraints in Section 3.3. The constraints that involved the designed code had to be used for the layouts. These design codes did not limit the design alternatives considerably because of the flat nature of Mason City and surrounding areas. This allowed for more consideration for the other constraints since the design codes will not have any conflicts for all the designs. Constraints that were looked into further were the build time, cost, and ROW that will be required.

The layouts will be broken into three sections; North Taft Ave., River Crossing, and 12th St. to Mason City. The first section of the layout involves the South section of North Taft Ave. that will connect to the newly placed bike path that ends at 4th St NW. The path from North Taft Ave. to 12th St. will follow the current alignment that runs on N Taft St shown in Figure 4.3.1. The green line is the existing bike path and the white line is the new path.



Figure 4.3.1: Existing path and new alignment

The alternatives in this section start closer to the South section of North Taft and the 12th St alignment. Alternate 1 in red would follow the current trajectory of the path and cross 12th St. Alternate 1 was created because of its simplicity and follows a traditional sidewalk path. Alternate 2 in blue would veer off and cross 12th St to further East of the intersection. The second design was made to bring the bikeway away from the busy intersection and the many utilities in the area.



Figure 4.3.2: Section 1 Layout at road intersection

The second section involves the path across 12th St. to the north of Taft Ave. There were three alternatives for this section. The first alternative in light blue would run along 12th St. and be on the shoulder of the street. This reduces the amount of fill and ROW that would be required for this section. Alternate two is the orange path that runs offset of 12th St. and joins in with the bridge and then veers off after the bridge to connect to N Taft St. This layout will reduce the possible collision with bikers and pedestrians. Lastly, is the alternative three in green, which follows the beginning of the other two alternatives but veer off later down 12th St. This design uses advantages from both of the other alternatives.



Figure 4.3.3: Section 2 crossing Willow Creek

Lastly, is the third segment of the bike path that runs from the North section of N Taft Ave. to N Harrison Ave. There were no alternative layouts made for this section. This path would be to the North of the utilities on 12th St. the entire run of the path shown in Figure 4.3.3 and 4.3.4. Alternatives south of the utilities would require nearly 0.82 miles of culverts to be added in the existing ditches which would be a complete overhaul of the that area. Being north of the utilities requires minimal work with the given layout of the land. When the path enters the city, it will stay on the North Side of the Street. There is currently a grass offset from the road in this area. If the path were moved to the South side many trees and yards would be completely gone. Because of this, the path cross at the last possible point at Harrison Ave where the current path exists.



Figure 4.3.3: Section 3 along 12th St.



Figure 4.3.4: Section 3 entering Mason City

4.4. Bikeway Design Alternatives

The design alternatives were limited because of constraints by the required manuals in Section 3.3 and the current design of the Mason City Bikeways. The alternatives that have to still be considered are the path materials, cross sections, and the merging path along the current pavement.

The path materials will be similar to the current paths around the city which is Asphalt. The depth of the pavement has to be at least 5 inches but could be increased because of use. The crosswalks will be concrete similar to the cities and can have a detectable warning of rubber, cast iron, or formable mold into the concrete. The rubber ones are the easiest to replace to follow ADA standards. The cast iron ones will hold up to natural conditions and plows the best. The detectable warnings into the concrete would require no additional materials.



Figure 4.4.1: Detectable Warnings

The cross sections of the pavements also have a range of how they can be designed. The cross slope for the path itself should have a target of 1.5% and a maximum slope of 2%. The bike path requirements for the pavement width is a minimum of 10ft with a clearance of 2 ft beyond that. The pavement width could be expanded for use. The running slope of the bikeway has to be less than 5% or follow the current slope of the roadway. Lastly, the grade from the ground to the bikeway requires a guardrail after certain slopes to drops are met. The ranges that require a guardrail are shown in Figure 4.4.2.

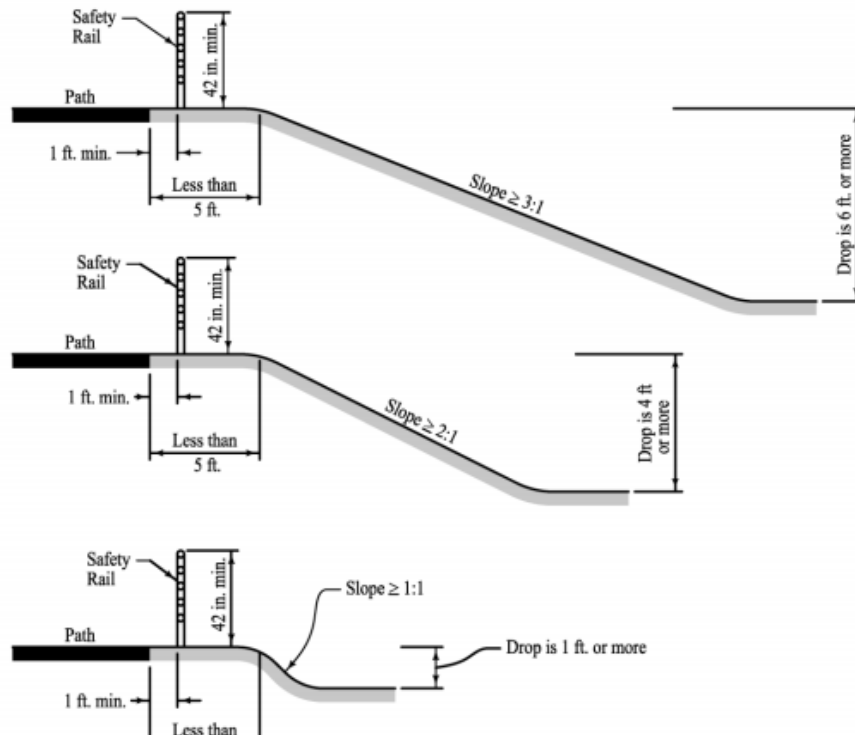

Figure 4.4.2: Guard Rail Protection

Lastly, if the path runs along the street so that it is in the shoulder additional alternatives will have to be made. The first alternative is to have nothing separating the pedestrian and the driver. This would be dangerous but be the cheapest solution. The next design alternative is a rumble strip or curb separating traffic from pedestrians. By having this the driver may become aware of the pedestrians but would not stop a stray vehicle. One more option is a barrier between the person and traffic. The different options for this are a cable barrier, cable rail, or a concrete barrier. All of these provide different resistant depending on the speed of the cars.

4.5. Hydraulic Considerations

The Iowa DOT and DNR require that a hydraulic analysis be conducted whenever new structures cross waterways. The goal of these analyses is to prove that there will be limited environmental and social impacts by project design and construction. As a part of this, the measurements of freeboard, backwater and scour changes needed to be measured between the old bridge and the new one. Freeboard is the measured distance between the top of water flow at flood stage, and the bottom of the bridge. This is a concern when water levels rise so high that they potentially overtop or wash out the bridge. Backwater is a measurement of the flood elevation of water upstream of the bridge. If this measurement changes too drastically, it can have a significant impact on flood zoning and flood damage during heavy rains. Scour impacts the base of the bridge foundations. When fast moving water hits these abutments, hydrodynamic forces can rut out soil sediments and degrade the foundations of the bridge. A comprehensive hydraulic report measuring all of these components can be found in the appendix section of this report.

Section V Selection Process

5.1. Bridge Design Selection

As the bridge is one of the major components to this design project, a lot of consideration needed to go into each aspect of the project, weighing the pros and cons of part of the bridge structure. The primary goals for the design of this bridge were to reduce construction time and meet requirements set forth in the RFP for this project while minimizing costs when possible. In an effort to ease construction, standard designs and components were selected whenever possible for onsite construction to ensure quality and speed of construction.

The bridge cross section governed a major portion of the selection process for this bridge. Before selections could be made, a general layout of the bridge needed to be made to determine the size and quantity of bridge super and substructure components needed for design. Through this process, it was determined that a 40' wide bridge with two 13' lanes and a 10' pedestrian lane would be necessary to meet the RFP requirements. In order to limit the impact of the new bridge on the hydrology of the river, our project team also decided that a single span bridge that could match the existing river cross section would be most appropriate in this design.

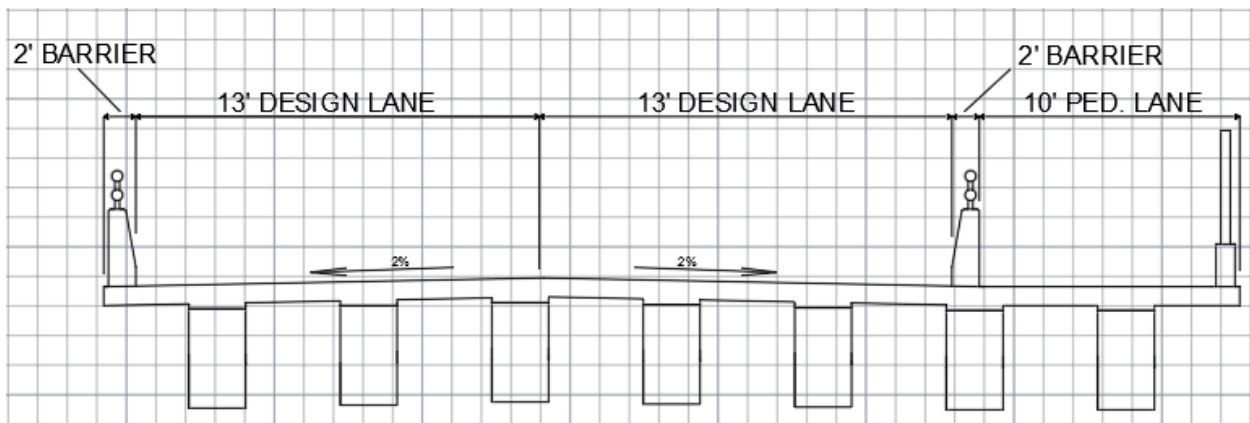

Figure 5.1.1: Design Bridge Cross-Section

Because of the preferred cross section, the pre-cast concrete deck was eliminated from the alternative decision pool. For shorter span bridges such as the Willow Creek Bridge, concrete beams are preferred over steel ones as they have a more efficient cost at these lengths. With the final decision between pre-stressed concrete beams and HCBs, several items were considered.

Pre-cast concrete beams have been in use for much longer than HCB beams and are readily compliant with Iowa DOT standards. The beams utilize cheap materials and optimization of material qualities by design. The design of pre-stressed concrete beams follow a standard set of design plans which can be easily fit to this project and are fabricated in several places throughout the United States. Concrete beams are easily transported and placed onsite and are an ideal solution in rapid bridge construction. Based on preliminary

estimates, the concrete beams for a 71' span bridge would cost around \$80,000 for fabrication, transportation and construction.

Hybrid composite beams act very similar to concrete beams. HCBs utilize material properties of concrete and steel to optimize the cost of construction and beam design. Using basic design optimization theory, HCBs eliminate unnecessary concrete in a beam structure by using low cost, lightweight filler foam to create a compression arch to resist loads of the bridge. Beams are shipped to the site empty and filled with concrete after placement eliminating the need for large equipment in the construction process. The final bridge beams weigh one tenth that of concrete beams.

The lightweight design reduces the cost of shipping, placement and foundation designs for the bridge. This design also reduces the carbon footprint of construction by reducing the amount of concrete necessary in design. Due to the protective fiber polymer shell, these beams are better resistant to weathering and have a design life of over 100 years. Based on data from other HCB projects, the beams for a typical bridge project would cost \$220,000.

After conducting research on the pros and cons of each beam, a report was submitted to the engineering office at Mason City to make the final decision. Mark Rahm and Steve Olney reviewed the reports and decided that they would like to see a design specification for an HCB bridge. Despite the cost differences of the new concept beam, efficient construction and material methods as well as the idea of a new concept bridge favored the hybrid composite beams. Because HCBs are 90% lighter than concrete beams, costs for foundation design could be reduced saving money in other portions of the design. It was decided that the benefits for the HCB beam would outweigh the costs and that the Willow Creek Bridge would be a good location to pioneer the hybrid composite beam in the state of Iowa.

The substructure for the bridge was processed in a similar way. Both of the alternatives listed were assessed based on applicability and benefits. After reviewing each option a second submission was made to Mason City for consideration. Based on their experience in past projects and our understanding of foundations, the pile bent design was selected for the construction of this project. It was decided that this construction method could be done in the timeliest manor by using pre-cast members and was most appropriate for this particular project. Pile bent pile caps work well in conjunction with a retaining wall system, which would need to be designed for the cross-section of this bridge. This system also matches the existing design, limiting the cross-section changes for the river.

Other components for the bridge were selected based on standard plans from the Iowa DOT design manual. Barrier and separation rails match 1028A standard sheets and meet design manual requirements. The pedestrian rail and additional barrier rail details come from standard design sheets 1028SA and 1029C. In order to further speed up construction, it was determined that the wing wall for the bridge would be separate from the retaining wall abutment. This design also follows DOT standards 2110.

5.2. Bikeway Design Selection

After looking at the possible design and layout alternatives, the final bikeway design was selected based on DOT and ADA limitations and in an effort to reduce costs in design of the project. As with the alternative design process, the selections were broken into three sections based on locations of potential routes for the bikeway.

Section 1 of the bikeway will tie in to the existing bike system where it ends at the intersection of 4th St. and Taft Ave. This bike path will continue along the same trajectory as the existing path, running parallel to the road with an offset of 50' feet from the Taft Ave. centerline. The offset was selected keep the bikeway out of the existing ditch in an effort to limit grading and earthwork for the project. The primary selection for this length of the bikeway was the intersection of Taft Ave. and 12th St. For this, it was decided that the bikeway should be offset further from the intersection for two reasons. The first was for the safety of the pedestrians looking to cross 12th St. on the bike path. Because of the nature of the intersection, turning vehicles are focused on approaching traffic on the left and will take less notice to pedestrians. To alleviate this risk, the trail was set further from the intersection giving pedestrians and traffic more time to react to the situation.

Another benefit to this that it will take the construction away from the intersection. If the path runs parallel to the street the storm drain and utilities would have to be moved and redesigned. The storm drain would need to modifications below the street and a T joint would have had to be added where the Taft avenue ditch meets the connecting culvert at 12th St. There also are two to three power lines that would have to be moved in the area. This would require a significant amount of work and a longer construction schedule. The construction of the bikeway can now be done on its own timeline and the work could be done mostly in the ROW instead of the street.

Section 2 represents the extent of the bikeway between the north and south branch of Taft Ave. parallel to 12th St. The bikeway in this section will be immediately adjacent to the roadway starting west of the Willow Creek Bridge. The path will tie into the bridge as shown in the bridge design plans and continue on the road shoulder until Station 34+00.00 where it offsets to 50 feet from the centerline of 12th St. The section that is along the road will have a concrete barrier in between the sidewalk and road for the safety of pedestrians. This was safer and cheaper than other barrier rail options and required significantly less earthwork than a trail offset. This reduces the fill, removal of trees, and the required ROW purchasing while providing an efficient bike path.

Lastly, is section 3 joining the trail on 12th St. from N Taft Ave to Harrison Ave. There weren't many alternatives made for this design because of the lack of constraints. The path is designed to be North of the utilities to keep the current ditch and not require the current utilities to be moved. The path along this section was very flat reducing a small amount of cut and fill. A few things that will be needed on this section that aren't required for the other sections are 20 ft offsets at the driveways. A requirement of bike paths is a 20 ft paved driveway before and after the crossing of the bike path to reduce the gravel on the bike path. There were three driveways that will require this starting after ASSA ABLOY Wood Doors. Once the path enters the city there is currently a narrow region where the

bike path can be placed. The path will be almost adjacent to the road similar to before. There were multiple utilities lines on both sides that will need to be two feet away from the path so there will be a slight weave to the path. If the path was more offset there would be utilities that needed to be removed and the Kraft Foods current fence and parking lot would have to be removed. Even though the path is still very close to the road a concrete barrier rail will not be needed because of the slower traffic of the city and the existing curb which will deter cars from running off the road. This design provides the smallest impact to the area while reducing cost.

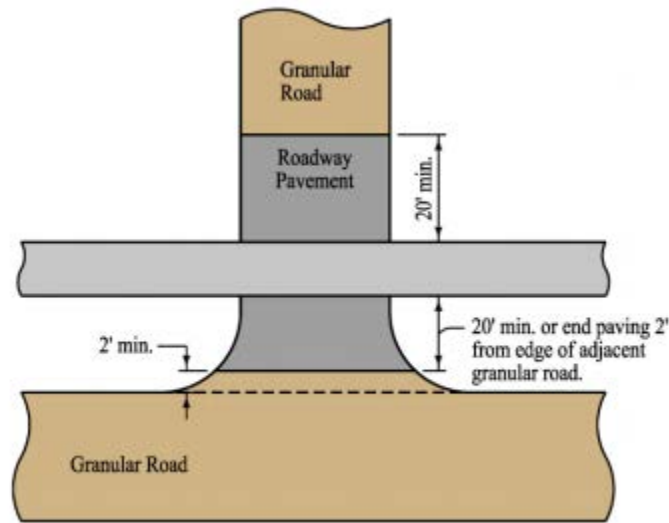

Figure 5.2.1: Crossing at Unpaved Surface

Section VI Final Design Details

6.1. Bridge Superstructure Design Details

The final superstructure design consists of several components that make up the overall structure that spans across Willow Creek. All calculations and design specifications were completed in accordance with the Iowa DOT Design Manual and AASHTO regulations. A summary of the final designs for the bridge superstructure is found in this section while supporting design sheets and calculations are located in the appendix section of this design report.

Based on AASHTO specification [AASHTO-LRFD 9.7.1.1], the concrete deck is 8 inches thick with two layers of transverse and longitudinal rebar reinforcement. The deck will be formed using high performance 4ksi concrete. Loading of the deck is to include the weight of concrete plus a 20 psf integral wearing surface. The concrete deck will be placed as a single cast in place unit spanning the entire length and width of the bridge. As pictured in Figure 5.1.1, the pedestrian walkway will be at the same elevation as the rest of the bridge deck. Per regulation, a 2.0% transverse slope will be formed into the deck angling away from the center of the roadway. Specific deck details can be found on Design Sheet V5.

The Willow Creek Bridge will require a barrier rail, a separation rail, and a pedestrian rail. Based on selection criteria from Figure 5.8.1.2.1 of the Iowa DOT Bridge Design manual,

this bridge meets but does not exceed the requirements for a 34" TL-4 barrier rail. In order to minimize the design requirements and ease construction, standard barrier rail cross-sections were selected for this project. The barrier rail and separation rail are to be matching cast-in-place F shaped rails following detail sheet 1028A from the Iowa DOT archives. An additional steel railing is to be attached to the top of the railing on both sides to further protect pedestrians and bikers as shown in detail standard sheet 1029C.

Both the separation rail and the pedestrian rail are designed in accordance with Iowa DOT section 5.8.1.2.3. This sets the requirements for the height of the rails when bikers and pedestrians are present on the sidewalk. Per the AASHTO and DOT standards, a 72" pedestrian rail is to protect the sidewalk from the edge of the bridge. This section is to be a chain link fence similar to the recent Mason City bridge project and will match Iowa DOT standard sheet 1029C.

Based on the selections from Section 5, the bridge beams are to be hybrid composite beams. Because there is no set standard in the Iowa DOT Bridge Design Manual for this style of beam, requirements were assessed for the pre-stressed concrete beam as these two beams have very similar design principles. Design guides from Hillman Composite Beam Company, which can be found in the appendix section, a design configuration using 10 HCB beams was selected for this project. The beams selected include an integral bridge deck form allowing rapid construction of the bridge deck once beams are placed.

Having selected designs for the top components of the superstructure, dead and live loads were tabulated for the bridge. A robot analysis was conducted to determine the line loads for an HL-93 truck per AASHTO requirements and added to the component loads of the bridge. Having the final design loads for the bridge, an average line load was determined for each beam on the bridge. In consulting with John Hillman at Hillman Composite Beams, a 36" deep beam was selected for this bridge based on loads and span. Further specifications for the design of these beams will be available when an order for the final design of the bridge is requested.

6.2. Bridge Substructure Design Details

Like the existing bridge crossing Willow Creek, there will be a sharp drop in elevation at the abutments. This will be facilitated by the design of a retaining wall at the end of each abutment. In order to create a rapid design solution for the bridge project, the retaining wall is to act as a bearing point for the beams that span across the bridge. The retaining wall will sit on top of pile cap, which is placed below ground elevation. The pile cap by ground pressures on a series of H piles driven into the soil below.

For this design, the weight of the superstructure plus the estimated weight of the retaining wall and pile cap were distributed to nine steel piles. Based on the preference of the Iowa DOT, steel piles are to be HP 10x57 for this style of bridge. Using nearby well drilling data for soil calculations, the foundation is designed to have 9-60 foot H piles at each abutment. The outside piles are to be skewed as shown in design sheet V4.

The concrete pile cap, which is to sit on top of the steel piles, will be pre-cast. This cap will be 44 feet long, 3' wide and 3' deep matching details set out in Iowa DOT Bridge Design Manual Section 6. There will be a whole cutout lined with corrugated steel pipe for each steep pile to be fitted in during placement. Once the pile cap is placed, quick high strength concrete will be placed in the holes and allowed to harden and create a bond between the pile cap and the steel piles.

Once the pile cap has been placed, a retaining/bearing wall will be placed over the foundation. This structure will also be pre-cast and will be connected to the pile cap through rebar dowels and slick concrete applied between the cap and the wall before placement. Dimensions for the retaining wall are found in the design sheets for the foundation in the back of this design report.

Having the foundation in place, the hybrid composite beams are to be placed on 8"x22"x1/2" laminated neoprene bearing pads surrounded by a rubber filler joint cover. Rebar connections directly into the HCB and an integral concrete abutment will attach the bridge to the foundation wall. An approach slab will be separated from the bridge by an expansion joint and will follow Iowa DOT standard detail BR-201.

Due to the elevation of the surrounding riverbed and roadway, a wing wall is required in this construction project. Typically, this wing wall would be integrally cast with the retaining wall and bridge abutment however, in order to speed construction; this component will be built separate from the cast-in-place unit. This takes the wing wall out of the timeline for the completion of the project. Similar to the existing wing wall, this design will skew at a 45-degree angle away from the roadway for 10' until lower and upper elevations match.

6.3. Bikeway Design Details

The bikeway was designed according to SUDAS, the Iowa DOT Design Manual, and ADA requirements. The path will be 10 ft. wide with two shoulders to create a 2 ft clearance and 6 in. thick pavement. The 6 in pavement will be used instead of the 5 in pavement for the entire bike path throughout the project. This is because of the use of vehicles on the paths to clean and maintain them. The slope of the path will have a running slope that is no greater than 5% and a cross slope of 1.5% to adhere to ADA guidelines. A 4:1 slope will also be used from the shoulder to the existing ground. Using this slope no handrails will be required along the path. When the bikeway meets the street there will be a 4' by 10' concrete curb ramp with cast iron detectable warning. Cast iron was chosen because of the wear and tear that would happen from the plows on the sidewalks.

Two culverts were need along the project. The locations of these culverts were at stations 00+50, 26+00. The culvert at 00+50 was designed using the rational method. The other culvert could not be designed using the rational method because of the land cover. Culvert 1 located at 00+50 and had an area of 45 acres. This pipe will be 38 ft. in length and need to be two feet in diameter. Rip rap will need to be placed in this area after the bike path is added. The area currently has vegetation which will be removed and the grade of the bike path will make two flows of water into a very confined space. Culvert 2 will be placed at

station 26+00. This culvert has a significantly higher flow and area of culvert 1. Because of the larger area the SCS method was used to calculate the culvert size. This culvert will need to be 40 inches in diameter and be 20 ft. long. During the size visit this area had running water and could affect the build timeline depending on the current weather conditions. No culverts will be needed in near the Kraft Jello plant because of the preexisting storm sewer conditions and the flat land. The path was designed to have a smaller profile in this area for that reason.

6.4. Hydraulic Analysis

The hydraulic analysis is based on the direction of LRFD (Load Resistance Factor Design) Bridge Design Manual from Iowa DOT. The purpose of this hydraulic analysis is to prevent the potential damage due to the change of bridge structure after construction in the future. River channel information of Willow Creek to predict the water flow condition for the 50-year, 100-year, 200-year, and 500-year flood through the channel from upstream to downstream of the bridge was collected from Stream Stat. The change in the abutments and bridge will result in a change in river flow dimensions. Therefore, scour protection, freeboard and backwater need to be considered in analysis.

Stream Stat as a USGS web based program has been used to get the drainage area, stream channel information and a number of statistics for peak-flow in different flood duration. This data was run through a HEC-RAS analysis program. For this analysis importing geometry data from AutoCAD civil 3D was collected with a complete existing channel and cross section drawing by using contour lines and approximated bridge design. Output analysis showed the changes in water elevation and flooding before and after construction.

According to the analysis results got from HEC-RAS program, backwater exactly met the requirement of the Iowa DNR, which is the maximum change of water surface elevation upstream of the bridge at the 100-year flood level should less than 1 foot . This change is limited to 9 inches. Using excel to do a comparison, it is very clear that even for 500-year flooding, the water surface elevation only has a 0.7 feet difference from before to after construction, about 149.06 feet away from the bridge location.

For freeboard, the distance between the water surface and the bottom of the bridge, the requirement is also based on the guidance of flood plain management from Iowa DNR . This guidance points out that the minimum vertical distance between the bottom of the superstructure and Q50 is 3 feet for replacement bridges and road embankments. In initial analysis, the freeboard was only 0.6 feet after construction. This meant the proposed design need to be modified. Therefore, the superstructure of bridge will be move up 3 feet from the existing design.

The last and the most important part of hydraulic analysis is scour protection. For this Bridge and Bikeway project, guided banks are one of the most common countermeasure that are used to prevent the scour damage result from the stream flow. Riprap is required to be placed 2 feet deep at the point of scour around the bridge. Based on FHWA calculations, the maximum scour depth is 6.24 feet. In order to protect against larger

flooding the riprap apron will extend a distance of 6.5 feet from the edge of the abutment. Riprap boulder sizing will be approximately d_{50} of 16”.

Section VII Cost and Construction Estimates

7.1. Construction Work Plan

The construction work plan was broken into two schedules for the bikeway and the bridge. This was done as only the bridge construction impacts traffic closure of 12th St. Estimates were made based on past experience with construction projects and referencing of previous Iowa DOT projects. The projected length for the bikeway is 5 weeks as shown in Figure 7.1.1. The bridge should take about 7 weeks to complete based on the work plan shown in Figure 7.1.2.

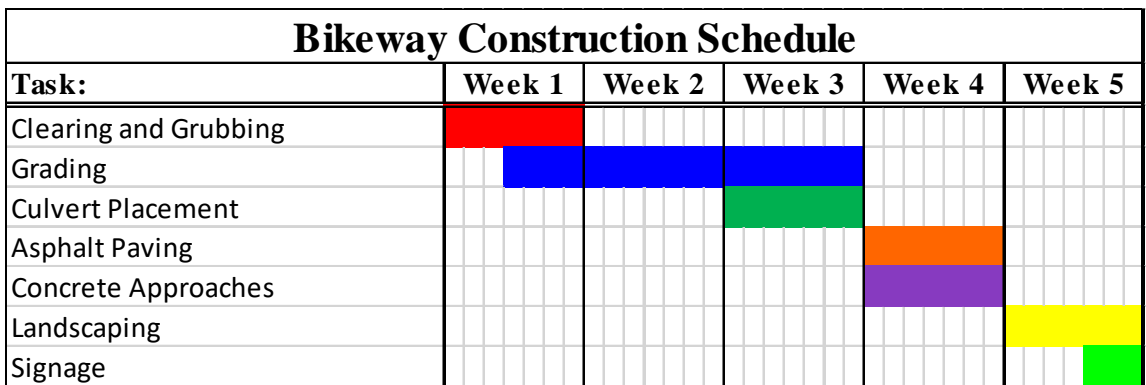

Figure 7.1.1: Bikeway Schedule

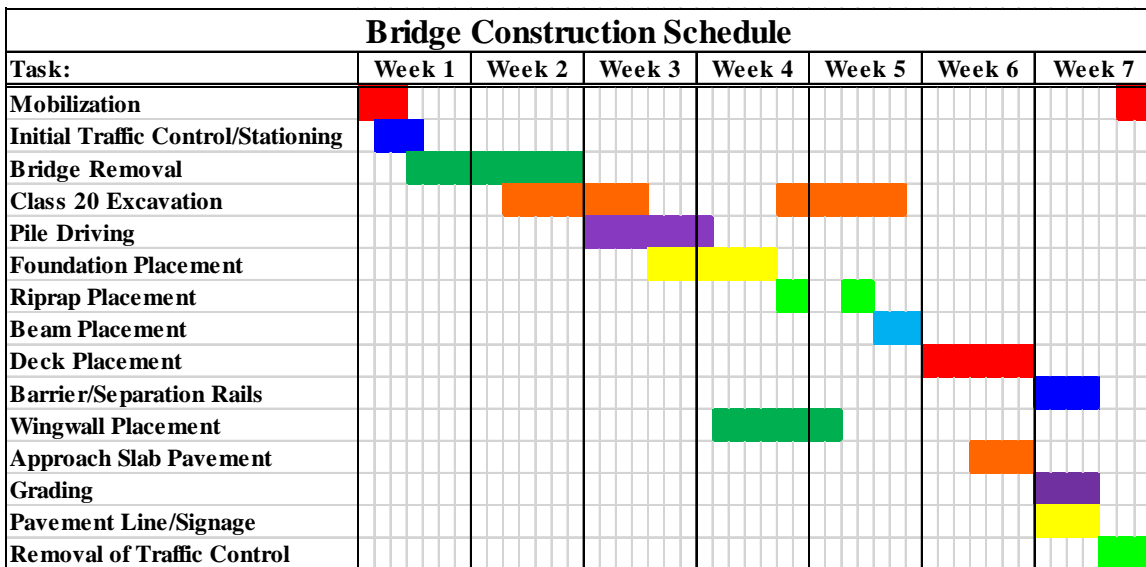

Figure 7.1.2: Bridge Construction Schedule

One of the focuses of this project was reducing the closure of the road. The bikeway and bridge were planned to be built during two different periods. Knowing this a few things could be done during the bridge schedule from the bikeway schedule to limit the closure. All work after 12th St to North Taft Ave should be done during the bridge construction

schedule. This work would consist of grading on the North side of 12th St, paving the new built up section, and the placing of the barrier rail. This should all be done during the bridge build when the road is already closed. The culvert could also be placed on the South side of 12th St before final grading. Every other aspect of the bikeway will not be in that critical area.

As the goal for bridge construction is rapid construction, specific detail must be given to the design of this construction plan. Based on the experiences from the Missouri DOT Safe and Sound bridge project, our goal was to create a time schedule that would allow for completion in under 50 days. The mobilization, stationing, and bridge removal time estimates were based on previous projects. These processes can occur simultaneously. Once the bridge is partially removed, the goal is to target work on one abutment and follow with the second abutment in series throughout the foundation design (ie: once pile driving is done on one abutment, it is started on the other).

Once piles are driven for the new bridges, the pile caps are placed. Using quick high strength concrete to create the connection between the cap and the piles, the foundation base will need to set for about two days before further work can be done. Doweling reinforcement and a cement mortar are used to create the bond between the pile cap and the retaining wall. Once the retaining wall is set, the wing wall, riprap and final grading for the abutment can be completed.

Once both abutments are in place work on the superstructure of the bridge may begin. HCBs can be set and filled with concrete in a day. Once this is done, two days are needed for the concrete to harden before deck work can be done. Because the bridge beams utilize integral deck forms, less work is required in creating the concrete bridge deck speeding construction.

After the deck is placed, the remainder of the bridge construction components can be completed in parallel. Tentatively the construction schedule aims for a 50 day completion time but the goal would be finished sooner than that.

7.2. Material Estimates

The estimates of materials required to complete this project are based on the preliminary design information from the design sheets and appendix notes. Estimates were approximated for each component of the project based on approximate sizing and material usage for similar projects that were reviewed. The table below shows a breakdown of material estimates for the construction of the bridge and bikeway. A further breakdown of each material and each component of the project can be found in the appendix and design sheets.

MATERIAL COST SUMMARY				
MATERIAL	UNIT	QUANTITY	UNIT COST	TOTAL COST
CONCRETE	CU. YDS.	269.6	110.00	29650.94
STRUCTURAL CONCRETE	CU. YDS.	191.5	600.00	114884.40
ASPHALT	CU. YDS.	1302.34	74.00	96373.16
EPOXY COATED REBAR	LBS.	95902	1.07	102615.14
STAINLESS STEEL REBAR	LBS.	4620	1.25	5775.00
STEEL PIPE HANDRAIL	LIN. FT.	150	25.00	3750.00
COMPOSITE BEAM	LIN. FT.	666	350.00	233100.00
HP PILE	LIN. FT.	1104	38.00	41952.00
BRG. 8" RIPRAP	TONS	90	50.00	4500.00
BRG. ENGR. FABRIC	SQ. FT.	350	4.00	1400.00
BRG. BACKFILL MAT.	CU. YDS.	150	15.00	2250.00
PED RAIL. CHAINLINK FENCE	LIN. FT.	79	70.00	5530.00
PED. TRAC. PADS	--	16	25.00	400.00
PED. CROSSWALK SIGN	--	6	100.00	600.00
PED. STOP SIGN	--	16	20.00	320.00
MASON CITY BIKE SIGN	--	3	20.00	60.00
PED. TRAIL CUT	CU. YDS.	5870	8.00	46960.00
PED. TRAIL FILL	CU. YDS.	7254	10.00	72540.00
36" CULVERT	--	40	105.00	4200.00
18" CULVERT	--	40	40.00	1600.00
8" CULVERT	--	84	20.00	1680.00
GUARD RAIL END TERMINAL	--	2	2250.00	4500.00
REVTMENT, CLASS B	TONS	75.6	45.00	3402.00
ROW ACQUISITION	--			20000.00
			COST OF MATERIALS	798042.64
SERVICE COST SUMMARY				
ITEM	UNIT	QUANTITY	UNIT COST	TOTAL COST
CLASS 10, EXCAVATION	CU. YDS.	150	25.00	3750.00
REMOVAL OF EXISTING BRIDGE	LUMP	1	50000.00	50000.00
SAFETY CLOSURE	LUMP	1	2500.00	2500.00
MOBILIZATION	LUMP	1	10000.00	10000.00
SEEDING AND FERTILIZING	ACRE	50	2.50	125.00
SILT FENCE	LF	900	3.75	3375.00
SEDIMENT CONTROL	LUMP	1	500.00	500.00
CLEARING AND GRUBBING	ACRE	5	1000.00	5000.00
GRANULAR SHOULDER	SQ. FT.	240	4.00	960.00
BANK SHAPING	SQ. YDS.	50	24.00	1200.00
PAVEMENT REMOVAL	LUMP	2	600.00	1200.00
PAINTED PAVEMENT	STA.	4	350.00	1400.00
BRG. SOIL COMPACTION	SY. YDS.	175	45.00	7875.00
			COST OF SERVICES	87885.00
			COST OF MATERIALS	798042.64
			SUBTOTAL COST	885927.64
			CONTINGENCY	-
			TOTAL COST	890000.00

Figure 7.2.1: Material quantities and costs

7.3. Preliminary Cost Estimates

Preliminary costs are based on the material quantities found in the previous subsection. By using the bid records for project listings for the past year, the approximate per unit cost of each component of the bridge and bikeway design was estimated. A preliminary beam cost estimate was given for the hybrid composite beam from the Hillman Composite Beam

Company. All costs listed in the figure above include labor, machine, transportation and incidental costs for the project.

Additional services not included in the material cost tables are included in the services costs. This includes items that do not have component contribution to the project. Many of these items include the cost of labor, logistics and contractor materials not included in the final project. These costs were also estimated based on previously bid projects similar to the Mason City project.

The final bid cost for the project includes an approximate five percent additional contingency to account for additional costs that were not anticipated in this report. The cost for the project lies in the range of estimated project costs listed on the Iowa DOT website. The final cost for the design and construction of the Mason City Bridge and Bikeway at Willow Creek is \$890,000.00. This is further broken down into \$700,000.00 for the bridge and \$190,000.00 for the bikeway. The bridge includes Section 2 of the bikeway construction between the two sections of Taft Ave. This was done as this portion connects to the bridge and would require lane closure along 12th St.

Section VIII Conclusions

8.1. Conclusions

The bridge design was a key aspect for this design process. By using the HCBs the bridge construction time could be reduced significantly. The current design is for two lanes and a bike lane and expansion of the bridge could easily be considered with the current calculations. Using our current resources, it is believed that the bridge will need to also be raised because of hydraulic restrictions. This should be further researched due to the significance that would require of building up the roadway and adding more fill.

The bikeway will add 1.8 miles of trail that can be built quickly without having a large effect on the area. The bikeway path misses many different obstructions and obstacles to create simplicity. The design does not use new technologies but optimizes the current area to reduce cost and impact. The path will connect the Northwest side of the town and allow many people to be able to safely navigate the city through alternative transportation.

The bridge and bikeway could be one major project or be broken up. The plans allow for adjustments of the phasing of the project. The bridge and bikeway share about 700 ft. have space with the bikeway needing expansion of the road for safe crossing. The other sections of the bikeway could be completed connecting the workers to be connected to the bikeway without have to cross the river.

Before or after work is done on this area, the route will remain a busy area. The work required will help improve this congestion by taking people out of their cars and providing a quick build time bridge. This project could highlight new technology in the HCB beams while fixing many current issues. The final cost of the project is estimated to be \$890,000.00.

Section X Bibliography

- (2015) *ACI 318-14, American Concrete Institute.* (March 2017).
- Braja M. Das (2014), *Principles of Foundation Engineering: Eighth Edition* (February 2017). Cengage Learning.
- David A. Chin (2013), *Water-Resource Engineering: Third Edition* (April 2017). Pearson.
- Iowa DOT Deign Manual (February 2017).
<https://iowadot.gov/bridge/policy/LRFDBridgeDesignManual.pdf>
- Hillman, John R. (2013). *Hybrid-Composite Beam Design and Maintenance Manual.* (March 2017). Hillman Composite Beam Company.
- Lagasse, P.F., Clopper, P.E., Zevenbergen, L.W. & Ruff, J.F. (2006). *Riprap Design Criteria, Recommended Specifications and Quality Control.* Washington (D.C.): (April 2017). National Academy Press.
- Narendra Taly (2012), *Highway Bridge Superstructure Engineering* (March 2017). CRC Press.

Section X Appendix

10.1. Hydraulic Analysis

Section A:.....32

A.1. Executive Summary.....32

Section B:.....33

B.1. Purpose.....33

B.2. Procedures.....33

Section C:.....35

C.1. Backwater Analysis.....35

C.2. Freeboard Analysis.....37

C.3. Scour Protection.....38

Section D:.....40

C.1. Conclusions.....40

Section A Executive Summary

A.1. Executive Summary

The following hydraulic analysis is based on the direction of LRFD (Load Resistance Factor Design) Bridge Design Manual from Iowa DOT. The purpose of this hydraulic analysis is to prevent the potential damage due to the change of bridge structure after construction in the future. River channel information of Willow Creek to predict the water flow condition for the 50-year, 100-year, 200- year, and 500-year flood through the channel from upstream to downstream of the bridge was collected from Stream Stat. The change in the abutments and bridge will result in a change in river flow dimensions. Therefore, scour protection, freeboard and backwater need to be considered in analysis.

Stream Stat as a USGS web based program has been used to get the drainage area, stream channel information and a number of statistics for peak-flow in different flood duration. This data was run through a HEC-RAS analysis program. For this analysis importing geometry data from AutoCAD civil 3D was collected with a complete existing channel and cross section drawing by using contour lines and approximated bridge design. Output analysis showed the changes in water elevation and flooding before and after construction.

According to the analysis results got from HEC-RAS program, backwater exactly met the requirement of the Iowa DNR, which is the maximum change of water surface elevation upstream of the bridge at the 100-year flood level should less than 1 foot . This change is limited to 9 inches. Using excel to do a comparison, it is very clear that even for 500-year flooding, the water surface elevation only has a 0.7 feet difference from before to after construction, about 149.06 feet away from the bridge location.

For freeboard, the distance between the water surface and the bottom of the bridge, the requirement is also based on the guidance of flood plain management from Iowa DNR . This guidance points out that the minimum vertical distance between the bottom of the superstructure and Q50 is 3 feet for replacement bridges and road embankments. In initial analysis, the freeboard was only 0.6 feet after construction. This meant the proposed design need to be modified. Therefore, the superstructure of bridge will be move up 3 feet from the existing design.

The last and the most important part of hydraulic analysis is scour protection. For this Bridge and Bikeway project, guided banks are one of the most common countermeasure that are used to prevent the scour damage result from the stream flow. Riprap is required to be placed 2 feet deep at the point of scour around the bridge. Based on FHWA calculations, the maximum scour depth is 6.24 feet. In order to protect against larger flooding the riprap apron will extend a distance of 6.5 feet from the edge of the abutment. Riprap boulder sizing will be approximately d_{50} of 16”.

The following report details the calculations and analysis materials and methods as well as a fully detailed result of the design parameters related to the hydraulics of the bridge. Note that this report has been modified slightly from its original form to match the final design report formatting.

Section B Introduction

B.1. Purpose

The purpose of the hydraulic analysis is to determine the river flow condition through the channel from upstream to downstream of the Willow Creek Bridge. This is especially necessary around the bridge, which is being redesigned in this project. Per Iowa DNR and DOT standards, hydraulic conditions for any waterway construction must be compared before and after construction to determine if the design is appropriate in this location.

A hydraulic analysis measures the changes in flow of a river due to construction up and downstream. This measures river flows at different flood stages to ensure that changes in water levels do not influence flood zoning and natural habitats. This limits the design of construction super and substructures and how long spans can be in the redesign of new bridges. Since any change of piers and abutments will affect the river flow through bridge and scour potential of the bed, measurements must be taken before design and construction can begin. The change of water surface elevation, freeboard after construction and scour condition, will be measured in hydraulic analysis consequently alleviating the risks from flooding and other problem result from water flow change.

B.2. Procedures

Stream Stat is a USGS web based program that can provide discharge information for particular point and provide accurate data of channel conditions. It is very convenient in hydraulic analysis and it is the first step to start getting a number of hydraulic data for the subsequent analysis. Once the location of the bridge is pointed out in Stream Stat the program will delineate a watershed from the bridge location shown in Figure 2.2.1 and compute the drainage area, which is 83.7 square miles. Stream Stat also provides peak-flow statistics for different flood durations shows in Table 2.2.1. This is very important information in hydraulic analysis. These peak flow data will be used in HEC-RAS analysis program.

Statistic	value	unit
2 yr	1640	ft ³ /s
5 yr	3540	ft ³ /s
10 yr	4280	ft ³ /s
25 yr	6280	ft ³ /s
50yr	7590	ft ³ /s
100yr	8860	ft ³ /s
200yr	11300	ft ³ /s
500yr	12200	ft ³ /s

Table B.2.1: steady flow statistic data for each profile.

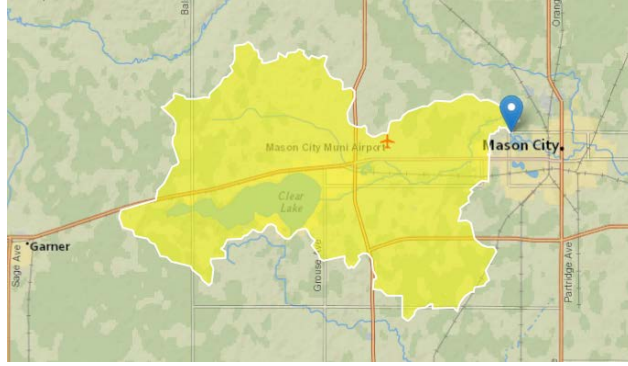

Figure B.2.1: Watershed of Willow Creek.

HEC-RAS analysis program is another popular tool used in hydraulic analysis, and has been used to model existing channel and cross sections in this project, in order to predict the hydraulic analysis after bridge construction. Geometry for the river cross-sections were taken at several points up and downstream of the river using contour lines in AutoCAD Civil3D. These cross-sections were then exported to HEC-RAS for analysis.

With cross-section data and river flows at different flood stages, HEC-RAS analysis could be run. Based on field observation per the Iowa DOT manual, a manning's coefficient (n value) of .04 was selected for this project. Because the limiting constriction of flow along the creek is the bridge structure at 12th St., a cross-section of the bridge needed to be inputted into the river cross-sections of the bridge as shown in Figure 2.2.3. The bridge cross-sections were based on approximations made early in the design of the bridge. Based on hydraulic concerns, the cross-section of the bridge was made to approximately match that of the existing bridge with the exception of the width.

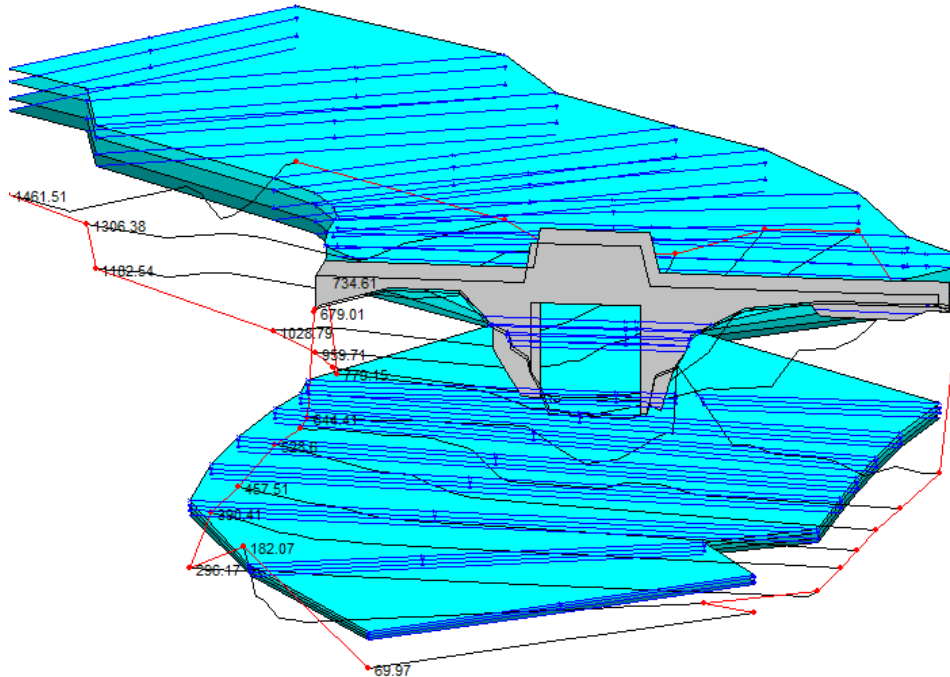

Figure B.2.3: 3D view of bridge

Data values for the 50-year, 100-year, 200-year and 500-year year floods were entered from Stream Stat for each analysis for both the before and after construction profiles. A mean basin slope of 1.58% was given to the profile for flow. Once analysis was set up, outputs were collected and analyzed as detailed in the remainder of the report.

Section C: Hydraulic Analysis

C.1. Backwater Analysis

Backwater is the maximum change between the existing normal water surface elevation and the water surface elevation resulting from the obstruction to flow. In order to construct a redesigned bridge, bridge abutments have to be replaced as a requirement. The new abutments will affect water flow rate and water levels upstream of the bridge. As Figure 3.1.2 and Figure 3.1.3 shows below, water level is increased due to change of the bridge abutments. These two figures both are cross section of bridge upstream from the same channel station. This can cause changes in flooding patterns which is already a concern upstream of this bridge, which is an existing flood basin.

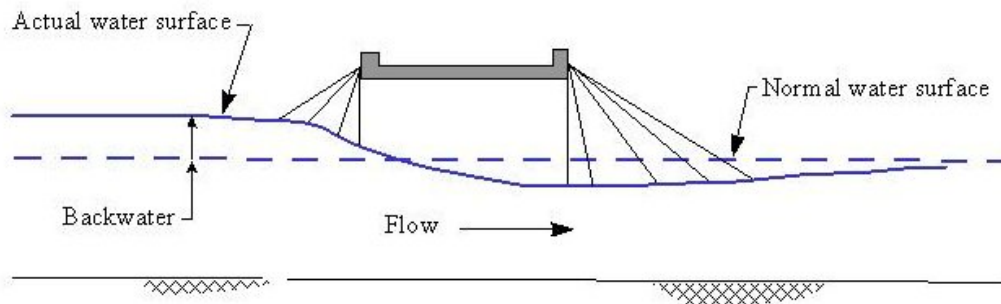

Figure C.1.1: How the backwater come from

According to the state's flood plain management and dam safety criteria from the Iowa Department of Natural Resources, backwater for Q100 should be less than or equal to 1.0 feet for replacement bridge at high or moderate damage potential areas. This measurement is taken at a distance of 1.5 times the bridge width upstream of the superstructure (60ft). As the comparison graphs (Figure C.1.2 and C.1.3) show below, backwater is only 0.3 feet for Q100, which satisfies the safety criteria of IDNR.

As Figure 3.1.4 shows, even for Q500, the change of water surface at station 864.06, 149.06 feet away from bridge, is only 0.7 feet. It is much less than the limitation according to the IDNR, which means backwater considerations for the proposed bridge will not have a lot effect for water flow condition. This also shows that the new bridge meets 100 year design life criteria.

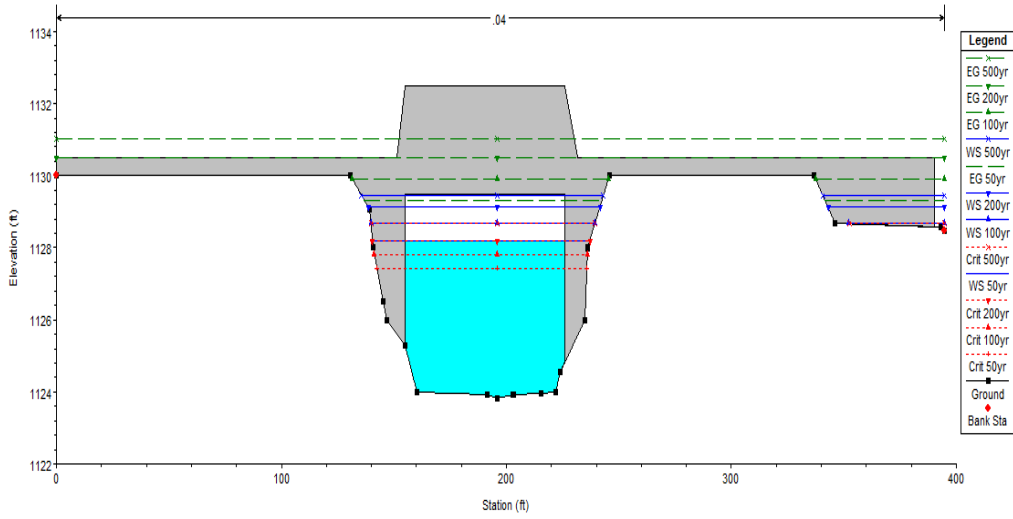

Figure C.1.2: Cross section of bridge upstream before construction

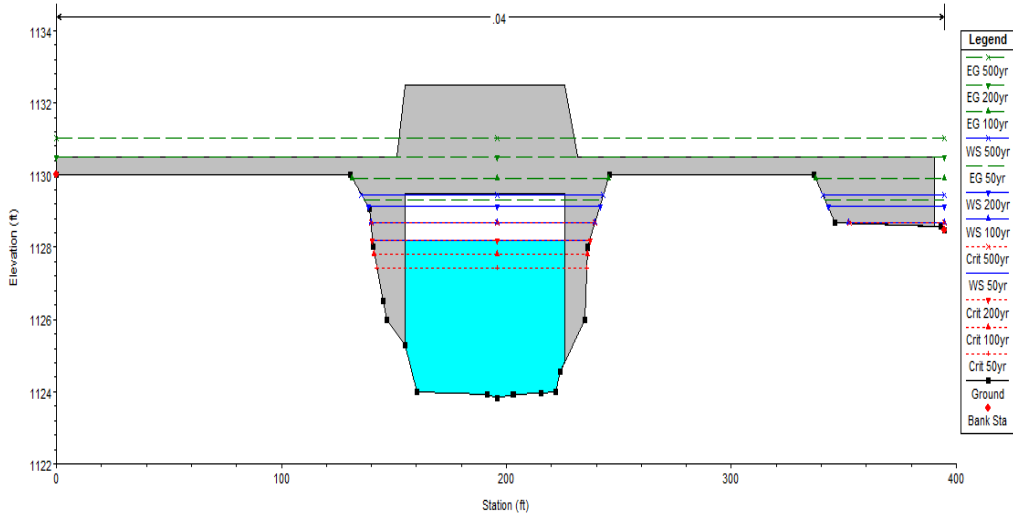

Figure C.1.3: Cross section of bridge upstream after construction.

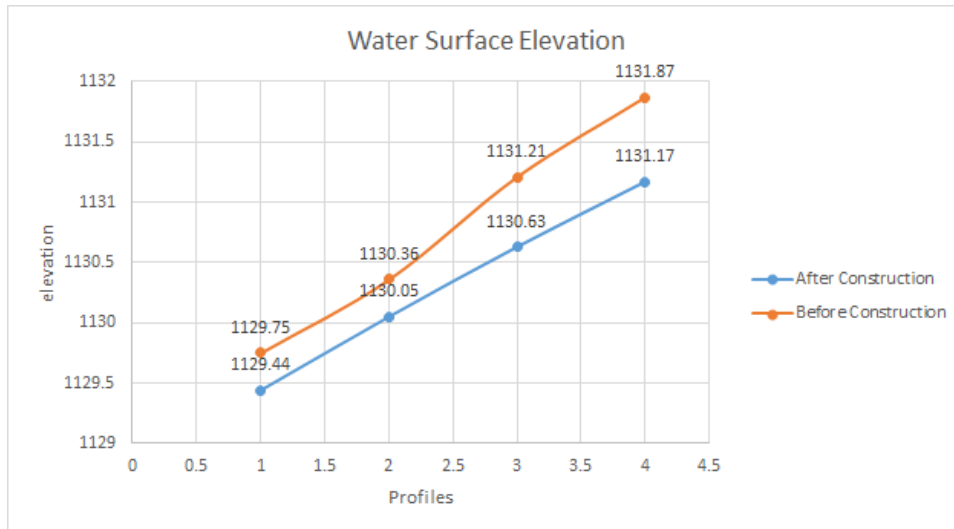

Figure C.1.4: Comparison of water elevation before and after construction at 864.03 station.

C.2. Freeboard Analysis

Freeboard is the vertical distance between the water surface and the bottom of bridge superstructure. It is a factor of safety usually for purposes of floodplain management. If the freeboard levels at expected flooding stages is too small or nonexistent, floodwaters could be overtopping the bridge and run the risk of washing out the structure. This can cause considerable damage and harm to the public and the environment. There are several unknown elements need to be considered during freeboard evaluation, such as wave action, wind set-up of water surface.

According to the safety criteria from Iowa DNR, the minimum 3 feet of freeboard is required for Q50. Iowa DOT also points out that if streams draining less than 100 square miles in rural areas or less than 2 square miles in urban areas, 3 feet freeboard is not required. But, in order to guarantee the safety for Q200, even Q500, 3 feet freeboard is desirable. The stream draining is 83.7 square miles in this project, which is less than 100 square miles.

As Figure 3.2.1 and figure 3.1.2, the cross section of existing bridge show, the freeboard, vertical distance between the water surface and the bottom of bridge superstructure is about 1.3 feet at upstream of bridge and 2.3-feet at downstream of bridge. After construction, the freeboard of proposed bridge is a little bit shorten than before, as Figure C.2.2 and figure 3.1.3 show, they are 0.6 feet and 2 feet from Q50 water surface elevation to the superstructure for up and downstream of bridge. Obviously, whatever before and after construction, freeboards are all not meet the requirement from the IDNR.

Therefore, the proposed design need modify because of the substandard freeboard. Based on this initial analysis, the superstructure elevation was moved up about 3 feet in order to meet the safety criteria from the bridge structure.

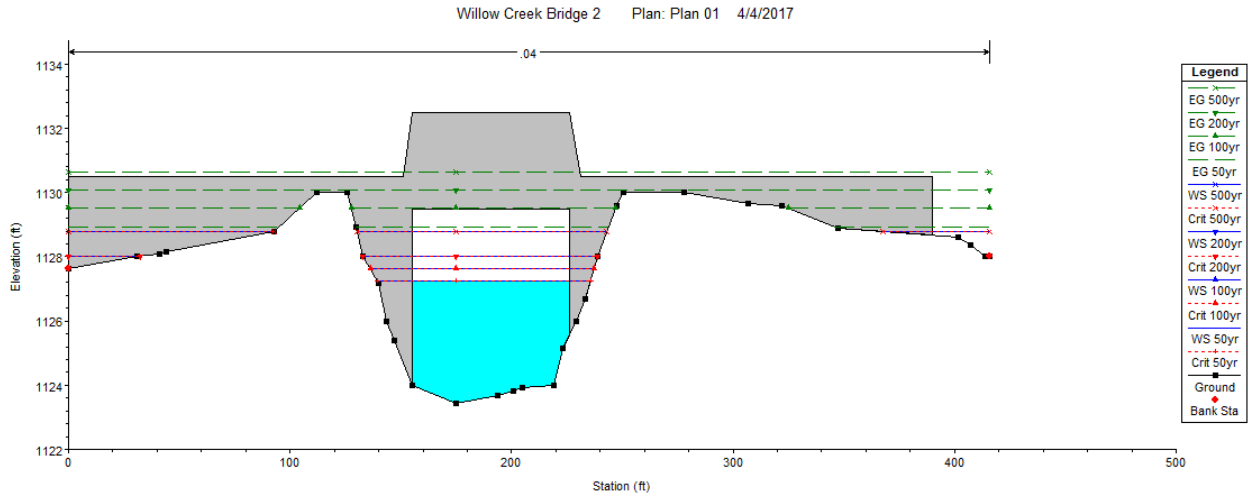

Figure C.2.1: Cross Section of River Station 726.81 BR downstream before construction

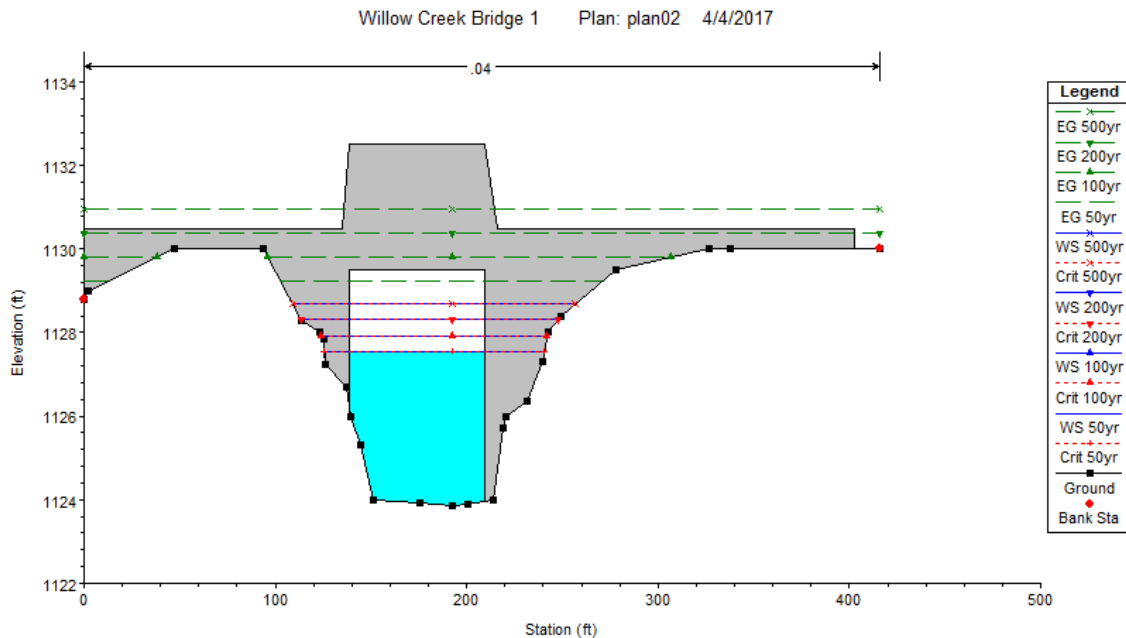

Figure C.2.2: Cross Section of River Station 726.81 BR downstream after construction.

3.3. Scour Protection Design

Scour protection is an important part of bridge maintenance. Scour refers to the erosion of soil, which is a particular concern when water flow is altered such as around bridge foundations. Due to the increased water flow rates after bridge construction, around bridge abutments, a part of sediment, such as sand and rocks, might wash away by hydrodynamic forces. According to statistical data from USGS, scour caused 46 of 86 bridge failures from 1961 to 1976.

In order to protect bridge abutment from scouring, there are several options that can be used. Placing coarse stone along the riverbanks is a common countermeasure. Stone lines stand out a short distances into the river channel away from the abutments. Guide bank or parallel walls are another way to protect bridges. They require rock embankments at bridge

abutment, thereby improving the flow alignment and moving the local scour away from the bridge abutment. In this project, guide bank will be used to prevent scour from the foundation of the proposed bridge. Since, comparing to the existing bridge, two-side abutment will become closer to the water channel.

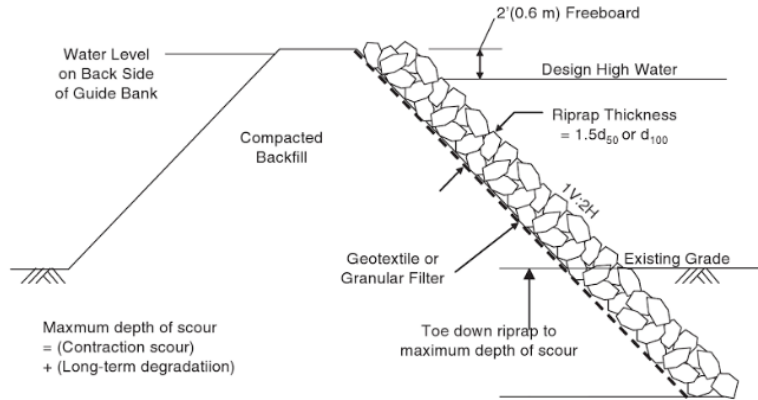

Figure C.3.1: Typical cross section through guide bank.

According to the requirement of the Iowa DOT, once stream velocity exceeds 8 to 10 feet per second, riprap need to be considered. From the analysis of HEC-RAS, the velocity of channel is 8.51 at 200-year flow, which is larger than 8 feet. Therefore, it is necessary to put riprap around the abutment to prevent the scour. By calculation, average contraction scour depth is 6.24 feet when stream flow upstream of bridge raise up to 3410 cfs at Q200. The depth of riprap should toe down to maximum depth of scour as Figure C.3.1 shows above. In addition, maximum depth of sour is equal to the sum of contraction scour, long-term degradation and local scour. Since there is no flow in the flood plain for Q200, the local scour depth is zero in the proposed design. Assuming the long-term degradation will not affect scour depth considerably, then, the maximum scour depth is 6.24 feet.

As the Iowa DOT requires, a minimum 6 feet distance will be needed from the toe or to the maximum scour elevation. In this project, in order to protect the bridge abutments more effective, 6.5 feet depth riprap guide bank will be set based on the 6.24 maximum scour depth, and also included 2-feet freeboard up water surface. Since, according to the suggestion from the Iowa DOT, thickness of riprap is 2 feet, which equal to 1.5 times of D_{50} . It meant the median stone diameter of riprap is 16 inches. Generally, in order to prevent some uncertainties, the thickness of riprap should be increased by 50% under water. Therefore, the riprap thickness is 3 feet when it placed under water.

As Figure C.3.2 shows below, because the slope of riprap revetment should be 2 horizontal to 1 vertical, then, the horizontal dimension of riprap revetment is 13 feet indicated in the side plan view. Also, scour is more likely to happen at upstream face of the abutment. In this project, additional riprap is placed to extent the upstream coverage. That is why the horizontal dimension of riprap revetment at upstream side is larger than the downstream side.

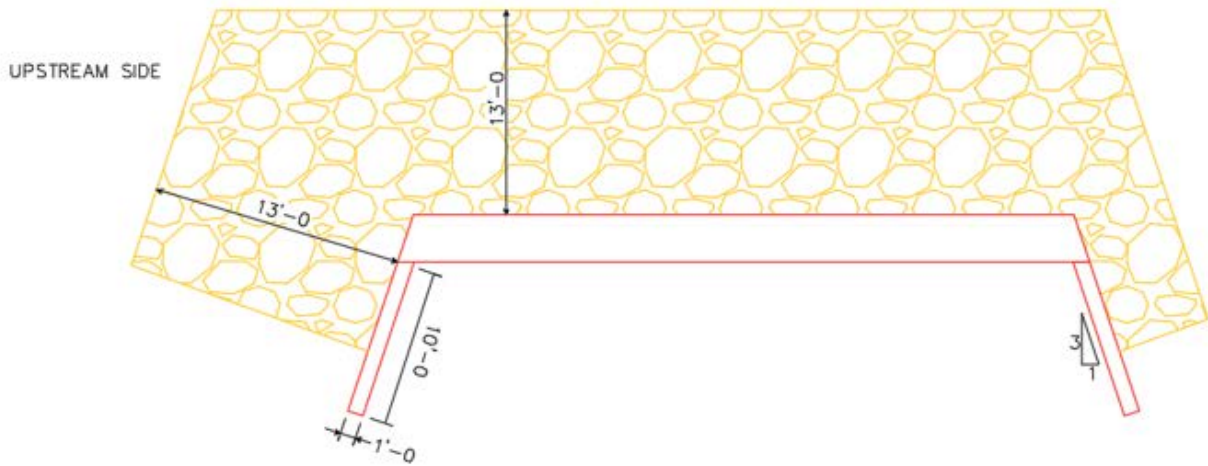

Figure C.3.2: Scour protection detail.

Section D Conclusion

Section D.1. Conclusion

Overall, proposed bridge is appropriate to Bridge and Bikeway Project for Mason City, IA. Comparing the water surface elevation before and after construction, backwater is only 0.3 feet for Q100. The criteria from IDNR requires backwater in high damage potential area is no more than 1-foot. The proposed design is exactly meet the requirement of IDNR. For the freeboard, it results proposed bridge make a change after the initial analysis. Because the Bridge Design Guide state that the minimum freeboard for Q50 is 2 feet at up and downstream of bridge. After moving the superstructure up 2 feet, freeboard become 2.6 feet at upstream of bridge and 4 feet at downstream of bridge after construction, meet the requirement.

According to the bridge condition and surrounding environment, Guide Bank is chosen to be the best countermeasure to protect the bridge abutment from the scour produced by the water flow change after construction. In this project, 2-foot thickness of riprap will be set from the back side of upstream through the bridge opening to the downstream embankment about 25 feet. And it will also toe down to the maximum depth of scour, which is 6.24 feet by calculation.

10.2. Project Design Sheets

Title.....42
Cross-Sections.....43
Estimate Sheets.....45
Traffic Details46
Storm Sewer Data.....49
Bikeway Alignment.....50
Bridge Design.....63

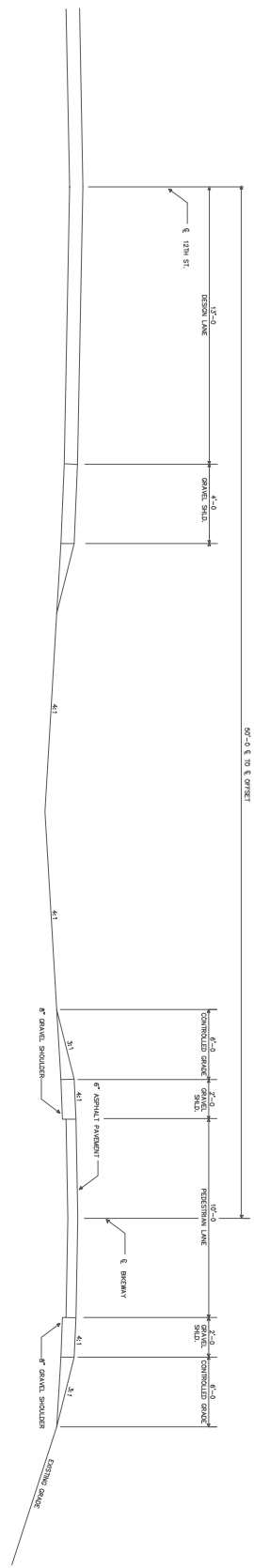

Tافت AVe. (TYP.)
STATION 14+00.00

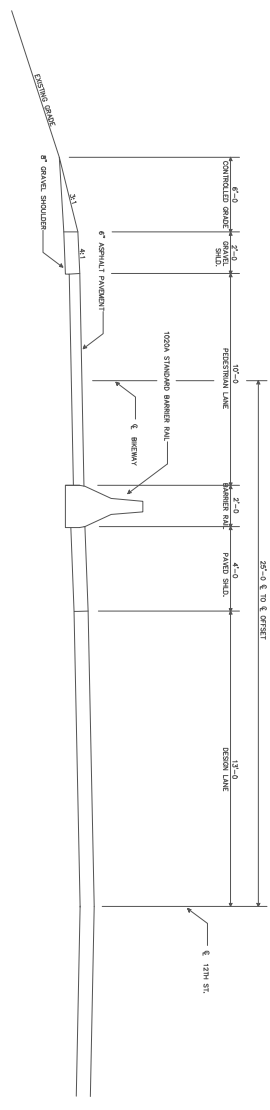

E. WILLOW CREEK BRIDGE
STATION 28+42.18

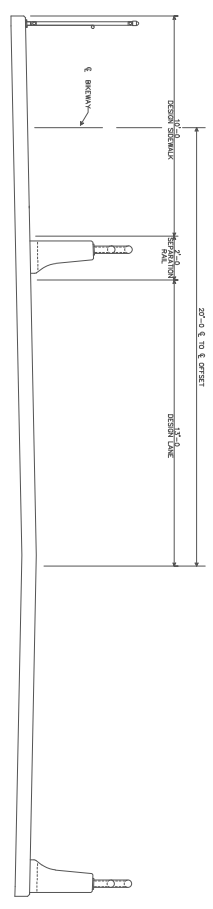

WILLOW CREEK BRIDGE BRIDGE
STATION 28+42.18

DESIGN FOR 0° SKEW
75'-0 x 40'-0
BRIDGE AND BIKEWAY
 SINGLE SPAN BRIDGE
BIKEWAY CROSS-SECTIONS
 STATION 28+42.18 = CENTERLINE 12TH ST. BRIDGE
CERRO GORDO COUNTY
 MAY 2017
 CITY OF MASON CITY
 DESIGN SHEET NO. _____ OF _____ FILE NO. _____ DESIGN NO. _____

PROJECT:	005
DATE :	5/1/2017
DRAWN BY:	ZRG
REVISION:	

THE UNIVERSITY OF IOWA
CIVIL AND ENVIRONMENTAL ENGINEERING
 4105 SEAMANS CENTER FOR THE
 ENGINEERING ARTS AND SCIENCES
 103 S CAPITOL ST
 IOWA CITY, IOWA 52242
 PHONE: 319.335.5647
 FAX: 319.335.5660
 EMAIL: civil-hawks@uiowa.edu



EDUCATIONAL, NOT FOR CONSTRUCTION

BRIDGE AND BIKEWAY

12TH ST. OVER WILLOW CREEK
 MASON CITY, IOWA

SHEET NAME

SHEET NO.

B1

W. WILLOW CREEK BRIDGE
STATION 28+42.18

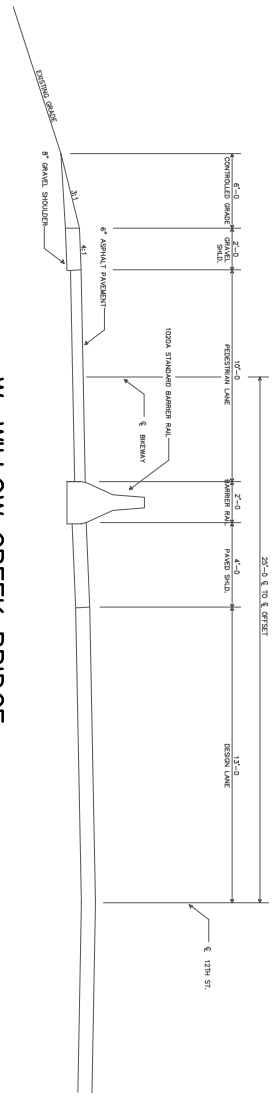

12TH ST. (TYP.)
STATION 68+10.00

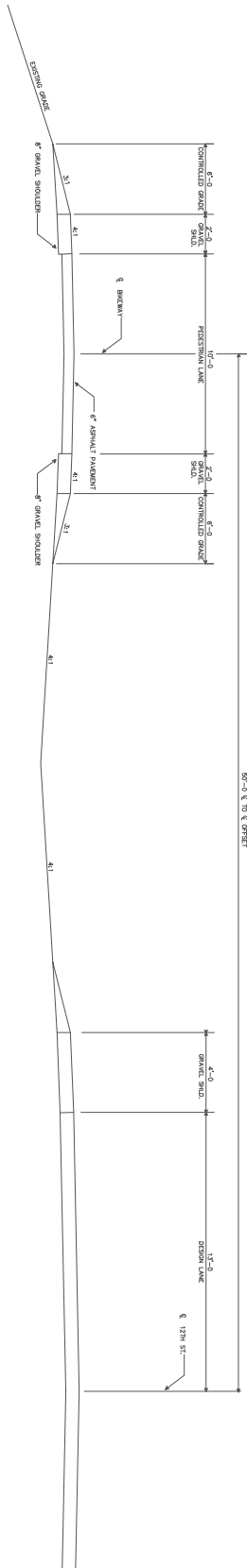

12TH ST.
STATION 68+10.00

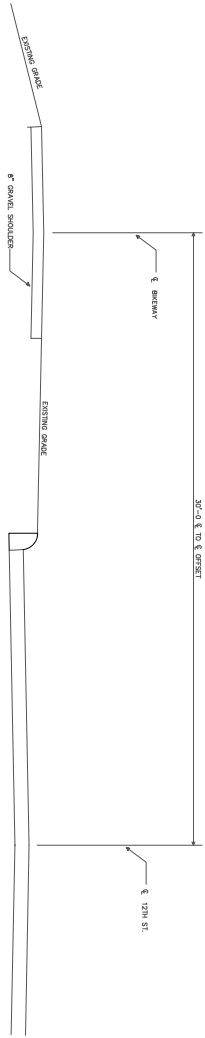

DESIGN FOR 0° SKEW
75'-0" x 40'-0"
BRIDGE AND BIKEWAY
 SINGLE SPAN BRIDGE
BIKEWAY CROSS-SECTIONS
 STATION 28+42.18 = CENTERLINE 12TH ST. BRIDGE
CERRO GORDO COUNTY
 MAY 2017
 CITY OF MASON CITY
 DESIGN SHEET NO. ___ OF ___ FILE NO. ___ DESIGN NO. ___

SHEET NO.
B2

BRIDGE AND BIKEWAY
 12TH ST. OVER WILLOW CREEK
 MASON CITY, IOWA



THE UNIVERSITY OF IOWA
CIVIL AND ENVIRONMENTAL ENGINEERING
 4105 SEAMANS CENTER FOR THE
 ENGINEERING ARTS AND SCIENCES
 103 S CAPITOL ST
 IOWA CITY, IOWA 52242
 PHONE: 319.335.5647
 FAX: 319.335.5660
 EMAIL: civil-hawks@uiowa.edu

PROJECT:	005
DATE :	5/1/2017
DRAWN BY:	ZRG
REVISION:	

TRAFFIC CONTROL PLAN

12TH ST. IS TO BE CLOSED BETWEEN THE TWO SECTIONS OF TAFT AVE. AND SHALL REMAIN CLOSED FOR THE DURATION OF THE PROJECT UNTIL THE PROPOSED BRIDGE IS COMPLETED

GENERAL NOTES:

ALL INCLUDED DESIGN SHEETS ARE PRELIMINARY AND FOR EDUCATIONAL PURPOSES ONLY. FUTURE DESIGN MUST BE APPROVED BY A LICENSED CIVIL ENGINEER.

THIS DESIGN IS FOR THE REPLACEMENT OF THE EXISTING 28'-0" x 28'-0" SINGLE SPAN STEEL BEAM BRIDGE WITH A 40'-0" x 75'-0" SINGLE SPAN HYBRID COMPOSITE BEAM BRIDGE AND THE EXTENSION OF THE LOCAL BIKE TRAIL SYSTEM IN MASON CITY, IOWA.

THE BRIDGE IS DESIGNED FOR HL-93 LOADING, PLUS 20 LBS. PER SQUARE FOOT OF FUTURE WEARING SURFACE AND A PEDESTRIAN LAKE LOAD.

FOUNDATION COMPONENTS OF THE BRIDGE ARE TO BE PRE-CAST TO DECREASE CONSTRUCTION TIME. THIS PROJECT INCLUDES A TIMELINE FOR RAPID BUILD CONSTRUCTION.

THESE BRIDGE PLANS LABEL ALL REINFORCING STEEL WITH ENGLISH NOTATION (5#4) IS 5/8" INCH DIAMETER BAR). ENGLISH REINFORCING STEEL RECEIVED IN THE FIELD MAY DISPLAY THE FOLLOWING "BAR DESIGNATION". THE "BAR DESIGNATION" IS THE STAMPED IMPRESSION ON THE REINFORCING BARS AND IS EQUIVALENT TO THE BAR DIAMETER IN MILLIMETERS

ENGLISH SIZE	3	4	5	6	7	8	9	10	11
BAR DESIGNATION	Q1	Q1	Q1	Q1	Q1	Q1	Q1	Q1	Q1

SEVERAL STANDARD DESIGN SHEETS ARE INCLUDED IN THIS PROJECT AND CAN BE FOUND ON THE IOWA DOT WEB PAGE. DESIGN SHEETS INCLUDED IN THIS PROJECT ARE:

- BR-201 (BRIDGE APPROACH)
- 1028A (SHARPER RAIL)
- 1029C (PEDESTRIAN RAIL)
- 1007D (PEDESTRIAN RAIL)

TOTAL ESTIMATED PROJECT QUANTITIES

ITEM NO.	ITEM CODE	ITEM	UNIT	QUANTITIES		NOTES
				ESTIMATED TOTAL	AS BUILT TOTAL	
1		STANDARD PAVEMENT CONCRETE	CY	289.6		
2		STRUCTURE PAVEMENT	CY	191.5		
4		EPOXY COATED REBAR	LESS	95,902		
5		STAINLESS STEEL BEAR	LESS	4,620		
6		STEEL PIPE HANDRAIL	LF	150		
7		HYBRID COMPOSITE BEAMS	LF	666		
8		HR STEEL PILES	LF	1104		
9		BRG. 18" BRP/PP	SF	350		
10		BRIDGE ENGINEERING FABRIC	CY	150		
11		BRIDGE BACKFILL MATERIAL	LF	79.0		
12		CHAIN LINK FENCE	UNIT	16		
13		TRAFFIC PASS	UNIT	6		
14		TRAFFIC SIGNAL MARK SIGNS	UNIT	6		
15		TRAFFIC SIGNAL SIGNS	CY	5,870		
16		PEDESTRIAN TRAIL GUF	CY	7,254		
17		PEDESTRIAN TRAIL FILL	CY	7,254		
18		36" CULVERT	UNIT	40		
19		18" CULVERT	UNIT	40		
20		8" CULVERT	UNIT	84		
21		GUARD RAIL END TERMINAL	UNIT	2		
22		CLASS B REEVENMENT	TONS	75.6		
23		CLASS 10 EXCAVATION	TONS	150		
24		BRIDGE REMOVAL	LUMP			
25		SAFETY CLOSURE	LUMP			
26		SEEDING	ACRE	50		
27		SEDIMENT FERTILIZATION	ACRE	900		
28		SILT FENCE	LF	800		
29		SEDIMENT CONTROL	LUMP			
30		CLEANING AND DRUBBING	ACRE	5		
31		GRANULAR SHOULDER	SF	240		
32		BANK SHARPING	SF	50		
33		PAVEMENT REMOVAL	LUMP			
34		PAINTED PAVEMENT	STA	4		
35		BRIDGE SOIL COMPACTION	SY	175		

DESIGN FOR 0° SKEW
75'-0" x 40'-0"
BRIDGE AND BIKEWAY
 SINGLE SPAN BRIDGE
GENERAL NOTES AND QUANTITIES
 STATION 28+42.18 = CENTERLINE 12TH ST. BRIDGE
CERRO GORDO COUNTY
 MAY 2017
 CITY OF MASON CITY

DESIGN SHEET NO. _____ OF _____ FILE NO. _____ DESIGN NO. _____

<p>SHEET NO. C1</p>	<p>BRIDGE AND BIKEWAY</p> <p>12TH ST. OVER WILLOW CREEK MASON CITY, IOWA</p>	 <p>THE UNIVERSITY OF IOWA CIVIL AND ENVIRONMENTAL ENGINEERING</p> <p>4105 SEAMANS CENTER FOR THE ENGINEERING ARTS AND SCIENCES 103 S CAPITOL ST IOWA CITY, IOWA 52242 PHONE: 319.335.5647 FAX: 319.335.5660 EMAIL: civil-hawks@iowa.edu</p>	<p>PROJECT: 005</p> <p>DATE : 5/1/2017</p> <p>DRAWN BY: ZRG</p> <p>REVISION:</p>
--------------------------------	---	---	--

EDUCATIONAL, NOT FOR CONSTRUCTION

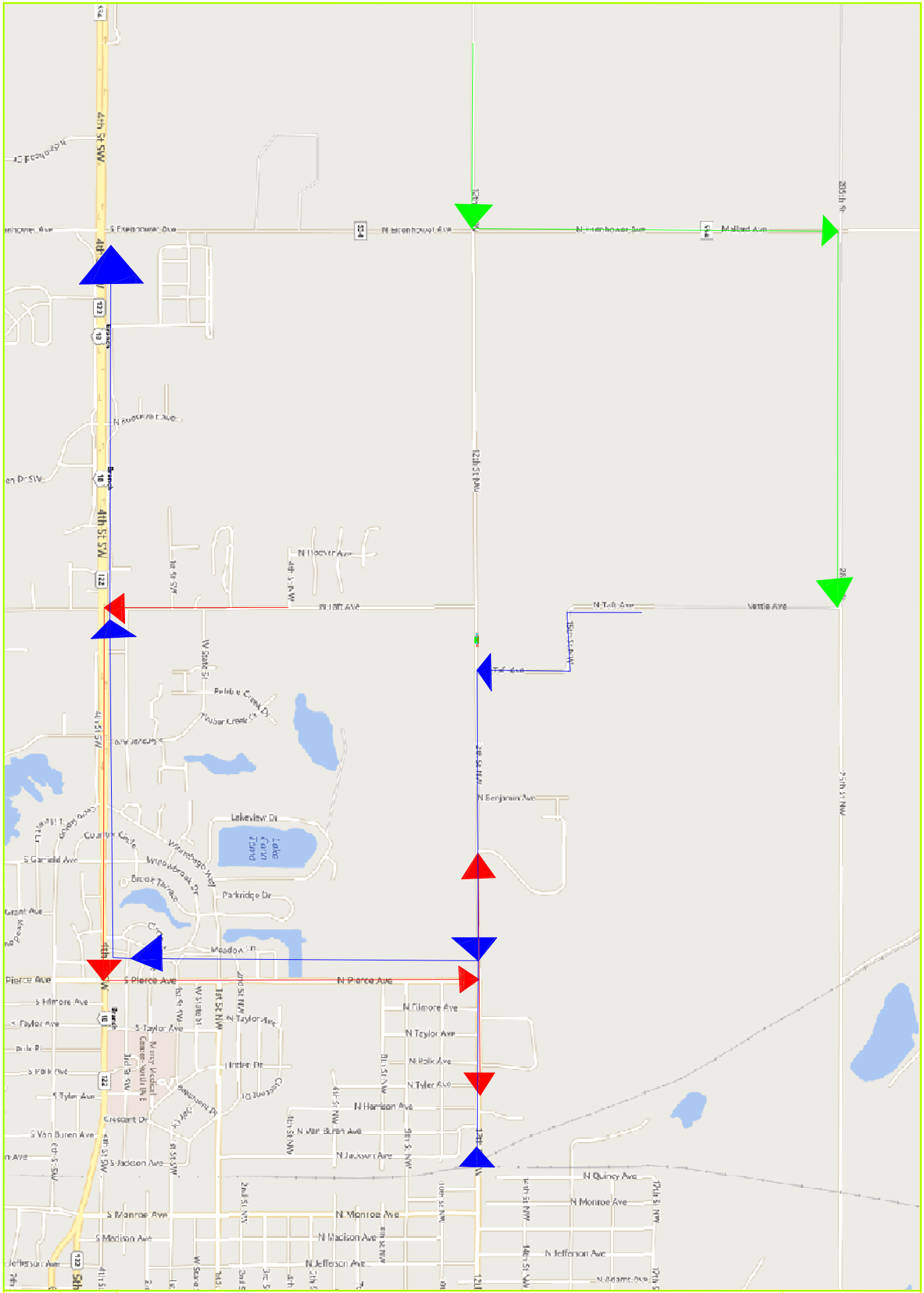

J1

SHEET NO.
SHEET NAME

BRIDGE AND BIKEWAY

N TAFT ST AND 12TH ST
MASON CITY, IA 50402

EDUCATIONAL UNIT FOR CONSTRUCTION



THE UNIVERSITY OF IOWA CIVIL AND ENVIRONMENTAL ENGINEERING

4105 SEAMANS CENTER FOR THE
ENGINEERING ARTS AND SCIENCES
103 S CAPITOL ST
IOWA CITY, IOWA 52242
PHONE: 319.335.5647
FAX: 319.335.5660
EMAIL: civil-hawks@uiowa.edu

PROJECT:	RFD-5
DATE :	4/25/17
DRAWN BY:	ATRK
REVISION:	

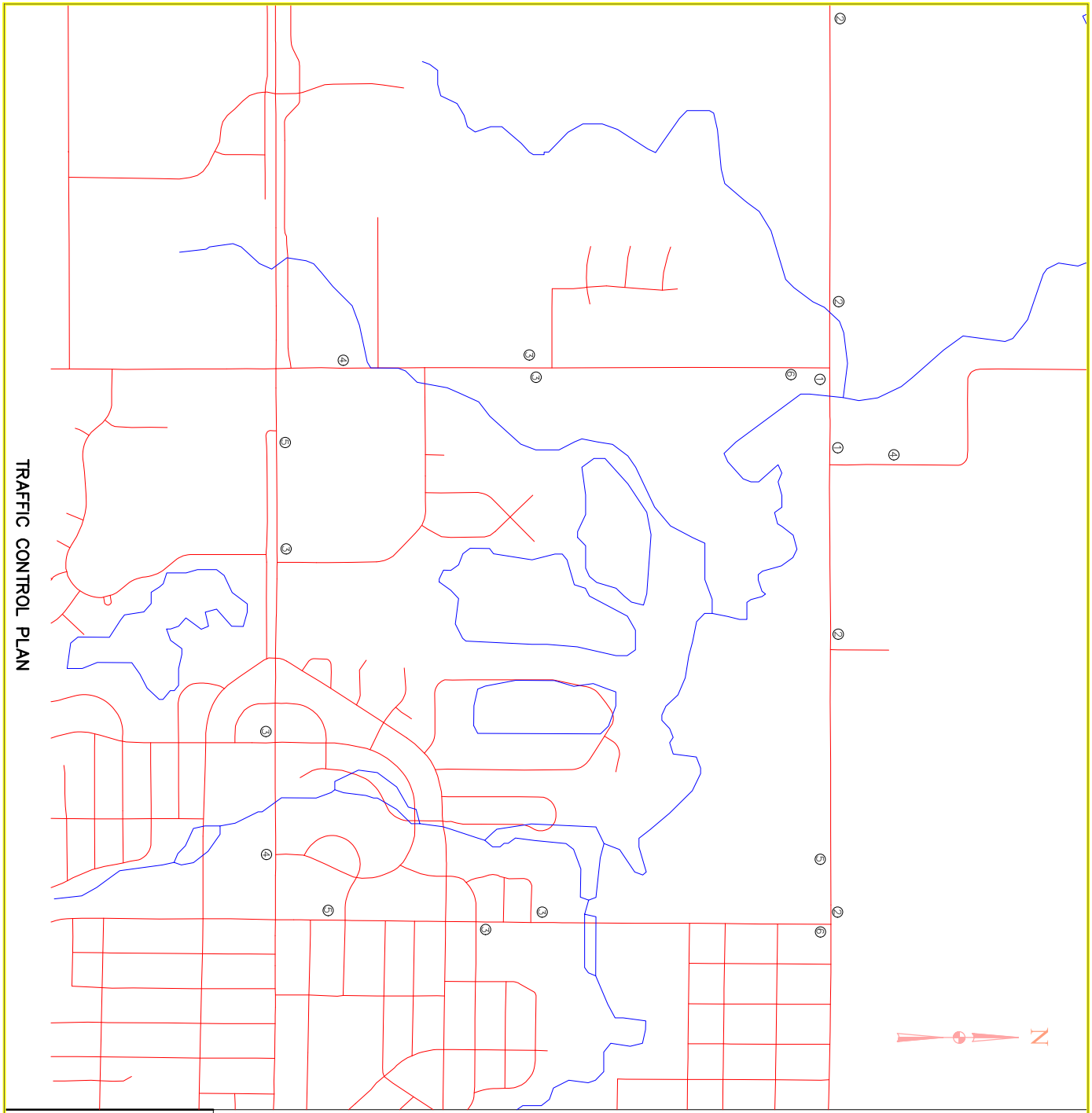

TRAFFIC CONTROL PLAN



SIGNAGE DETAILS:

- ① LIGHTED ROAD CLOSED SIGN AND ROAD CLOSURE BARRIERS
- ② ROAD CLOSED AHEAD SIGN
- ③ 12TH ST. DETOUR
- ④ 12TH ST. DETOUR-TURN LEFT
- ⑤ 12TH ST. DETOUR-TURN RIGHT
- ⑥ END DETOUR

TRAFFIC NOTES:

ALL SIGNAGE IS TO BE PLACED AT LEAST 24 HOURS BEFORE CLOSURE OF THE BRIDGE AND IS TO REMAIN FOR THE DURATION OF THE PROJECT. SIGNS SHALL BE PROVIDED BY THE CONTRACTOR AND MUST BE PLACED IN ACCORDANCE WITH IOWA DOT TRAFFIC REQUIREMENTS.

DESIGN FOR 0° SKEW
75'-0" x 40'-0"
 BRIDGE AND BIKEWAY
 SINGLE SPAN BRIDGE
TRAFFIC CONTROL PLAN
 STATION 28+42.18 = CENTERLINE 12TH ST. BRIDGE
CERRO GORDO COUNTY
 MAY 2017
 CITY OF MASON CITY
 DESIGN SHEET NO. _____ OF _____ FILE NO. _____ DESIGN NO. _____

<p>BRIDGE AND BIKEWAY</p> <p>12TH ST. OVER WILLOW CREEK MASON CITY, IOWA</p>		<p>THE UNIVERSITY OF IOWA CIVIL AND ENVIRONMENTAL ENGINEERING 4105 SEAMANS CENTER FOR THE ENGINEERING ARTS AND SCIENCES 103 S CAPITOL ST IOWA CITY, IOWA 52242 PHONE: 319.335.5647 FAX: 319.335.5660 EMAIL: civil-hawks@uiowa.edu</p>	<p>PROJECT: 005</p> <p>DATE: 5/1/2017</p> <p>DRAWN BY: ZRG</p> <p>REVISION:</p>
<p>SHEET NO.</p> <p>J2</p>	<p>SHEET NAME</p>	<p>EDUCATIONAL, NOT FOR CONSTRUCTION</p>	

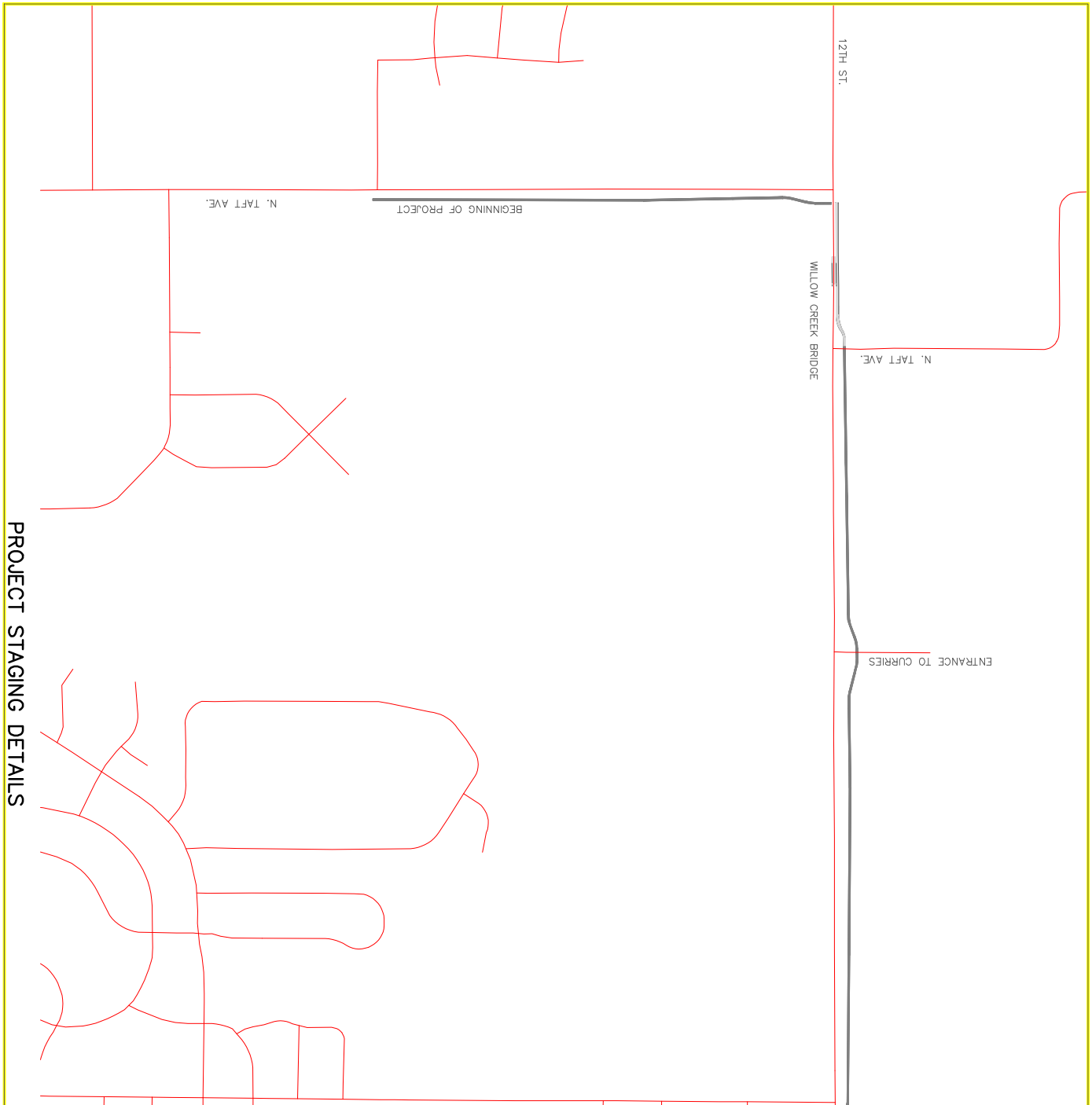

PROJECT STAGING DETAILS

- STAGE 1: BRIDGE REMOVAL, BRIDGE CONSTRUCTION, APPROACH SLAB, SECTION 2 OF BIKEWAY FROM TAFT AVE. TO TAFT AVE. ON 12TH ST.
- STAGE 2: SECTIONS 1 OF BIKEWAY FROM 4TH ST TO 12TH ST. ON TAFT AVE. AND SECTION 2 FROM TAFT AVE. (E) TO HARRISON AVE.

STAGING NOTES NOTES:
 EACH STAGE MAY BE DONE AT THE SAME TIME OR INDEPENDENTLY BASED ON THE TIMING AND NEEDS OF MASON CITY. SECTION 2 OF THE BIKEWAY IS INCLUDED IN THE FIRST STAGE OF THE PROJECT TO MINIMIZE IMPACTS TO 12TH STREET TRAFFIC.

DESIGN FOR 0° SKEW
75'-0" x 40'-0"
BRIDGE AND BIKEWAY
 SINGLE SPAN BRIDGE
STAGING DETAILS
 STATION 28+42.18 = CENTERLINE 12TH ST. BRIDGE
CERRO GORDO COUNTY
 MAY 2017
 CITY OF MASON CITY

DESIGN SHEET NO. _____ OF _____ FILE NO. _____ DESIGN NO. _____

	<p>THE UNIVERSITY OF IOWA CIVIL AND ENVIRONMENTAL ENGINEERING</p> <p>4105 SEAMANS CENTER FOR THE ENGINEERING ARTS AND SCIENCES 103 S CAPITOL ST IOWA CITY, IOWA 52242 PHONE: 319.335.5647 FAX: 319.335.5660 EMAIL: civil-hawks@uiowa.edu</p>	<p>PROJECT: 005</p> <p>DATE : 5/1/2017</p> <p>DRAWN BY: ZRG</p> <p>REVISION:</p>
<p>BRIDGE AND BIKEWAY</p> <p>12TH ST. OVER WILLOW CREEK MASON CITY, IOWA</p>	<p>EDUCATIONAL - NOT FOR CONSTRUCTION</p>	
<p>SHEET NO.</p> <p>J3</p>	<p>SHEET NAME</p>	

INTAKES AND UTILITY ACCESSSES

Storm Sewer

Pipes

No.	Location Station and Offset	Type or Standard Road Plan	Form		Extension Length**	Notes	Line Number	Inlet/Utility Access No.		CLASS D'	Pipe Size		Bid Length FT	Design Length FT	Slope %	Connected Pipe Joint (DR-121) Type	Inlet Elevation	Flow Lines			Pipe Profile Sheet No.	Notes
			Grade Elev.	Bottom Well Elev.				From	To		In	FT						Outlet Elevation	Other Elevation			
IN-1	00+47.98, 9.16 LT	DR-203						IN-1	IN-2		18	36.6	32.6	3.83			1149.5	1148.25				
IN-2	00+52.97, 23.07 RT	DR-203						IN-3	IN-4		36	41.3	37.3	0.73			1125	1124.73				
IN-3	25+69.4, 6.67 LT	DR-203						IN-6	IN-5		8	23.5	19.5	0.05			1130	1129.99				
IN-4	26+03.29, 30.25 RT	DR-203						IN-8	IN-7		8	19.9	15.9	0.05			1130	1129.99				
IN-5	63+83.86, 9.73 LT	DR-203																				
IN-6	63+91.95, 8.45 LT	DR-203																				
IN-7	64+51.32, 7.99 RT	DR-203																				
IN-8	64+55.25, 7.25 LT	DR-203																				

PROJECT: RFD-5
DATE: 4/25/17
DRAWN BY: ATRK
REVISION:

THE UNIVERSITY OF IOWA
CIVIL AND ENVIRONMENTAL ENGINEERING
4105 SEAMANS CENTER FOR THE
ENGINEERING ARTS AND SCIENCES
103 S CAPITOL ST
IOWA CITY, IOWA 52242
PHONE: 319 336 6267



BRIDGE AND BIKEWAY
N TAFT ST AND 12TH ST

SHEET NAME

SHEET NO.

M1

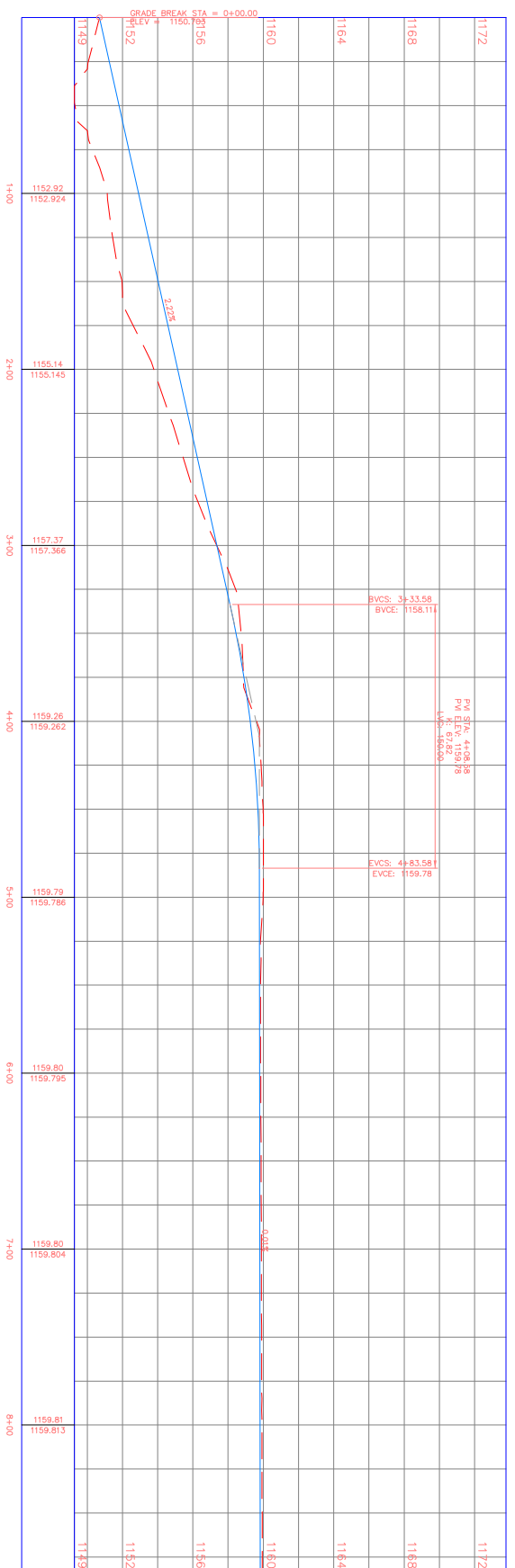
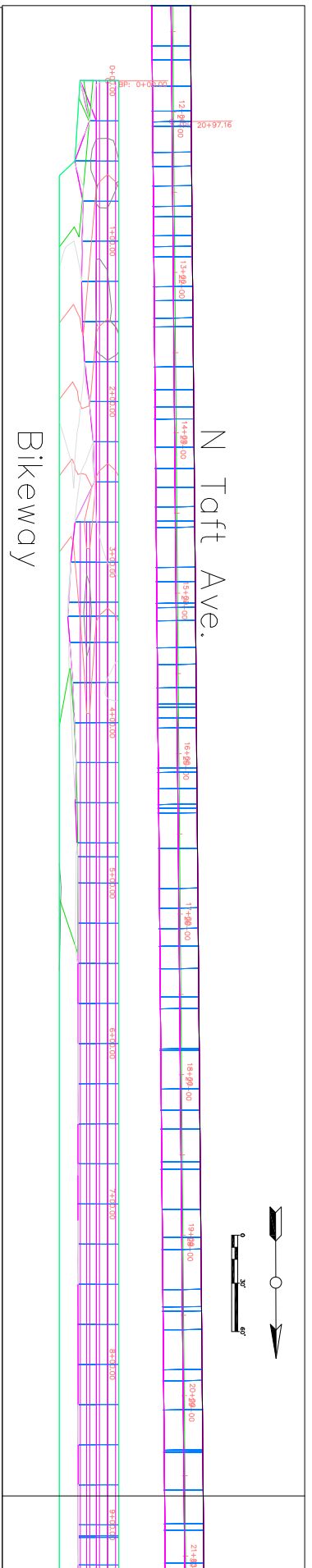

Section 1 PROFILE

SHEET NO.
S.1

SHEET NAME

BRIDGE AND BIKEWAY

N TAFT ST AND 12TH ST
MASON CITY, IA 50402

EDUCATIONAL - NOT FOR CONSTRUCTION



THE UNIVERSITY OF IOWA
CIVIL AND ENVIRONMENTAL ENGINEERING
4105 SEAMANS CENTER FOR THE ENGINEERING ARTS AND SCIENCES
103 S. CAPITOL ST
IOWA CITY, IOWA 52242
PHONE: 319.335.5647
FAX: 319.335.5660
EMAIL: civil-hawks@uiowa.edu

PROJECT:	RFD-5
DATE :	4/25/17
DRAWN BY:	ATRK
REVISION:	

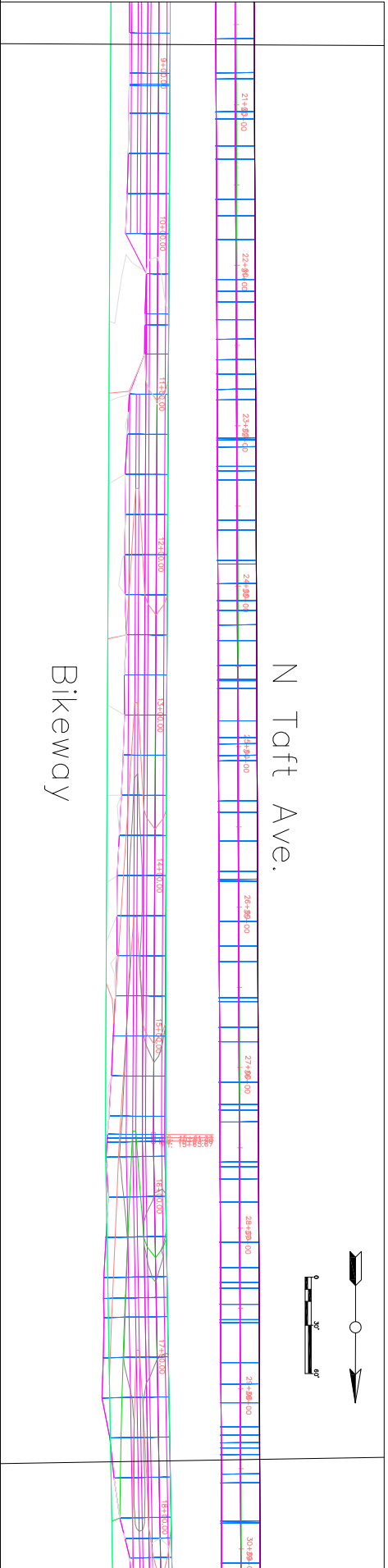

Bikeway

N Taft Ave.

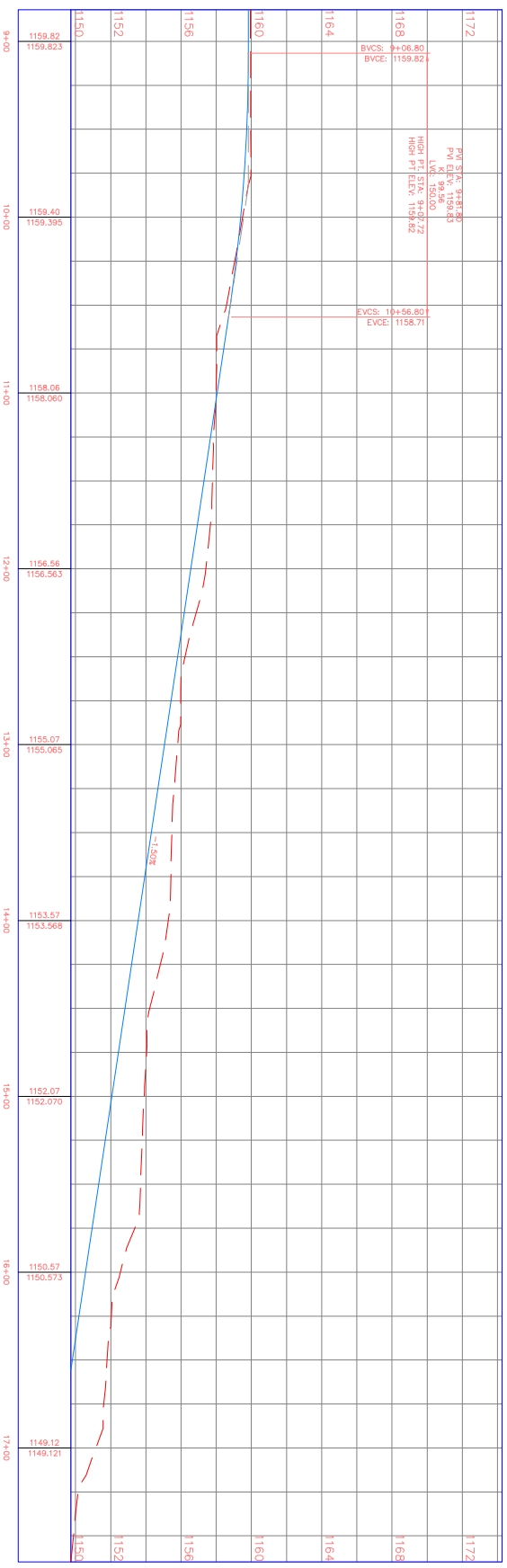

Section 1 PROFILE

PVI STA: 9+81.81
 PVI ELEV: 1159.83
 LVI: 150.00
 HIGH PT. STA: 9+07.72
 HIGH PT. ELEV: 1159.82

SVCS: 10+56.80
 EVCE: 1158.71

PROJECT:	RFD-5
DATE :	4/25/17
DRAWN BY:	ATRK
REVISION:	

THE UNIVERSITY OF IOWA
CIVIL AND ENVIRONMENTAL ENGINEERING
 4105 SEAMANS CENTER FOR THE
 ENGINEERING ARTS AND SCIENCES
 103 S. CAPITOL ST
 IOWA CITY, IOWA 52242
 PHONE: 319.335.5647
 FAX: 319.335.5660
 EMAIL: civil-hawks@uiowa.edu



EDUCATIONAL NOT FOR CONSTRUCTION

BRIDGE AND BIKEWAY

N TAFT ST AND 12TH ST
MASON CITY, IA 50402

SHEET NAME

SHEET NO.

S2

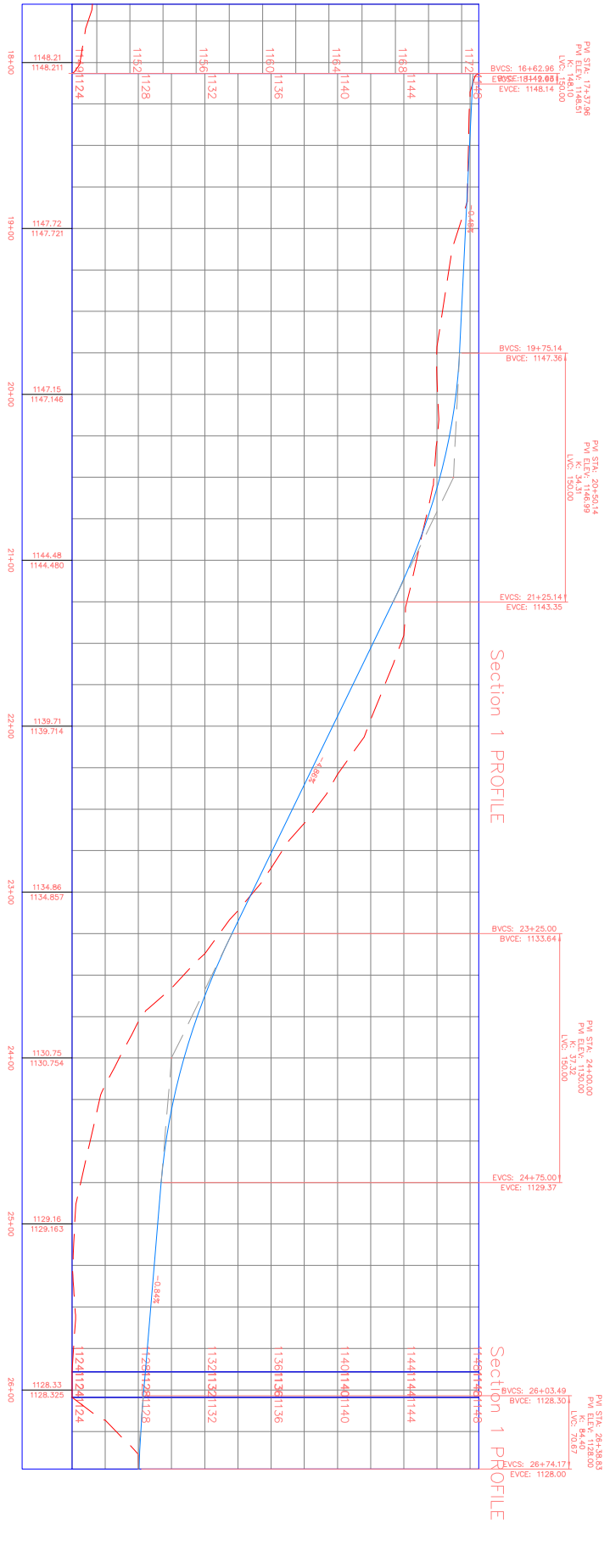
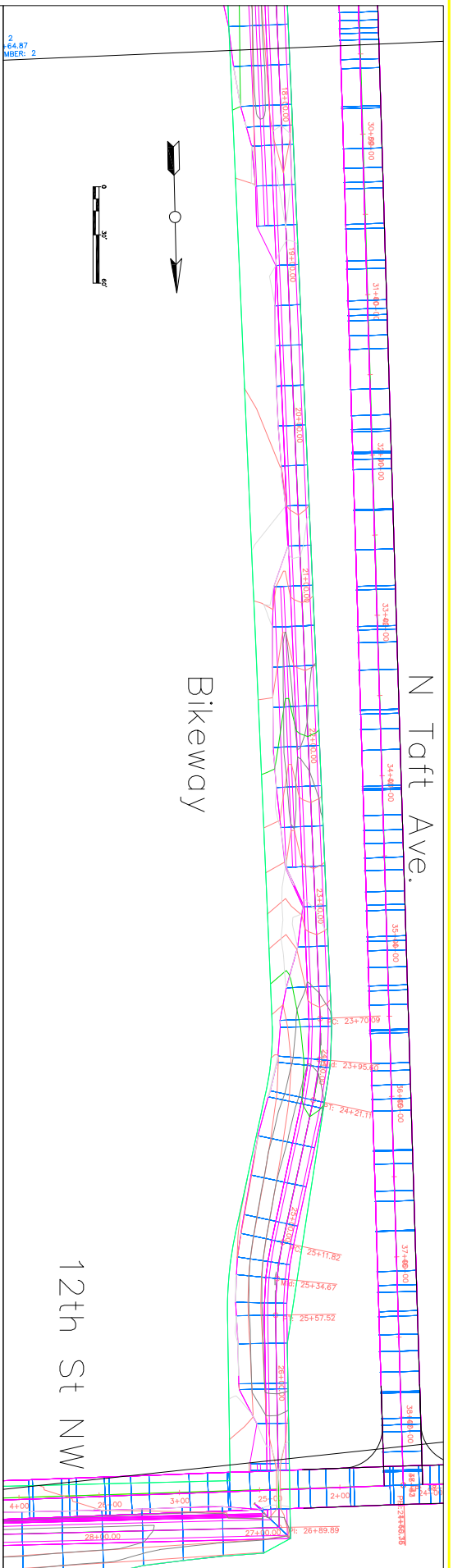

PROJECT: RFD-5
 DATE: 4/25/17
 DRAWN BY: ATRK
 REVISION:

THE UNIVERSITY OF IOWA
CIVIL AND ENVIRONMENTAL ENGINEERING
 4105 SEAMANS CENTER FOR THE
 ENGINEERING ARTS AND SCIENCES
 103 S CAPITOL ST
 IOWA CITY, IOWA 52242
 PHONE: 319.335.5647
 FAX: 319.335.5660
 EMAIL: civil-hawks@uiowa.edu



EDUCATIONAL - NOT FOR CONSTRUCTION

BRIDGE AND BIKEWAY

N TAFT ST AND 12TH ST
 MASON CITY, IA 50402

SHEET NAME

SHEET NO.

S3

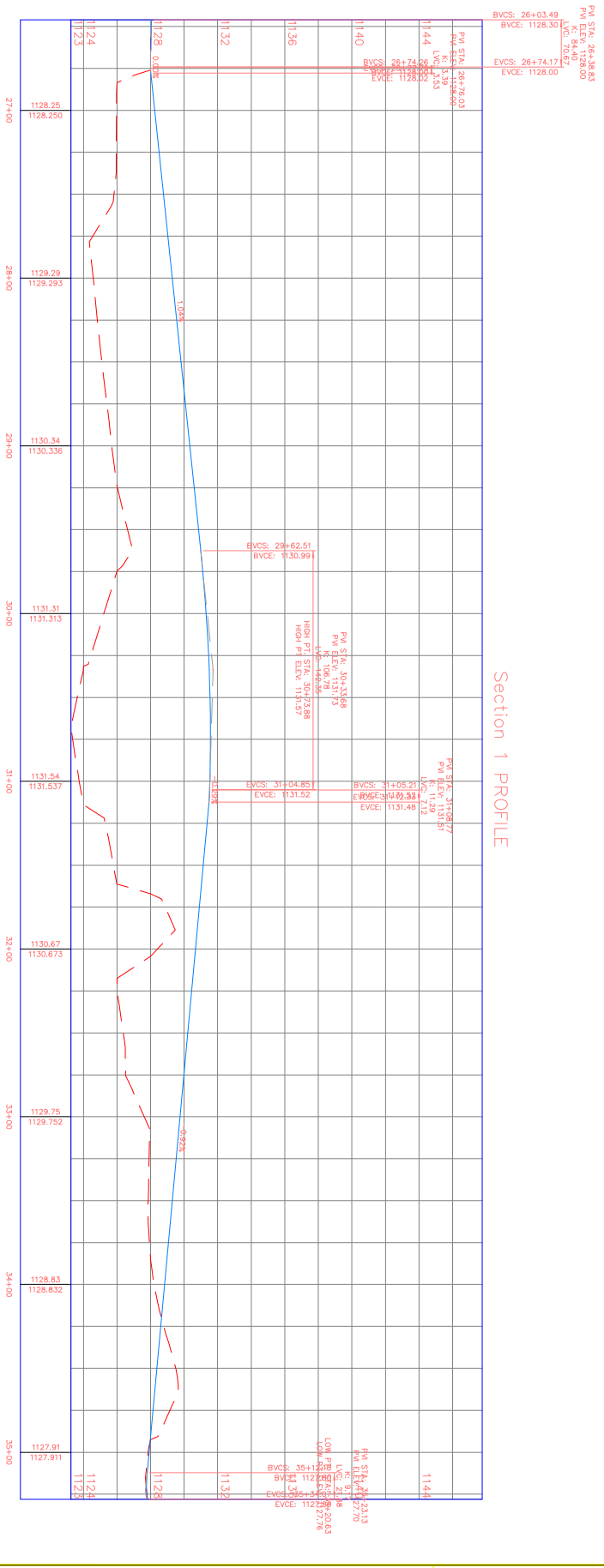

N Taft Ave.

Willow Creek Bridge
12th St. NW

Bikeway

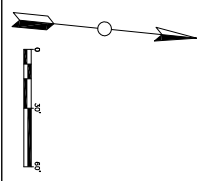

Section 1 PROFILE

Alignment
Northern
Offset = 0.00
Right of Way
Boundary
1:40
SHEET
35+56.21
34+70.81
34+59.44
34+49.00
34+38.50
34+28.00
34+17.50
34+07.00
33+96.50
33+86.00
33+75.50
33+65.00
33+54.50
33+44.00
33+33.50
33+23.00
33+12.50
33+02.00
32+91.50
32+81.00
32+70.50
32+60.00
32+49.50
32+39.00
32+28.50
32+18.00
32+07.50
31+97.00
31+86.50
31+76.00
31+65.50
31+55.00
31+44.50
31+34.00
31+23.50
31+13.00
31+02.50
30+92.00
30+81.50
30+71.00
30+60.50
30+50.00
30+39.50
30+29.00
30+18.50
30+08.00
29+97.50
29+87.00
29+76.50
29+66.00
29+55.50
29+45.00
29+34.50
29+24.00
29+13.50
29+03.00
28+92.50
28+82.00
28+71.50
28+61.00
28+50.50
28+40.00
28+29.50
28+19.00
28+08.50
27+98.00
27+87.50
27+77.00
27+66.50
27+56.00
27+45.50
27+35.00
27+24.50
27+14.00
27+03.50
26+93.00
26+82.50
26+72.00
26+61.50
26+51.00
26+40.50
26+30.00
26+19.50
26+09.00
25+98.50
25+88.00
25+77.50
25+67.00
25+56.50
25+46.00
25+35.50
25+25.00
25+14.50
25+04.00
24+93.50
24+83.00
24+72.50
24+62.00
24+51.50
24+41.00
24+30.50
24+20.00
24+09.50
23+99.00
23+88.50
23+78.00
23+67.50
23+57.00
23+46.50
23+36.00
23+25.50
23+15.00
23+04.50
22+94.00
22+83.50
22+73.00
22+62.50
22+52.00
22+41.50
22+31.00
22+20.50
22+10.00
21+99.50
21+89.00
21+78.50
21+68.00
21+57.50
21+47.00
21+36.50
21+26.00
21+15.50
21+05.00
20+94.50
20+84.00
20+73.50
20+63.00
20+52.50
20+42.00
20+31.50
20+21.00
20+10.50
20+00.00
19+89.50
19+79.00
19+68.50
19+58.00
19+47.50
19+37.00
19+26.50
19+16.00
19+05.50
18+95.00
18+84.50
18+74.00
18+63.50
18+53.00
18+42.50
18+32.00
18+21.50
18+11.00
18+00.50
17+90.00
17+79.50
17+69.00
17+58.50
17+48.00
17+37.50
17+27.00
17+16.50
17+06.00
16+95.50
16+85.00
16+74.50
16+64.00
16+53.50
16+43.00
16+32.50
16+22.00
16+11.50
16+01.00
15+90.50
15+80.00
15+69.50
15+59.00
15+48.50
15+38.00
15+27.50
15+17.00
15+06.50
14+96.00
14+85.50
14+75.00
14+64.50
14+54.00
14+43.50
14+33.00
14+22.50
14+12.00
14+01.50
13+91.00
13+80.50
13+70.00
13+59.50
13+49.00
13+38.50
13+28.00
13+17.50
13+07.00
12+96.50
12+86.00
12+75.50
12+65.00
12+54.50
12+44.00
12+33.50
12+23.00
12+12.50
12+02.00
11+91.50
11+81.00
11+70.50
11+60.00
11+49.50
11+39.00
11+28.50
11+18.00
11+07.50
10+97.00
10+86.50
10+76.00
10+65.50
10+55.00
10+44.50
10+34.00
10+23.50
10+13.00
10+02.50
9+92.00
9+81.50
9+71.00
9+60.50
9+50.00
9+39.50
9+29.00
9+18.50
9+08.00
8+97.50
8+87.00
8+76.50
8+66.00
8+55.50
8+45.00
8+34.50
8+24.00
8+13.50
8+03.00
7+92.50
7+82.00
7+71.50
7+61.00
7+50.50
7+40.00
7+29.50
7+19.00
7+08.50
6+98.00
6+87.50
6+77.00
6+66.50
6+56.00
6+45.50
6+35.00
6+24.50
6+14.00
6+03.50
5+93.00
5+82.50
5+72.00
5+61.50
5+51.00
5+40.50
5+30.00
5+19.50
5+09.00
4+98.50
4+88.00
4+77.50
4+67.00
4+56.50
4+46.00
4+35.50
4+25.00
4+14.50
4+04.00
3+93.50
3+83.00
3+72.50
3+62.00
3+51.50
3+41.00
3+30.50
3+20.00
3+09.50
2+99.00
2+88.50
2+78.00
2+67.50
2+57.00
2+46.50
2+36.00
2+25.50
2+15.00
2+04.50
1+94.00
1+83.50
1+73.00
1+62.50
1+52.00
1+41.50
1+31.00
1+20.50
1+10.00
1+00.00
0+89.50
0+79.00
0+68.50
0+58.00
0+47.50
0+37.00
0+26.50
0+16.00
0+05.50
0+00.00

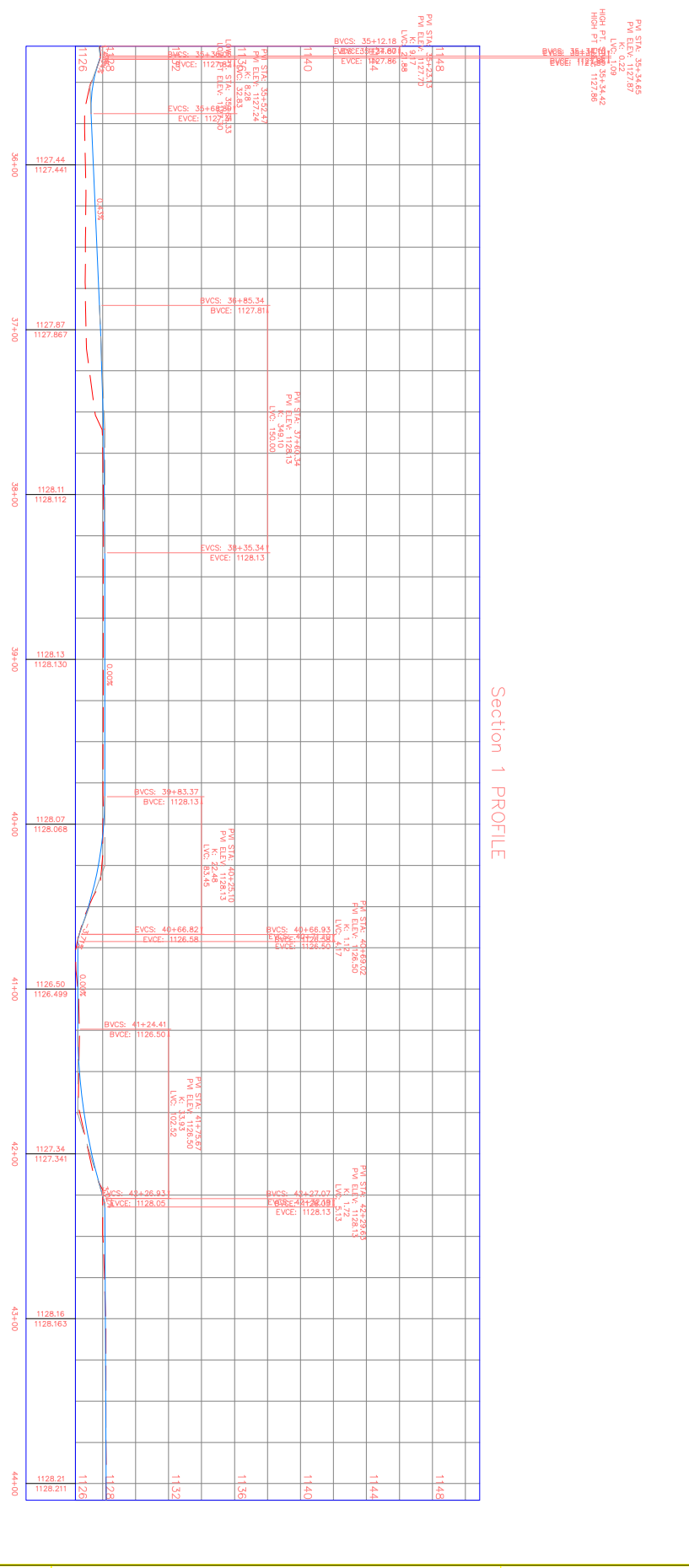
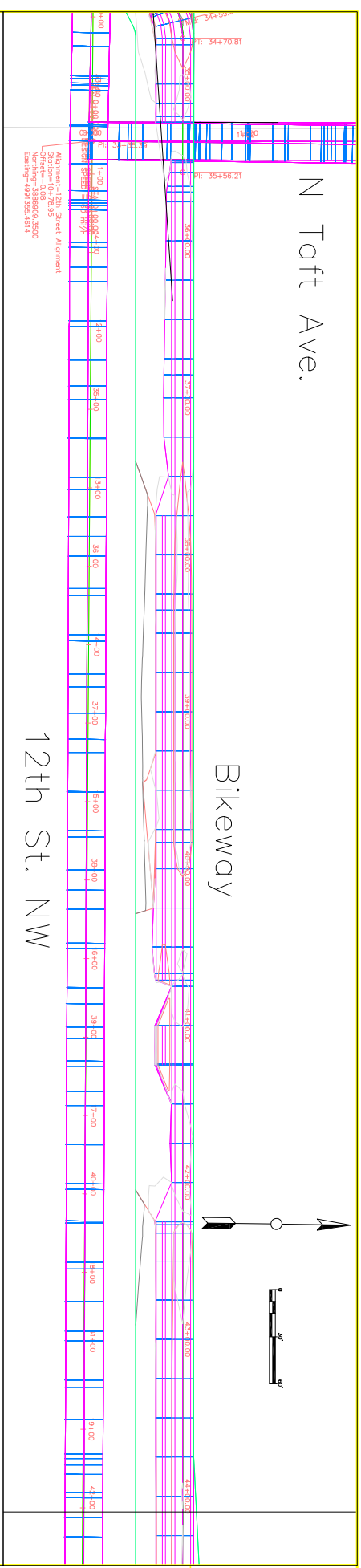

Section 1 PROFILE

<p>BRIDGE AND BIKEWAY</p> <p>N TAFT ST AND 12TH ST MASON CITY, IA 50402</p>	<p>THE UNIVERSITY OF IOWA CIVIL AND ENVIRONMENTAL ENGINEERING</p> <p>4105 SEAMANS CENTER FOR THE ENGINEERING ARTS AND SCIENCES 103 S. CAPITOL ST IOWA CITY, IOWA 52242 PHONE: 319.335.5647 FAX: 319.335.5660 EMAIL: civil-hawks@uiowa.edu</p>	<p>PROJECT: RFD-5</p> <p>DATE: 4/25/17</p> <p>DRAWN BY: ATRK</p> <p>REVISION:</p>
<p>SHEET NO.</p> <p>S5</p>	<p>SHEET NAME</p>	<p>EDUCATIONAL - NOT FOR CONSTRUCTION</p>

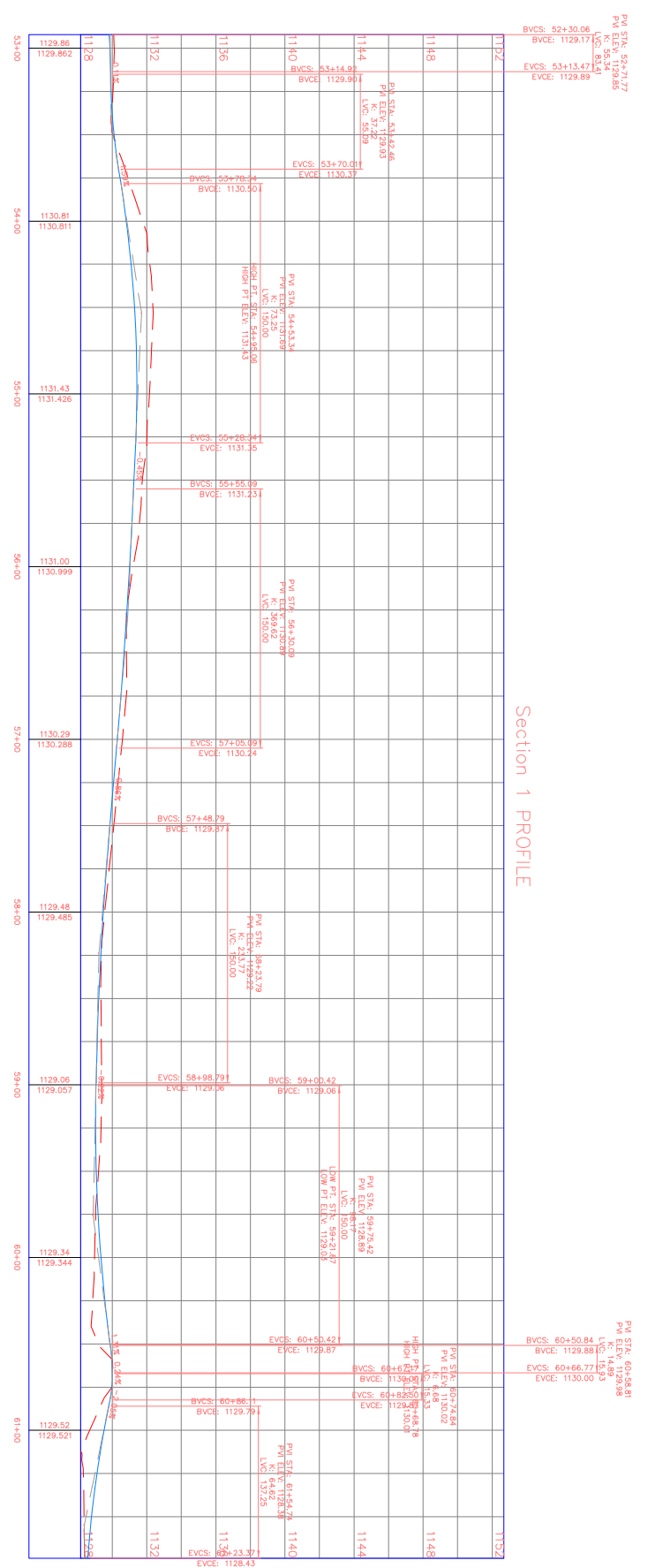
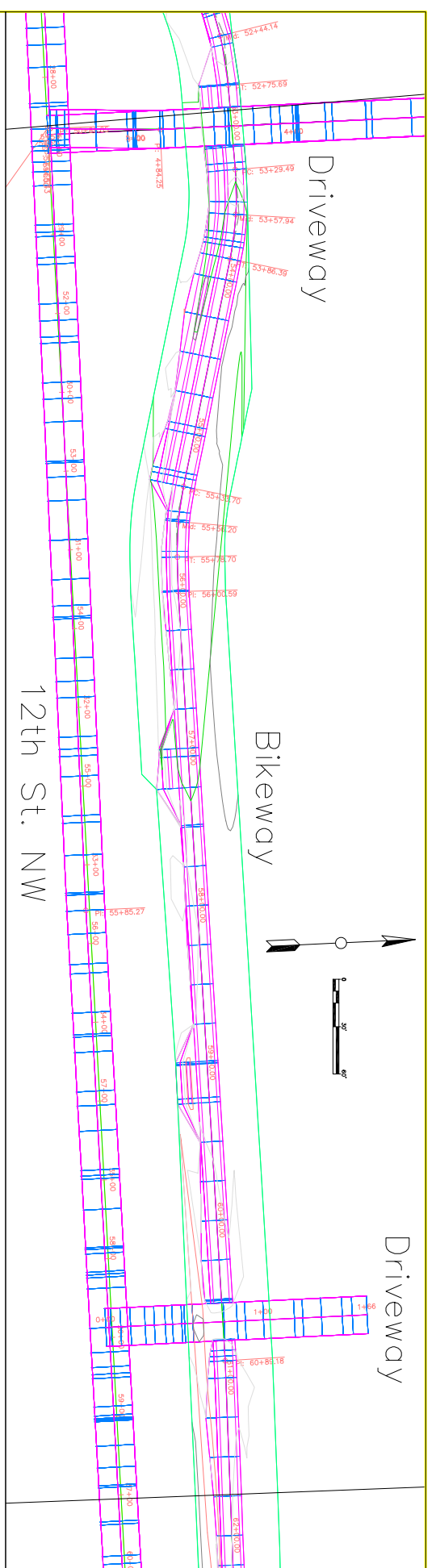

Section 1 PROFILE

12th St. NW

Driveway

Bikeway

Driveway

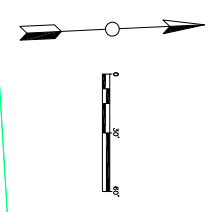

BRIDGE AND BIKEWAY

N TAFT ST AND 12TH ST
MASON CITY, IA 50402



THE UNIVERSITY OF IOWA
CIVIL AND ENVIRONMENTAL ENGINEERING

4105 SEAMANS CENTER FOR THE
ENGINEERING ARTS AND SCIENCES
103 S CAPITOL ST
IOWA CITY, IOWA 52242
PHONE: 319.335.5647
FAX: 319.335.5660
EMAIL: civil-hawks@uiowa.edu

PROJECT:	RFD-5
DATE :	4/25/17
DRAWN BY:	ATRK
REVISION:	

SHEET NAME

SHEET NO.

S7

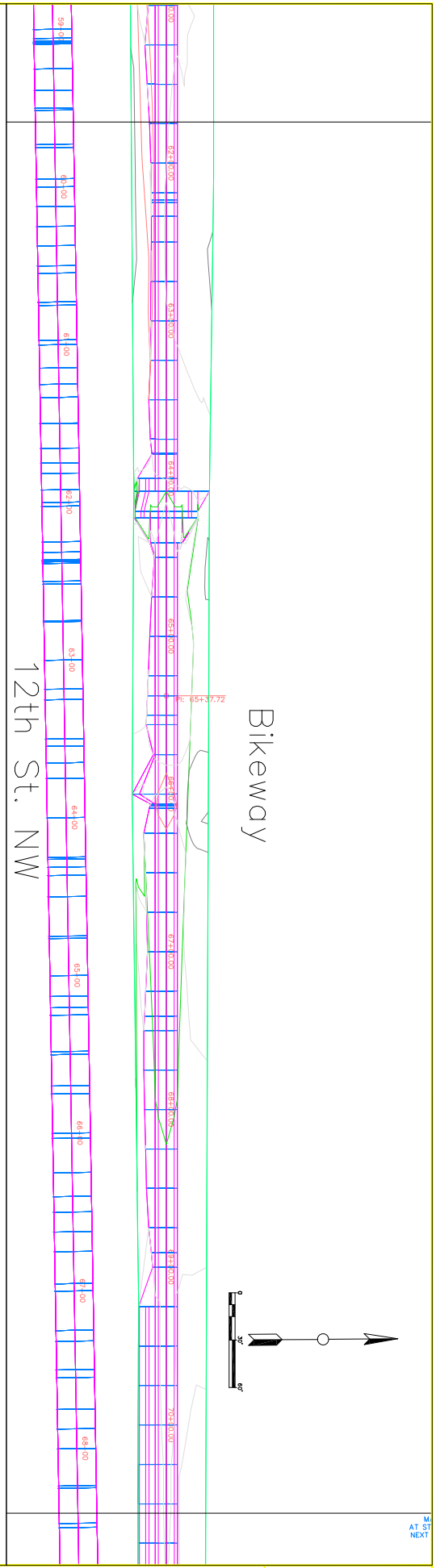

Bikeway

12th St. NW

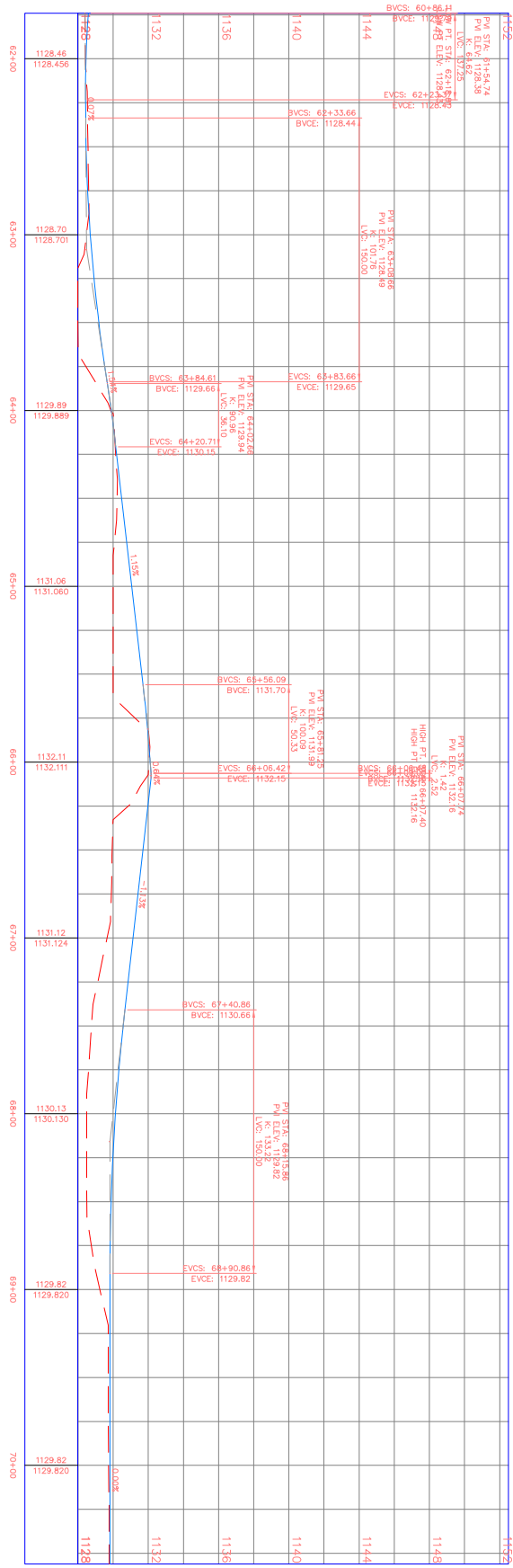
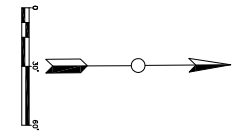

Section 1 PROFILE

AT 15 NEXT

SHEET NO.
S8

SHEET NAME

BRIDGE AND BIKEWAY

N TAFT ST AND 12TH ST
MASON CITY, IA 50402

EDUCATIONAL, NOT FOR CONSTRUCTION



THE UNIVERSITY OF IOWA
CIVIL AND ENVIRONMENTAL ENGINEERING

4105 SEAMANS CENTER FOR THE
ENGINEERING ARTS AND SCIENCES
103 S. CAPITOL ST
IOWA CITY, IOWA 52242
PHONE: 319.335.5647
FAX: 319.335.5660
EMAIL: civil-hawks@uiowa.edu

PROJECT:	RFD-5
DATE :	4/25/17
DRAWN BY:	ATRK
REVISION:	

Bikeway

12th St. NW

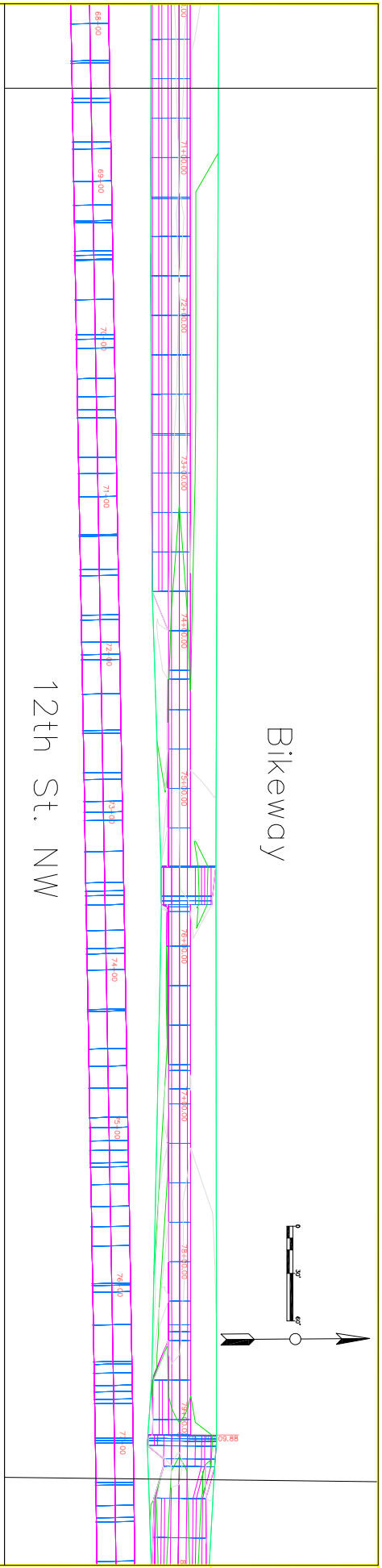
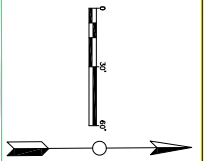

Section 1 PROFILE

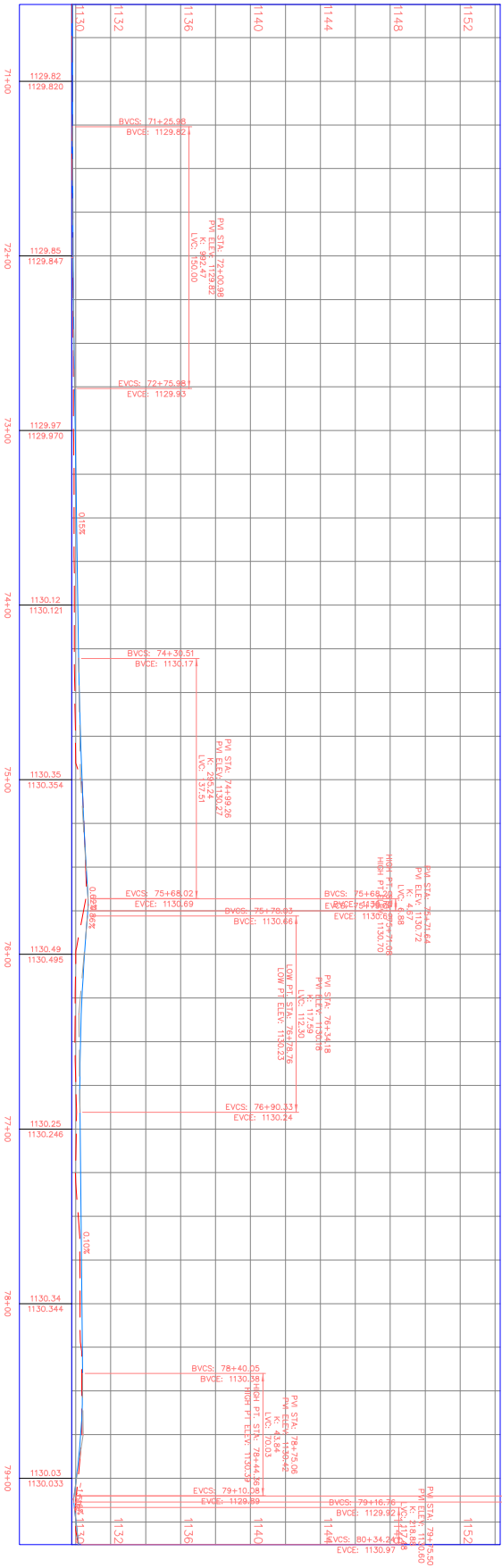

PVI STA: 79+11.92
 PVI ELEV: 1130.87
 LOW PT. STA: 79+11.92
 LOW PT. ELEV: 1130.87
 HIGH PT. STA: 79+11.92
 HIGH PT. ELEV: 1130.87
 SLOPE: 0.00%

PROJECT:	RFD-5
DATE:	4/25/17
DRAWN BY:	ATRK
REVISION:	

THE UNIVERSITY OF IOWA
CIVIL AND ENVIRONMENTAL ENGINEERING
 4105 SEAMANS CENTER FOR THE
 ENGINEERING ARTS AND SCIENCES
 103 S. CAPITOL ST
 IOWA CITY, IOWA 52242
 PHONE: 319.335.5647
 FAX: 319.335.5660
 EMAIL: civil-hawks@uiowa.edu



EDUCATIONAL - NOT FOR CONSTRUCTION

BRIDGE AND BIKEWAY

N TAFT ST AND 12TH ST
 MASON CITY, IA 50402

SHEET NAME

SHEET NO.

S9

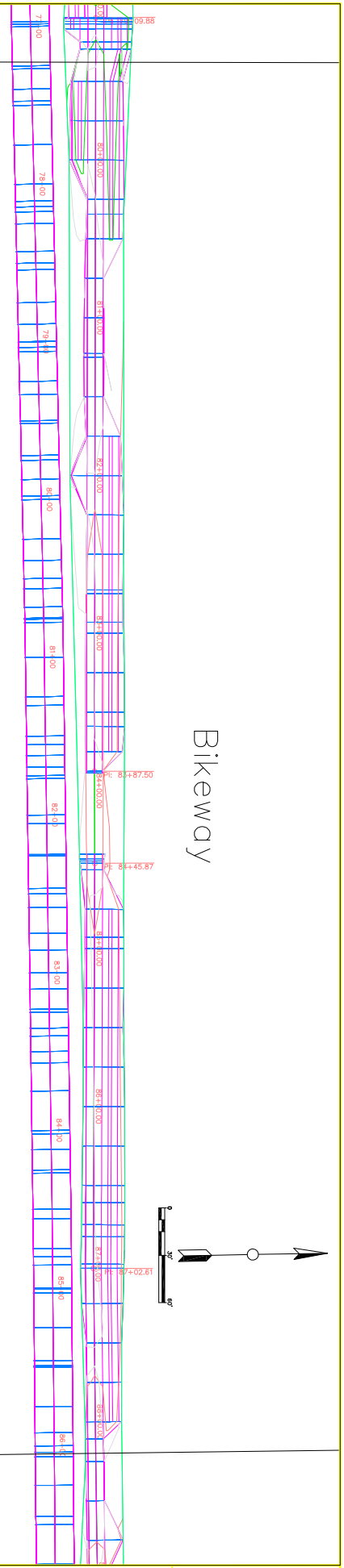

Bikeway

12th St. NW

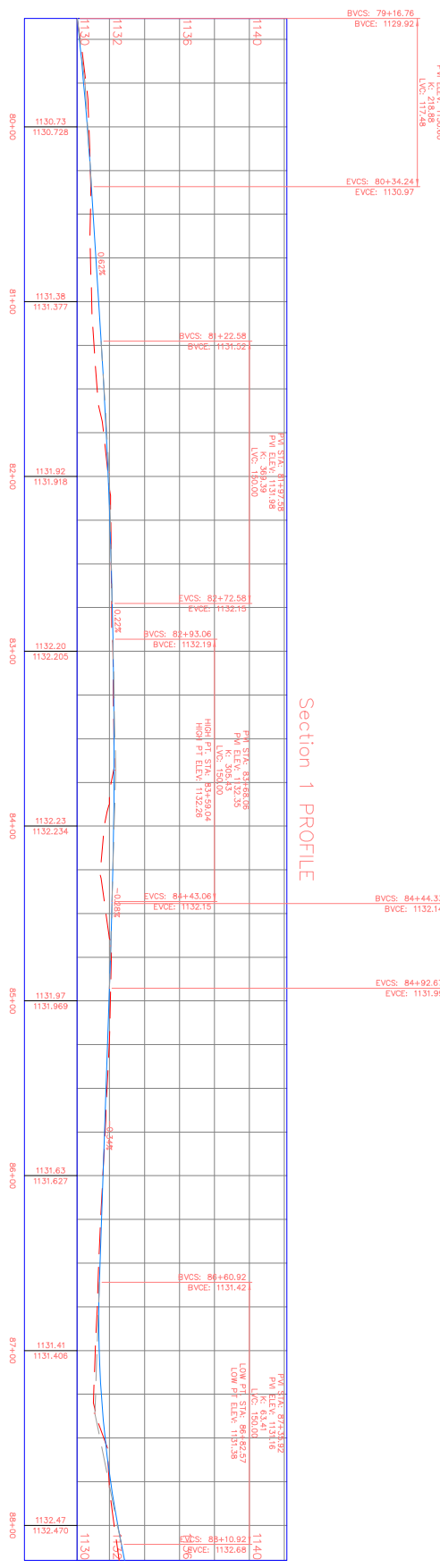

Section 1 PROFILE

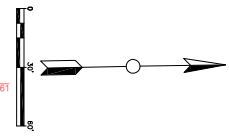

SHEET NO.
S10

SHEET NAME

BRIDGE AND BIKEWAY

N TAFT ST AND 12TH ST
MASON CITY, IA 50402

EDUCATIONAL, NOT FOR CONSTRUCTION



THE UNIVERSITY OF IOWA
CIVIL AND ENVIRONMENTAL ENGINEERING
4105 SEAMANS CENTER FOR THE
ENGINEERING ARTS AND SCIENCES
103 S. CAPITOL ST
IOWA CITY, IOWA 52242
PHONE: 319.335.5647
FAX: 319.335.5660
EMAIL: civil-hawks@uiowa.edu

PROJECT:	RFD-5
DATE :	4/25/17
DRAWN BY:	ATRK
REVISION:	

Bikeway

12th St. NW

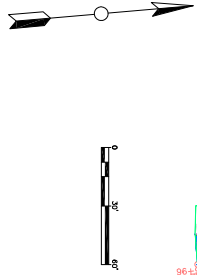
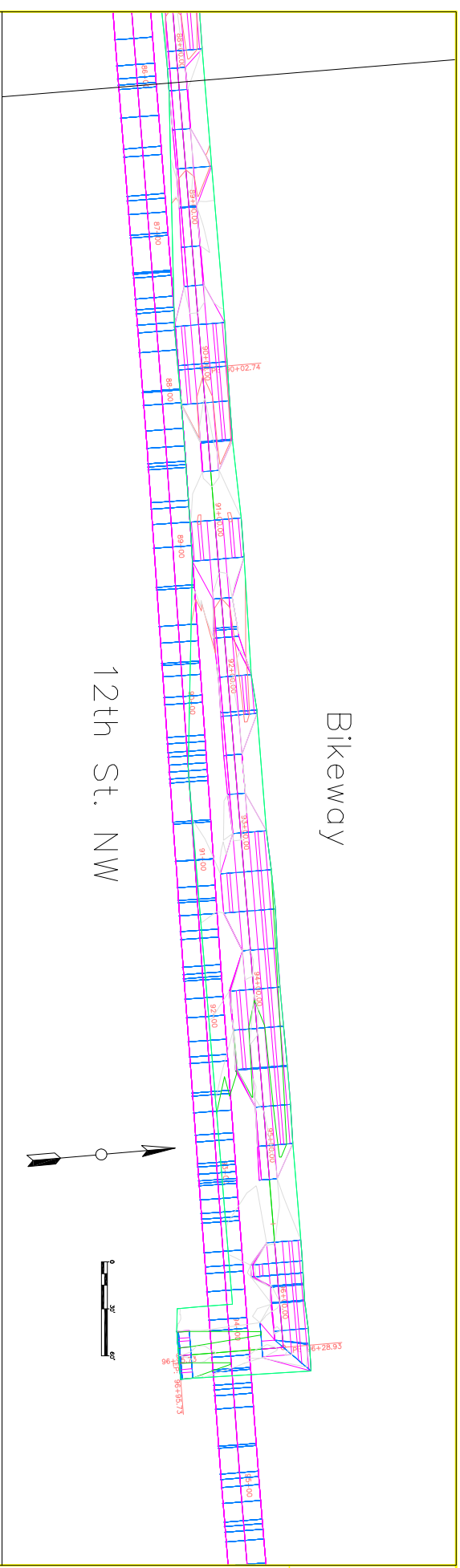

Section 1 PROFILE

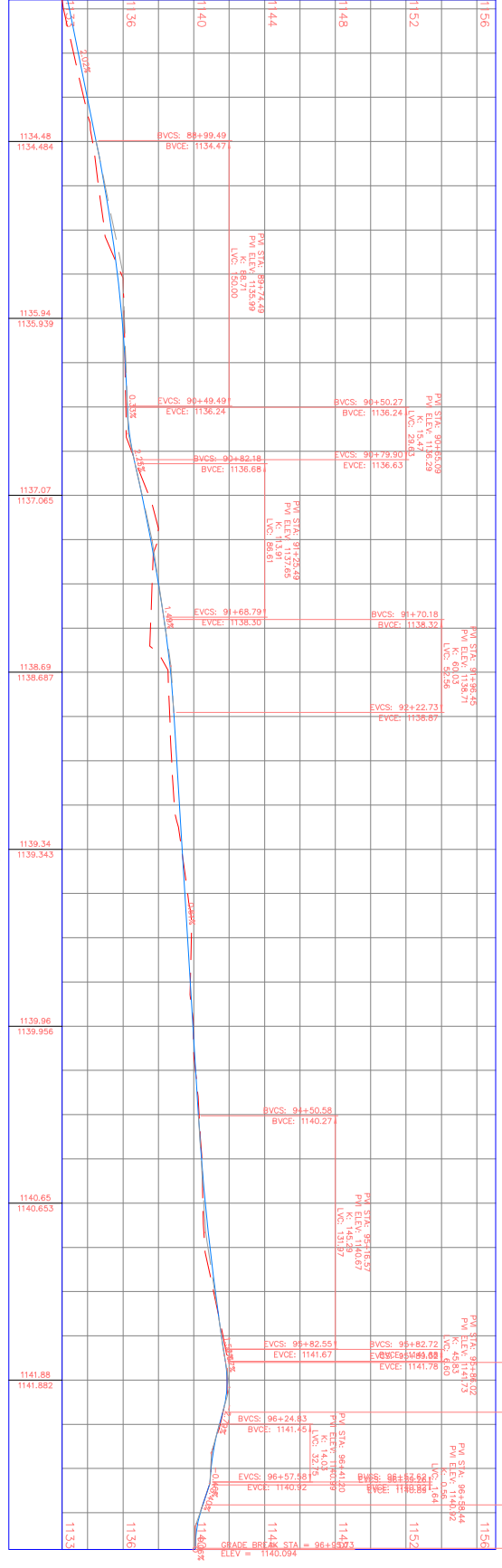

PROJECT:	RFD-5
DATE :	4/25/17
DRAWN BY:	ATRK
REVISION:	

THE UNIVERSITY OF IOWA
CIVIL AND ENVIRONMENTAL ENGINEERING
 4105 SEAMANS CENTER FOR THE
 ENGINEERING ARTS AND SCIENCES
 103 S. CAPITOL ST
 IOWA CITY, IOWA 52242
 PHONE: 319.335.5647
 FAX: 319.335.5660
 EMAIL: civil-hawks@uiowa.edu



EDUCATIONAL, NOT FOR CONSTRUCTION

BRIDGE AND BIKEWAY

N TAFT ST AND 12TH ST
 MASON CITY, IA 50402

SHEET NAME

SHEET NO.

S11

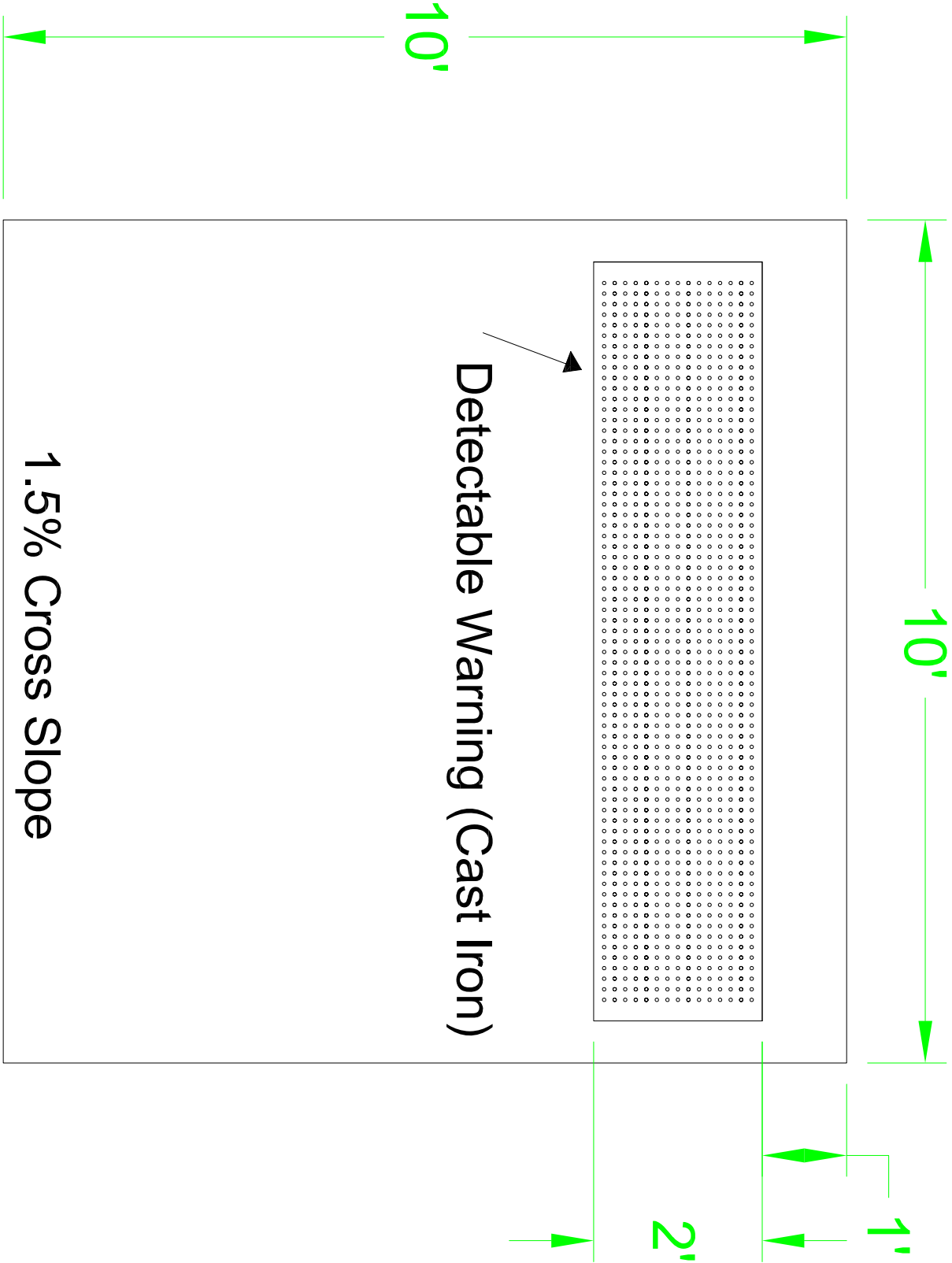

SHEET NO.
S12

SHEET NAME

BRIDGE AND BIKEWAY

N TAFT ST AND 12TH ST
MASON CITY, IA 50402

EDUCATIONAL - NOT
FOR CONSTRUCTION



**THE UNIVERSITY OF IOWA
CIVIL AND ENVIRONMENTAL ENGINEERING**

4105 SEAMANS CENTER FOR THE
ENGINEERING ARTS AND SCIENCES
103 S CAPITOL ST
IOWA CITY, IOWA 52242
PHONE: 319.335.5647
FAX: 319.335.5660
EMAIL: civil-hawks@uiowa.edu

PROJECT: RFD-5
DATE : 4/25/17
DRAWN BY: ATRK

REVISION:

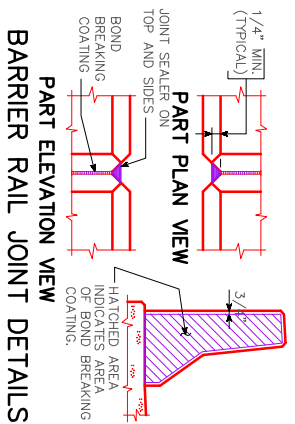
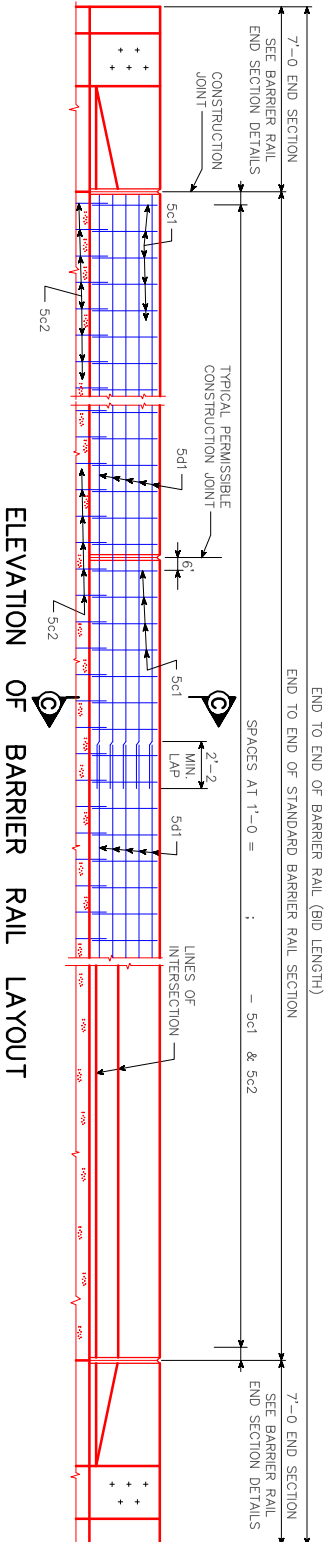

EPOXY REINF. STEEL—TWO BARRIER RAILS

SECTION	BAR	LOCATION	SHAPE	NO.	LENGTH	WEIGHT
STANDARD SECTION	5c1	VERTICAL	U	5	5'-11"	
	5c2	VERTICAL	U	1	6'-0"	
	5d1	LONGITUDINAL	—			
TOTAL (LBS)						

NOTE: REINFORCING STEEL QUANTITIES ARE INCLUDED ON THE SUMMARY QUANTITIES SHEET.

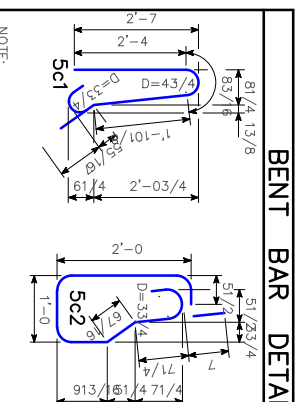

CONCRETE PLACEMENT SUMMARY

SECTION	TOTAL	
STANDARD SECTION	0.1052 CU.YD. PER FT.	
CONCRETE BARRIER RAIL QUANTITIES		
ITEM	UNIT	QUANTITY
CONCRETE BARRIER RAILING	L.F.	
TOTAL (CU. YD.)		

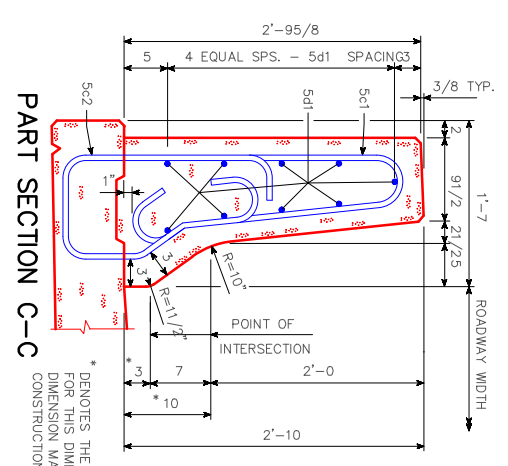

DESIGN FOR 0° SKEW
75'-0" x 40'-0"
 SINGLE SPAN BRIDGE
HYBRID COMPOSITE BEAM BRIDGE
BARRIER RAIL DETAILS
 STATION 28+42.18 = CENTERLINE 12TH ST. BRIDGE
CERRO GORDO COUNTY
 MAY 2017
 CITY OF MASON CITY
 DESIGN SHEET NO. _____ OF _____ FILE NO. _____ DESIGN NO. _____

BARRIER RAIL NOTES:

MINIMUM CLEAR DISTANCE FROM FACE OF CONCRETE TO NEAR REINFORCING BAR IS TO BE 2" UNLESS OTHERWISE NOTED OR SHOWN.
 THE PERMISSIBLE CONSTRUCTION JOINTS ARE TO BE PLACED BETWEEN VERTICAL BARS AT A MINIMUM SPACING OF 20 FEET. CONSTRUCTION JOINT CONTACT SURFACES ARE TO BE COATED WITH AN APPROVED BOND BREAKER. COST OF THE JOINT SEALER AND BOND BREAKER SHALL BE CONSIDERED INCIDENTAL TO OTHER CONSTRUCTION.
 ALL BARRIER RAIL REINFORCING STEEL IS TO BE EPOXY COATED.
 THE CONCRETE BARRIER RAIL IS TO BE BID ON A LINEAL FOOT BASIS. THE NUMBER OF LINEAL FEET OF BARRIER RAIL INSTALLED WILL BE PAID FOR AT THE CONTRACT PRICE PER LINEAL FOOT BASED ON PLAN QUANTITIES. PRICE BID FOR CONCRETE BARRIER RAILING SHALL BE FULL COMPENSATION FOR FURNISHING ALL MATERIAL, EXCLUDING REINFORCING STEEL, AND ALL OF THE EQUIPMENT AND LABOR REQUIRED TO ERECT THE RAIL IN ACCORDANCE WITH THESE PLANS AND CURRENT SPECIFICATIONS. IF CONDUIT IS REQUIRED INCLUDING LABOR AND ANY ADDITIONAL WORK TO DO THE INSTALLATION IS CONSIDERED INCIDENTAL TO THE COST OF THE RAILING.
 THE JOINT SEALER SHALL BE LIGHT GRAY NONSAG LATEX CAULKING SEALER MARKED FOR OUTDOOR USE. NO TESTING OR CERTIFICATION IS REQUIRED. TOP OF THE BARRIER RAIL IS TO BE PARALLEL TO THE THEORETICAL GRADE.
 CROSS SECTIONAL AREA OF THE STANDARD SECTION OF THE BARRIER RAIL = 284 SQUARE FEET.

BRIDGE AND BIKEWAY
12TH ST. OVER WILLOW CREEK
MASON CITY, IOWA

EDUCATIONAL, NON-PROFIT ORGANIZATION

THE UNIVERSITY OF IOWA
CIVIL AND ENVIRONMENTAL ENGINEERING

4105 SEAMANS CENTER FOR THE ENGINEERING ARTS AND SCIENCES
103 S CAPITOL ST
IOWA CITY, IOWA 52242
PHONE: 319.335.5647
FAX: 319.335.5660
EMAIL: civil-hawks@iowa.edu

PROJECT: 005
DATE: 5/1/2017
DRAWN BY: ZRG
REVISION:

SHEET NO.
S13

SHEET NAME

TRAFFIC CONTROL PLAN

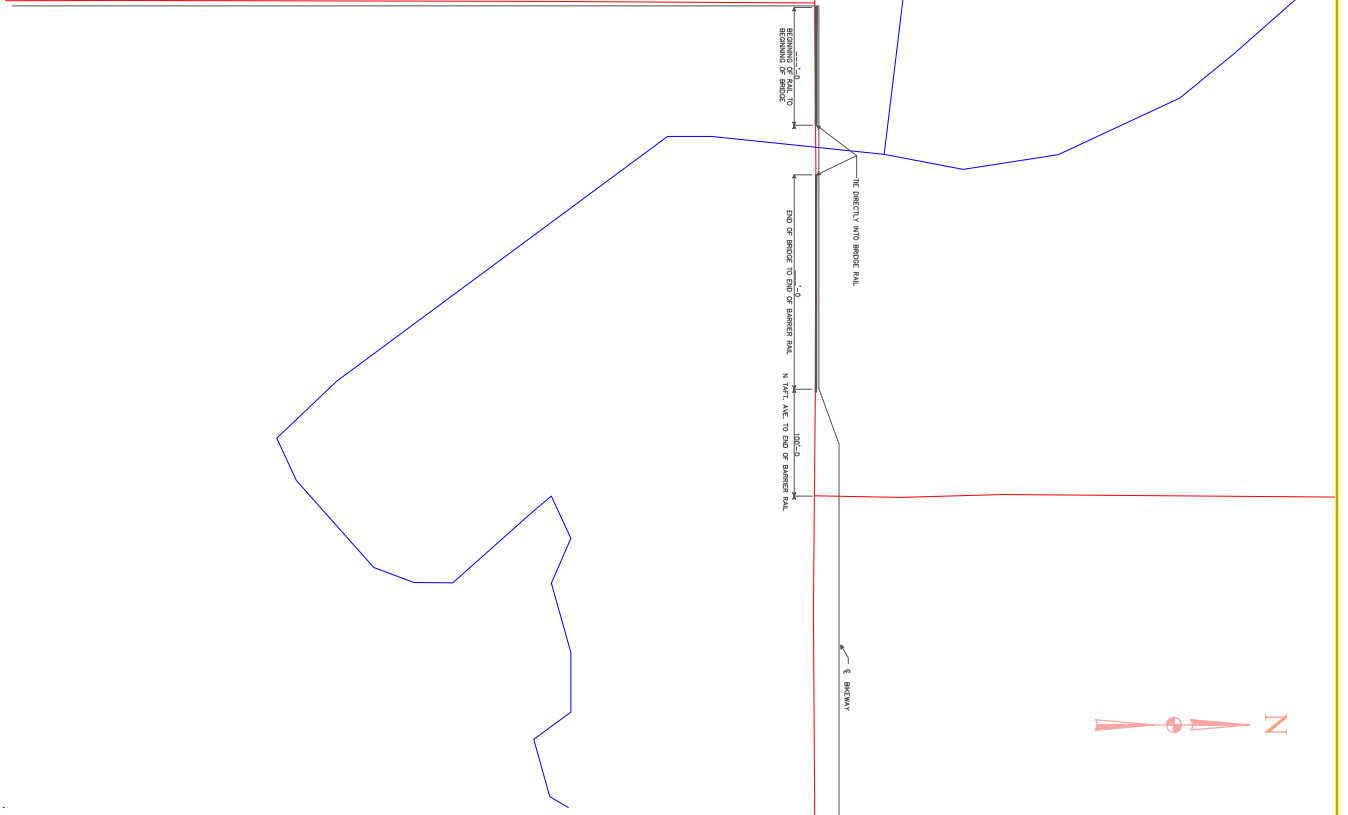

SIGNAGE DETAILS:

- ① LIGHTED ROAD CLOSED SIGN AND ROAD CLOSURE BARRIERS
- ② ROAD CLOSED AHEAD SIGN
- ③ 12TH ST. DETOUR
- ④ 12TH ST. DETOUR-TURN LEFT
- ⑤ 12TH ST. DETOUR-TURN RIGHT
- ⑥ END DETOUR

TRAFFIC NOTES:

ALL SIGNAGE IS TO BE PLACED AT LEAST 24 HOURS BEFORE CLOSURE OF THE BRIDGE AND IS TO REMAIN FOR THE DURATION OF THE PROJECT. SIGNS SHALL BE PROVIDED BY THE CONTRACTOR AND MUST BE PLACED IN ACCORDANCE WITH IOWA DOT TRAFFIC REQUIREMENTS.

DESIGN FOR 0° SKEW
75'-0" x 40'-0"
 BRIDGE AND BIKEWAY
 SINGLE SPAN BRIDGE
BARRIER RAIL PLACEMENT DETAILS
 STATION 28+42.18 = CENTERLINE 12TH ST. BRIDGE
CERRO GORDO COUNTY
 MAY 2017
 CITY OF MASON CITY
 DESIGN SHEET NO. _____ OF _____ FILE NO. _____ DESIGN NO. _____

<p>BRIDGE AND BIKEWAY</p> <p>12TH ST. OVER WILLOW CREEK MASON CITY, IOWA</p>	 <p>THE UNIVERSITY OF IOWA CIVIL AND ENVIRONMENTAL ENGINEERING</p> <p>4105 SEAMANS CENTER FOR THE ENGINEERING ARTS AND SCIENCES 103 S CAPITOL ST IOWA CITY, IOWA 52242 PHONE: 319.335.5642 FAX: 319.335.5660 EMAIL: civil-hawks@uiowa.edu</p>	<p>PROJECT: 005</p> <p>DATE : 5/1/2017</p> <p>DRAWN BY: ZRG</p> <p>REVISION:</p>	<p>EDUCATIONAL, NOT FOR CONSTRUCTION</p>	<p>SHEET NO.</p> <p>S14</p>
---	--	--	--	------------------------------------

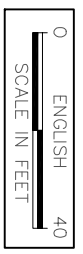
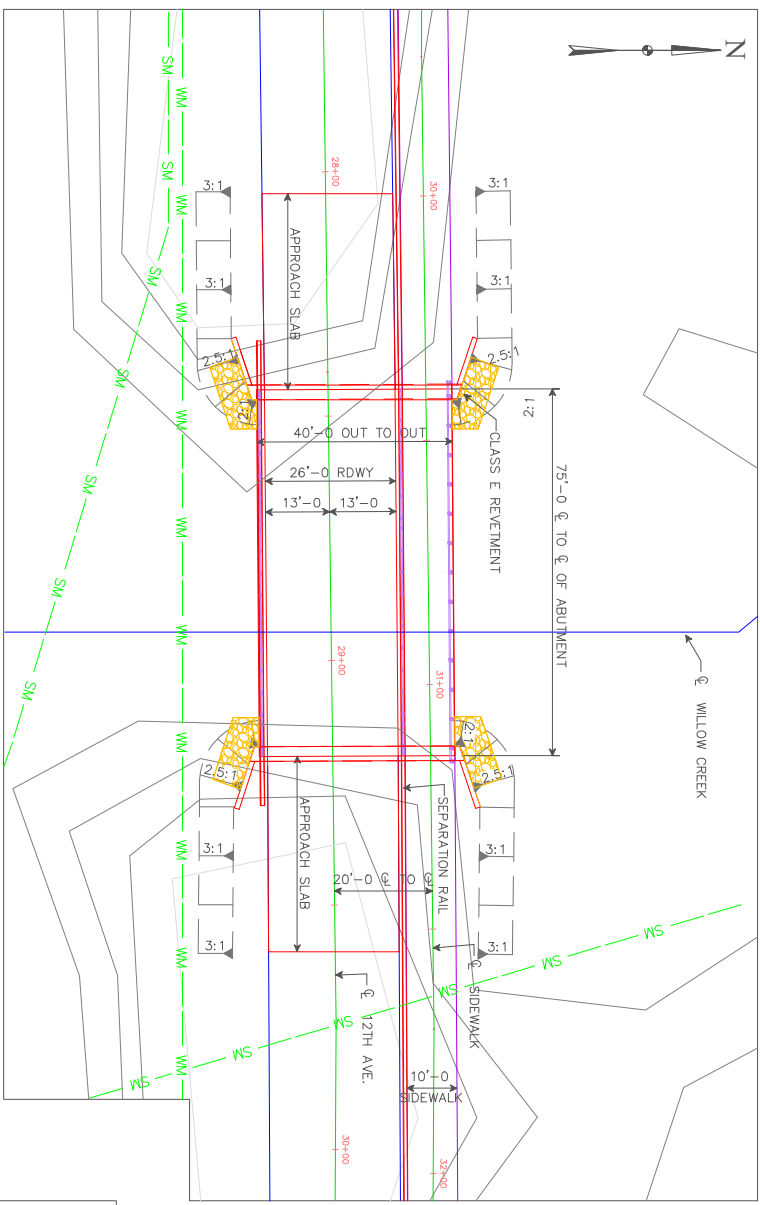
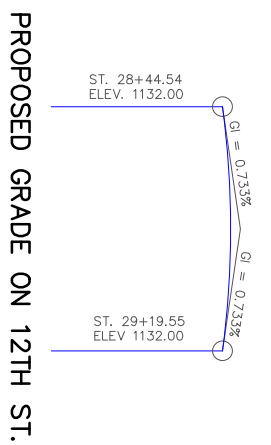
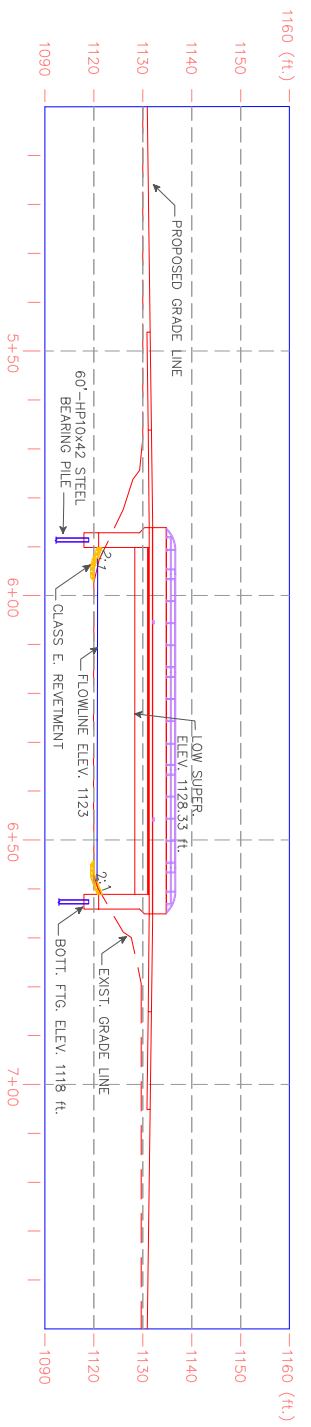

LONGITUDINAL SECTION ALONG Q OF ROADWAY - 12TH ST.

SITUATION PLAN

LOCATION
 12TH ST. OVER WILLOW CREEK
 T-N R-W
 SECTION 7
 CITY OF MASON CITY
 CERRO GORDO COUNTY
 F.H.W.A.
 LAT./LONG. -----

HYDRAULIC DATA
 DRAINAGE AREA = 3.70 SQ. MI.
 Q30 = 7390 CFS
 NATURAL STAGE = 1124 FT
 BACKWATER = 200 FT
 DRAINAGE AREA = 3.70 SQ. MI.
 Q100 = 8860 CFS
 NATURAL STAGE = 1126FT
 BACKWATER = 200 FT
 DRAINAGE AREA = 3.70 SQ. MI.
 Q200 = 11300 CFS
 NATURAL STAGE = 1127 FT
 BACKWATER = 200 FT

TRAFFIC DATA
 A.D.T.=6750 (2015)
 A.D.T.=8500 (2025)
 15% TRUCK TRAFFIC

UTILITIES LEGEND
 CITY WATER MAIN ——— WM ———
 CITY SEWER MAIN ——— SM ———

DESIGN FOR 0° SKEW
75'-0 x 40'-0
 SINGLE SPAN BRIDGE
HYBRID COMPOSITE BEAM BRIDGE

ABUTMENT DETAILS
 STATION 28+42.18 = CENTERLINE 12TH ST. BRIDGE
CERRO GORDO COUNTY
 MAY 2017
 CITY OF MASON CITY

DESIGN SHEET NO. _____ OF _____ FILE NO. _____ DESIGN NO. _____

SHEET NO.
V1

SHEET NAME

BRIDGE AND BIKEWAY

12TH STREET OVER WILLOW CREEK
 MASON CITY, IA 50402



THE UNIVERSITY OF IOWA
CIVIL AND ENVIRONMENTAL ENGINEERING
 4105 SEAMANS CENTER FOR THE
 ENGINEERING ARTS AND SCIENCES
 103 S CAPITOL ST
 IOWA CITY, IOWA 52242
 PHONE: 319.335.5642
 FAX: 319.335.5660
 EMAIL: civil-hawks@iowa.edu

PROJECT:	CEE: 3084: 0001
DATE :	5/5/17
DRAWN BY:	ZRG
REVISION:	

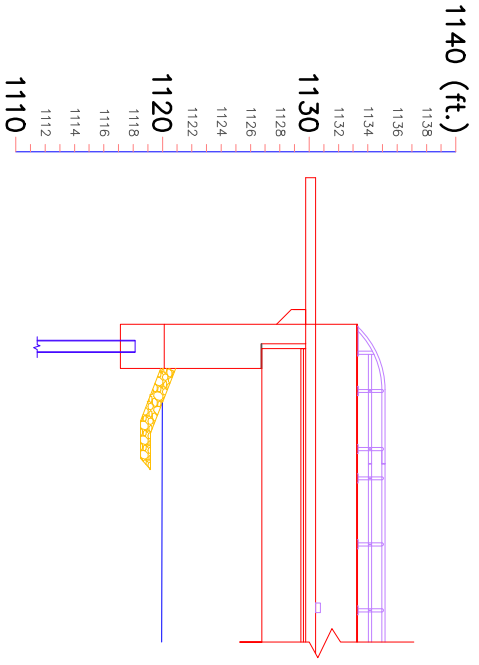

BRIDGE ELEVATION—SECTION AT ABUTMENT

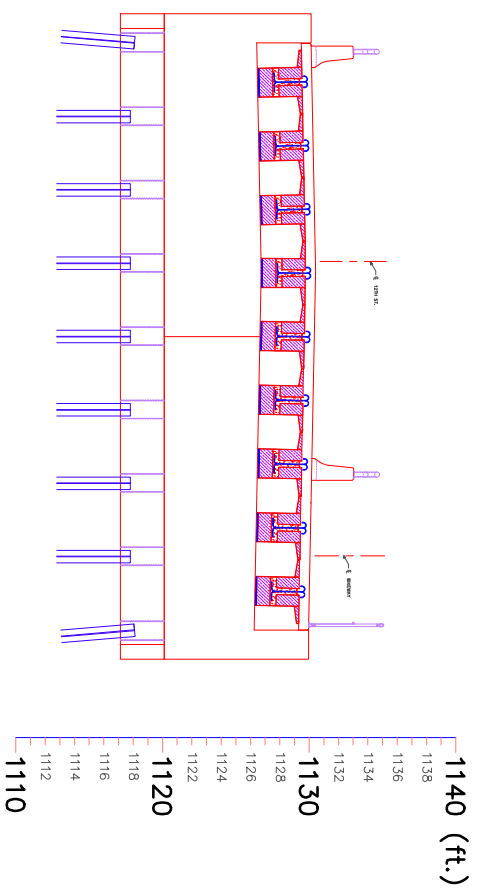

BRIDGE CROSS—SECTION AT ABUTMENT

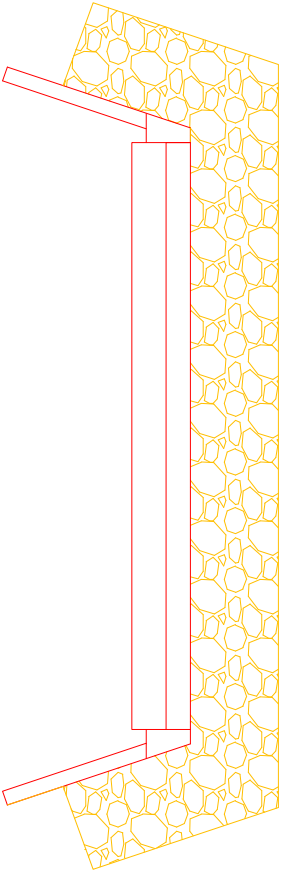

PLAN VIEW—SECTION AT ABUTMENT

DESIGN FOR 0° SKEW
75'-0 x 40'-0
 SINGLE SPAN BRIDGE
HYBRID COMPOSITE BEAM BRIDGE
ABUTMENT DETAILS
 STATION 28+42.18 = CENTERLINE 12TH ST. BRIDGE
CERRO GORDO COUNTY
 MAY 2017
 CITY OF MASON CITY
 DESIGN SHEET NO. ____ OF ____ FILE NO. ____ DESIGN NO. ____

SHEET NO. **V2**
 SHEET NAME

BRIDGE AND BIKEWAY

12TH STREET OVER WILLOW CREEK
 MASON CITY, IA 50402

EDUCATIONAL, NOT FOR CONSTRUCTION



THE UNIVERSITY OF IOWA
CIVIL AND ENVIRONMENTAL ENGINEERING
 4105 SEAMANS CENTER FOR THE
 ENGINEERING ARTS AND SCIENCES
 103 S CAPITOL ST
 IOWA CITY, IOWA 52242
 PHONE: 319.335.5647
 FAX: 319.335.5660
 EMAIL: civil-hawks@uiowa.edu

PROJECT:	CEE: 3084: 0001
DATE :	5/5/17
DRAWN BY:	ZRG
REVISION:	

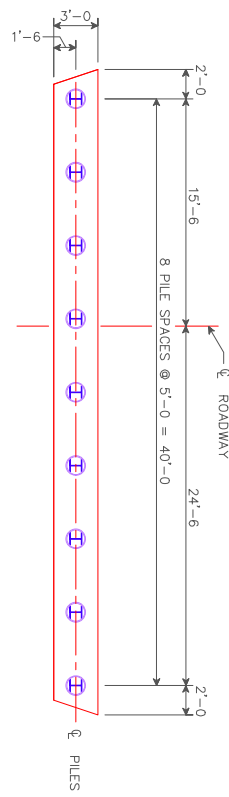

STEEL PILING LAYOUT

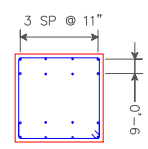
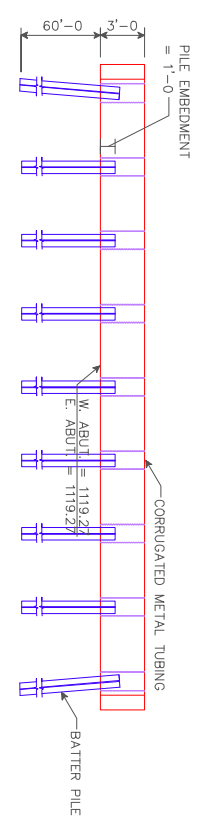

SECTION A-A

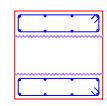

SECTION B-B

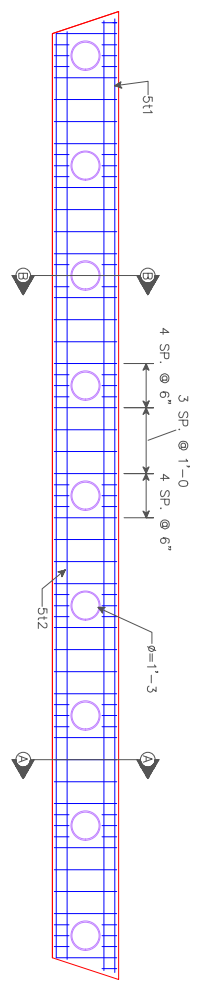

PLAN VIEW

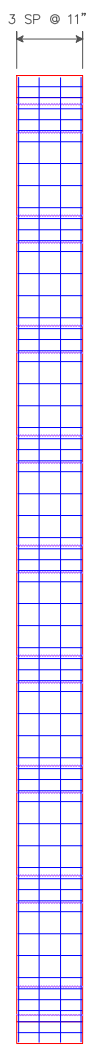

ELEVATION VIEW

BENT BAR DETAILS

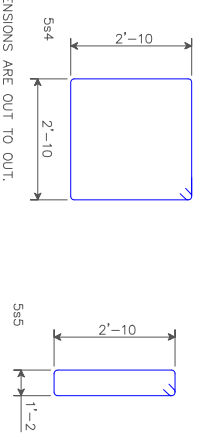

NOTE:
ALL DIMENSIONS ARE OUT TO OUT.
D = PIN DIAMETER.

PILE LENGTHS

LOCATION	SHAPE	NO.	LENGTH
EXTERIOR BATTER PILES	10x42	4	61'-0"
INTERIOR BEARING PILES	10x42	28	60'-0"
			TOTAL 1924'-0"

EPOXY REINF. STEEL

BAR	LOCATION	SHAPE	NO.	LENGTH	WEIGHT
5s4	VERTICAL	□	68	12'-4"	872
5s5	VERTICAL	□	112	8'-0"	968
513	HORIZONTAL	—	32	23'-0"	765
514	HORIZONTAL	—	32	25'-0"	832
					TOTAL (LBS) 3,437

CONCRETE PLACEMENT SUMMARY

SECTION	TOTAL
EAST ABUTMENT	14.3
WEST ABUTMENT	14.3
TOTAL (CU. YD.) 18.6	

FOUNDATION NOTES:

ALL MATERIAL AND DIMENSIONS ARE ESTIMATES FOR PRELIMINARY DESIGN AND SHOULD NOT BE USED WITHOUT REVISION. FINAL DESIGN OF THIS PROJECT. ALL DESIGNS ARE CONSIDERED PRELIMINARY AND FOR EDUCATIONAL PURPOSES ONLY.
ALL PILING ARE HP 10 X 42 PILES WITH EMBEDMENT OF 60'-0" UNLESS BEARING REQUIREMENT MET DURING DRIVING.
MINIMUM CLEAR DISTANCE OF CONCRETE TO NEAR REINFORCING BAR IS TO BE 2 INCHES UNLESS OTHERWISE NOTED.
ALL STEEL REINFORCING IS TO BE GRADE 60 STEEL.
ABUTMENT PILING WAS DESIGNED FOR HL-93 LOADING WITH AN ALLOWANCE FOR 20 LBS. PER SQ.FT. FUTURE WEARING SURFACE.

DESIGN FOR 0° SKEW
75'-0" x 40'-0"
HYBRID COMPOSITE BEAM BRIDGE
SINGLE SPAN BRIDGE
ABUTMENT DETAILS
STATION 28+42.18 = CENTERLINE 12TH ST. BRIDGE
CERRO GORDO COUNTY
MAY 2017
CITY OF MASON CITY
DESIGN SHEET NO. ___ OF ___ FILE NO. ___ DESIGN NO. ___

DESIGN SHEET NO. ___ OF ___ FILE NO. ___ DESIGN NO. ___

THE UNIVERSITY OF IOWA
CIVIL AND ENVIRONMENTAL ENGINEERING
4105 SEAMANS CENTER FOR THE ENGINEERING ARTS AND SCIENCES
103 S CAPITOL ST
IOWA CITY, IOWA 52242
PHONE: 319.335.5647
FAX: 319.335.5660
EMAIL: civil-hawks@uiowa.edu

PROJECT: CEE: 3084-0001
DATE: 5/5/17
DRAWN BY: ZRG
REVISION:



EDUCATIONAL, NOT FOR CONSTRUCTION

BRIDGE AND BIKEWAY

12TH STREET OVER WILLOW CREEK
MASON CITY, IA 50402

SHEET NO. **V4**
SHEET NAME

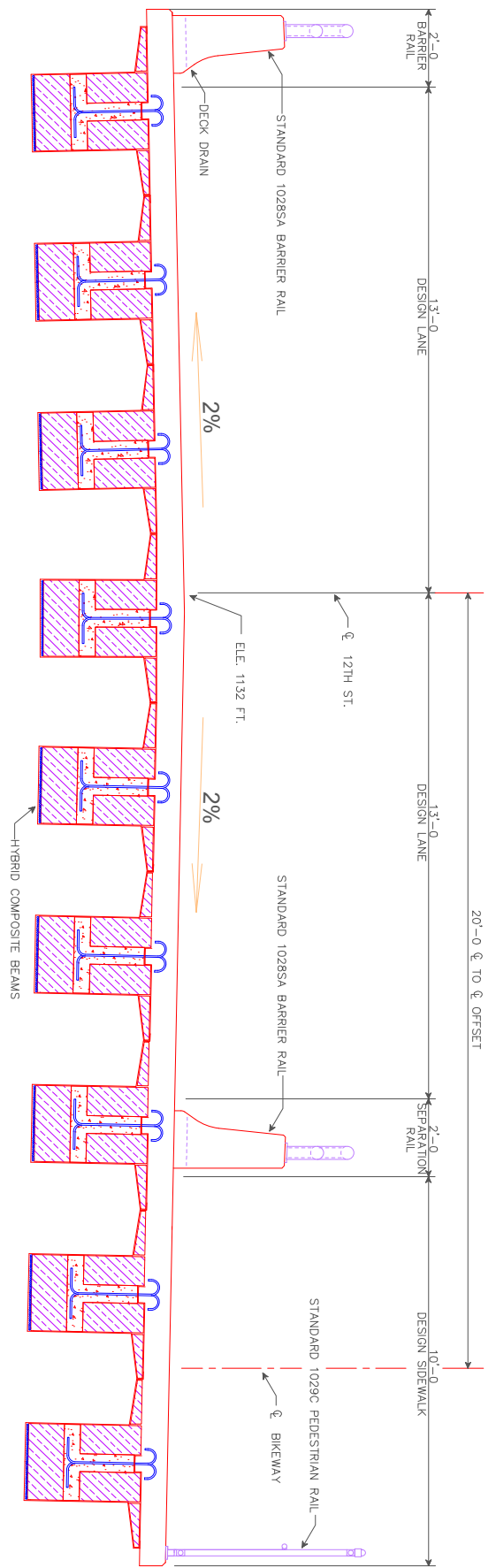

SUPERSTRUCTURE NOTES:

ALL MATERIAL AND DIMENSIONS ARE ESTIMATES FOR PRELIMINARY DESIGN AND SHOULD NOT BE USED WITHOUT VERIFICATION IN FINAL DESIGN OF THIS PROJECT. ALL DESIGNS ARE CONSIDERED PRELIMINARY AND FOR EDUCATIONAL PURPOSES ONLY.

CENTERLINE OF BRIDGE DECK ALIGNS WITH EXISTING CENTERLINE OF 12TH STREET. BRIDGE DECK SLOPES AWAY FROM THE CENTERLINE.

BRIDGE DECK IS TO BE PLACED AS A SINGLE UNIT. DEPTH OF PAVEMENT ON BRIDGE IS 8" PER IOWA DOT STANDARDS. TYPICAL GRADING SLOPE OF 2% USED FOR DRAINAGE OF ROADWAY.

MINIMUM CLEAR DISTANCE OF CONCRETE TO NEAR REINFORCING BAR IS TO BE 3 INCHES UNLESS OTHERWISE NOTED. ALL STEEL REINFORCING IS TO BE GRADE 60 STEEL.

TYPICAL DESIGNS AND STANDARD SHEETS FOR BRIDGE COMPONENTS ON FOLLOWING SHEETS.

LONG. REBAR DETAIL

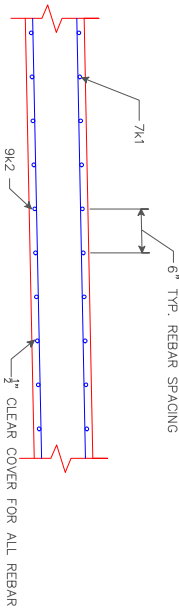

TRANS. REBAR DETAIL

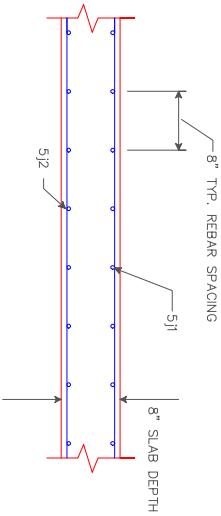

EPOXY REINF. STEEL

BAR	LOCATION	SHAPE	NO.	LENGTH	WEIGHT
5/1	TRANSVERSE REINF. TOP	—	238	23'-0"	5,693
5/2	TRANSVERSE REINF. BOTTOM	—	238	23'-0"	5,693
7/4	LONGITUDINAL REINF. TOP	—	240	28'-0"	13,209
9/4	LONGITUDINAL REINF. BOTTOM	—	240	28'-0"	22,042
TOTAL (LBS)					47,936

CONCRETE PLACEMENT SUMMARY

SECTION	TOTAL
BRIDGE DECK	74.1
TOTAL (CU. YD.)	74.1

DESIGN FOR 0° SKEW
75'-0" x 40'-0"
 SINGLE SPAN BRIDGE
HYBRID COMPOSITE BEAM BRIDGE

SUPERSTRUCTURE DETAILS
 STATION 28+42.18 = CENTERLINE 12TH ST. BRIDGE
CERRO GORDO COUNTY
 MAY 2017

CITY OF MASON CITY
 DESIGN SHEET NO. ___ OF ___ FILE NO. ___ DESIGN NO. ___

THE UNIVERSITY OF IOWA
CIVIL AND ENVIRONMENTAL ENGINEERING
 4105 SEAMANS CENTER FOR THE
 ENGINEERING ARTS AND SCIENCES
 103 S CAPITOL ST
 IOWA CITY, IOWA 52242
 PHONE: 319.335.5642
 FAX: 319.335.5660
 EMAIL: civil-hawks@iowa.edu

PROJECT:	CEE: 3084: 0001
DATE :	5/5/17
DRAWN BY:	ZRG
REVISION:	



EDUCATIONAL, NOT
 PROFESSIONAL

BRIDGE AND BIKEWAY

12TH STREET OVER WILLOW CREEK
 MASON CITY, IA 50402

SHEET NAME

SHEET NO.

V5

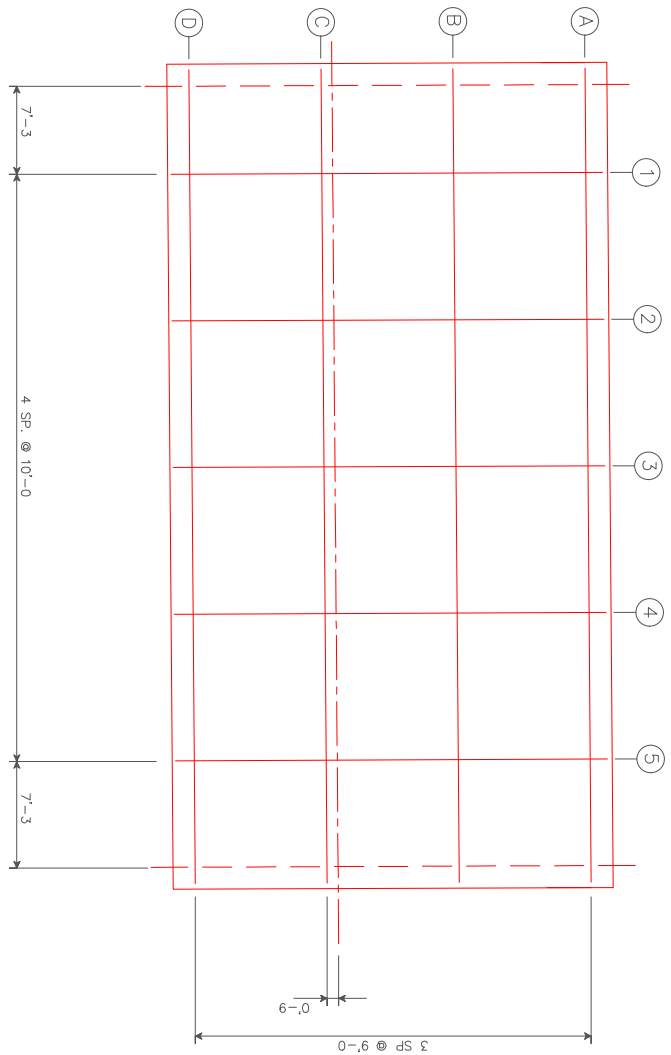

TOP OF SLAB ELEVATIONS							
LOCATION	℄ W. ABUT. BRG.	1	2	3	4	5	℄ E. ABUT. BRG.
NORTH EDGE OF BRIDGE	1131.50			1132.05			1131.50
LINE A	1131.65			1132.20			1131.65
℄ PEDESTRIAN WALKWAY	1131.60			1132.15			1131.60
LINE B	1131.84			1132.39			1131.84
℄ APPROACH ROADWAY	1132.00			1132.55			1132.00
LINE C	1131.99			1131.54			1131.99
LINE D	1131.81			1131.36			1131.81
SOUTH EDGE OF BRIDGE	1131.70			1132.25			1131.70

DESIGN FOR 0' SK&PW
75'-0" x 40'-0"
 SINGLE SPAN BRIDGE
HYBRID COMPOSITE BEAM BRIDGE
TOP OF SLAB ELEVATIONS
 STATION 28+42.18 = CENTERLINE 12TH ST. BRIDGE
CERRO GORDO COUNTY
 MAY 2017
 CITY OF MASON CITY
 DESIGN SHEET NO. _____ OF _____ FILE NO. _____ DESIGN NO. _____

PROJECT: CEE: 3084: 0001
 DATE: 5/5/17
 DRAWN BY: ZRG
 REVISION:

THE UNIVERSITY OF IOWA
CIVIL AND ENVIRONMENTAL ENGINEERING
 4105 SEAMANS CENTER FOR THE
 ENGINEERING ARTS AND SCIENCES
 103 S. CAPITOL ST.
 IOWA CITY, IOWA 52242
 PHONE: 319.335.5647
 FAX: 319.335.5660
 EMAIL: civil-hawks@uiowa.edu



EDUCATIONAL NOT
 FOR CONSTRUCTION

BRIDGE AND BIKEWAY
 12TH STREET OVER WILLOW CREEK
 MASON CITY, IA 50402

SHEET NAME

SHEET NO.

V6

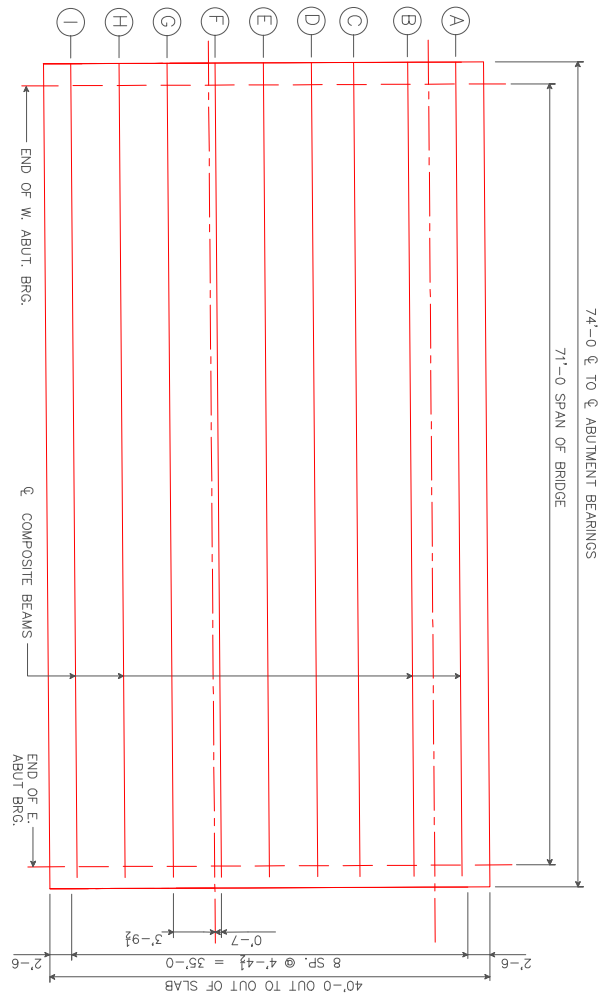

BEAM LAYOUT

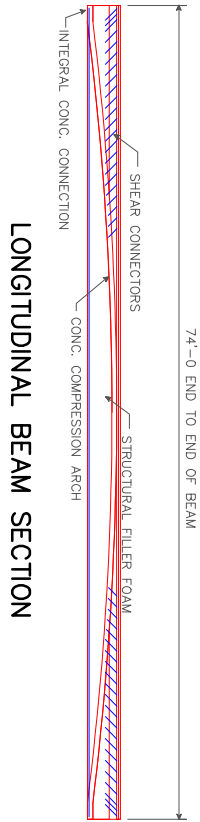

LONGITUDINAL BEAM SECTION

BRIDGE-BEAM CROSS SECTION

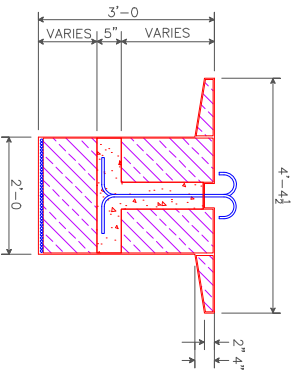

HCB TYPICAL SECTION

BEAM PLACEMENT DETAILS

BEAM NO.	LENGTH	WEST ELE.	EAST ELE.	NOTES
A	74'-0			
B	74'-0			
C	74'-0			
D	74'-0			
E	74'-0			
F	74'-0			
G	74'-0			
H	74'-0			
I	74'-0			
J	74'-0			

COMPOSITE BEAM NOTES:

ALL MATERIAL AND DIMENSIONS ARE ESTIMATES FOR PRELIMINARY DESIGN AND SHOULD NOT BE USED WITHOUT VERIFICATION IN FINAL DESIGN OF THIS PROJECT. ALL DESIGNS ARE CONSIDERED PRELIMINARY AND FOR EDUCATIONAL PURPOSES ONLY.

HYBRID COMPOSITE BEAMS SELECTED FROM HILLMAN HYBRID COMPOSITE BEAM COMPANY; DESIGN DEPTH OF BEAM IS 36" WITH INTEGRAL DECK FORM.

BEAMS ARE TO BE TRANSPORTED TO SITE EMPTY. ONCE BEAMS ARE ALIGNED ON ABUTMENTS, QUICK HIGH STRENGTH CONCRETE IS TO BE POURED IN MOLD SLOTS UNTIL FILLED. CONCRETE MUST BE GIVEN 24 HOURS TO DRY BEFORE WORK ON THE CONCRETE DECK MAY BEGIN.

BEAMS BEARING CONNECTION IS A 8"x22"x 1/2" NEOPRENE BEARING PAD WITH ADDITIONAL RUBBER PAD ON ALL OTHER BEARING SURFACES. ENDS OF BEAMS ENCASED IN CONCRETE TO CREATE AN INTEGRAL ABUTMENT CONNECTION.

DESIGN FOR 0° SKEW
75'-0 x 40'-0
 SINGLE SPAN BRIDGE
HYBRID COMPOSITE BEAM BRIDGE
BEAM LAYOUT DETAIL
 STATION 28+42.18 = CENTERLINE 12TH ST. BRIDGE
CERRO GORDO COUNTY
 MAY 2017
 CITY OF MASON CITY
 DESIGN SHEET NO. _____ OF _____ FILE NO. _____ DESIGN NO. _____

BRIDGE AND BIKEWAY

12TH STREET OVER WILLOW CREEK
 MASON CITY, IA 50402



THE UNIVERSITY OF IOWA
CIVIL AND ENVIRONMENTAL ENGINEERING
 4105 SEAMANS CENTER FOR THE
 ENGINEERING ARTS AND SCIENCES
 103 S CAPITOL ST
 IOWA CITY, IOWA 52242
 PHONE: 319.335.5642
 FAX: 319.335.5660
 EMAIL: civil-hawks@uiowa.edu

PROJECT:	CEE: 3084: 0001
DATE :	5/5/17
DRAWN BY:	ZRG
REVISION:	

SHEET NO.
V7

SHEET NAME

BENT BAR DETAILS

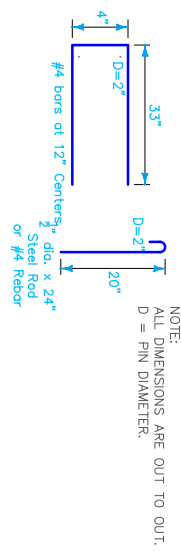

EPOXY REINF. STEEL-TWO BARRIER RAILS

BAR	LOCATION	SHAPE	NO.	LENGTH	WEIGHT
611	LONGITUDINAL REBAR TOP	---	58	20'-0"	1,740
612	LONGITUDINAL REBAR BOT.	---	116	20'-0"	4,018
513	LONGITUDINAL REBAR BOT.	---	58	20'-0"	5,194
414	END APPROACH REBAR	---	184	29'-0"	5,336
5m1	TRANSVERSE REBAR TOP	---	38	29'-0"	1,146
5m2	TRANSVERSE REBAR BOT.	---	76	29'-0"	2,292
				TOTAL (LBS)	10,054

CONCRETE PLACEMENT SUMMARY

SECTION	TOTAL
EAST APPROACH	37.0
WEST APPROACH	37.0
TOTAL (CU. YD.)	74.0

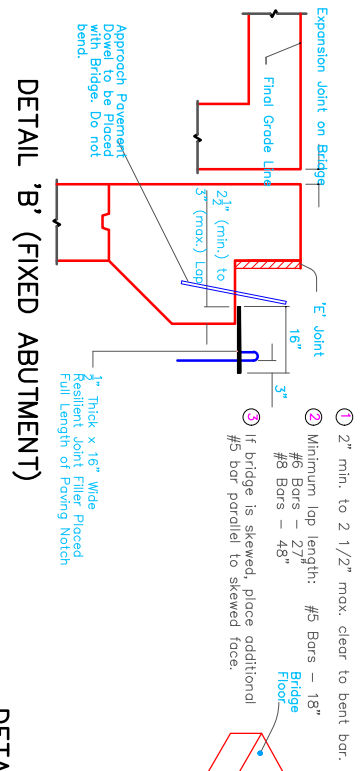

DETAIL 'D' (JOINT PLACEMENT)

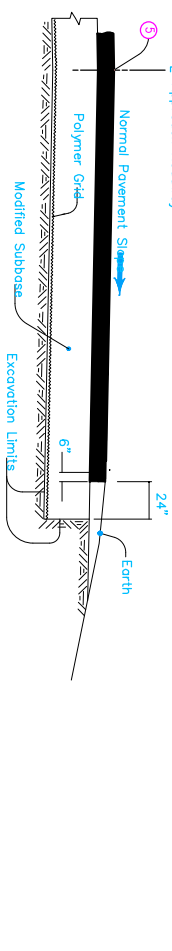

SECTION A-A

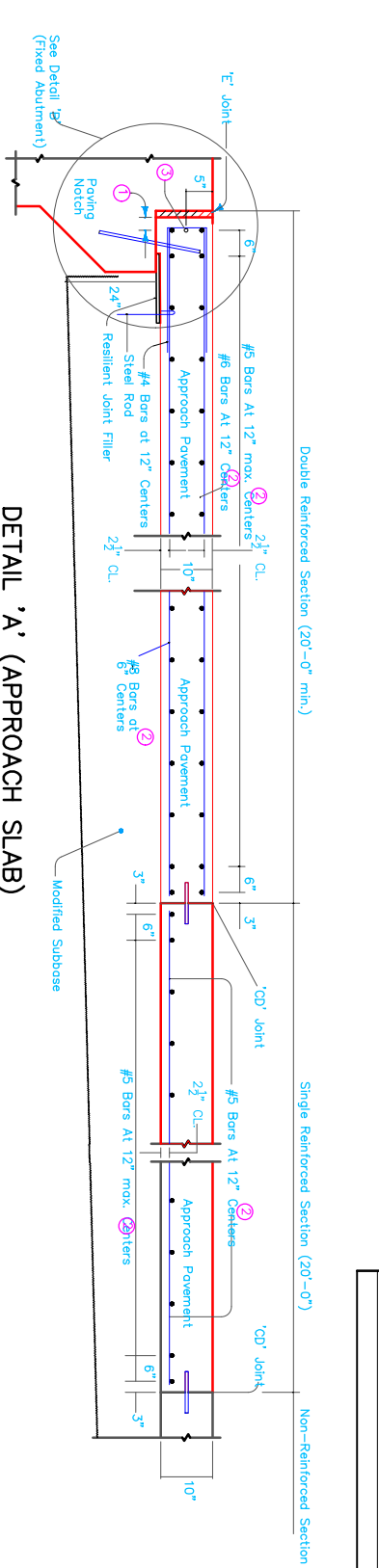

DETAIL 'A' (APPROACH SLAB)

- 1 Longitudinal Joint (PY-101): Single pour - Saw cut joint per Detail B. Two pours - Use 'KS-2' Joint.
- 2 Refer to BR-211, BR-212, or BR-231.
- 3 Design shoulder width.
- 4 Reinforced bridge approach section.
- 5 Expansion joint at end of Bridge Rail End Section: Place joint filler the full depth of the bridge approach pavement. In areas with curb, place full depth of pavement plus curb and shape material to fit the shape of the curb per Section B-B of PY-101. Seal joint per Detail F of PY-101.

APPROACH SLAB DETAILS

APPROACH SLAB DETAILS HERE

DESIGN FOR 0° SKEW
75'-0" x 40'-0"
 SINGLE SPAN BRIDGE
HYBRID COMPOSITE BEAM BRIDGE
APPROACH SLAB DETAILS
 STATION 28+42.18 = CENTERLINE 12TH ST. BRIDGE
CERRO GORDO COUNTY
 MAY 2017
 CITY OF MASON CITY

10" DOUBLE REINFORCED SECTION APPROACH SLAB | STANDARD SHEET BR-201

DESIGN SHEET NO. _____ OF _____ FILE NO. _____ DESIGN NO. _____

SHEET NO. **V8**

SHEET NAME

BRIDGE AND BIKEWAY

12TH STREET OVER WILLOW CREEK
 MASON CITY, IA 50402

EDUCATIONAL, NOT FOR CONSTRUCTION



THE UNIVERSITY OF IOWA CIVIL AND ENVIRONMENTAL ENGINEERING

4105 SEAMANS CENTER FOR THE ENGINEERING ARTS AND SCIENCES
 103 S CAPITOL ST
 IOWA CITY, IOWA 52242
 PHONE: 319.335.5642
 FAX: 319.335.5660
 EMAIL: civil-hawks@iowa.edu

PROJECT: CEE: 3084: 0001
 DATE: 5/5/17
 DRAWN BY: ZRG
 REVISION:

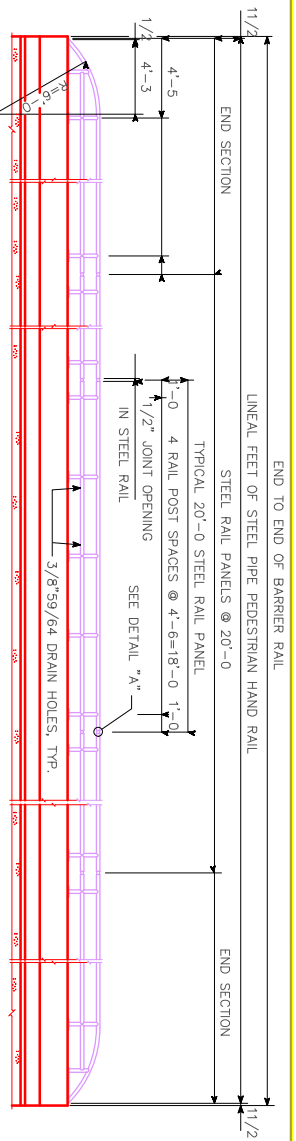

ELEVATION OF SIDEWALK BARRIER RAIL & STEEL PIPE PEDESTRIAN HAND RAIL

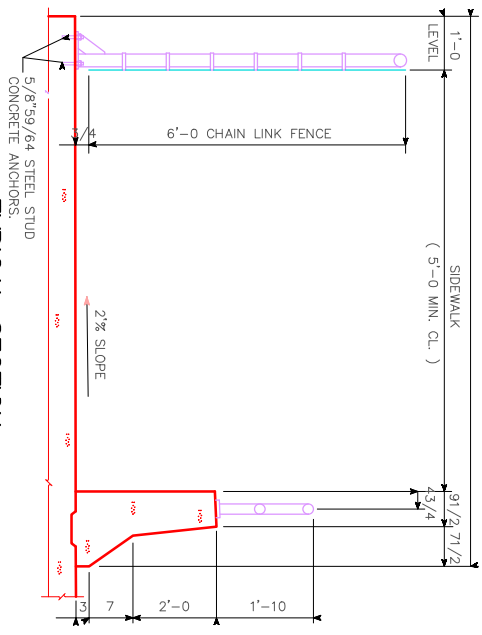

TYPICAL SECTION

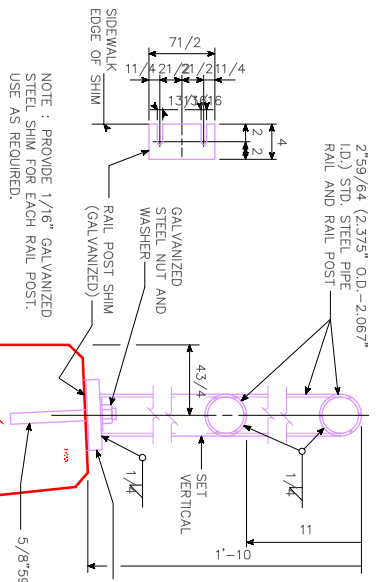

RAIL AND RAIL POST DETAILS

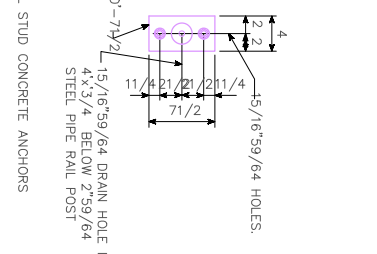

PART SECTION

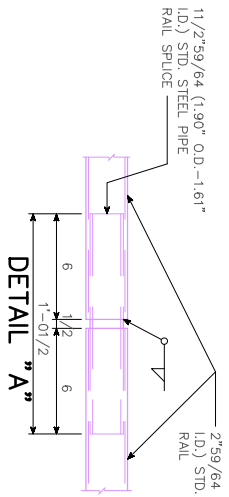

DETAIL "A"

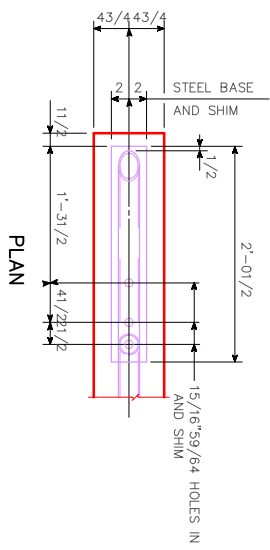

PLAN

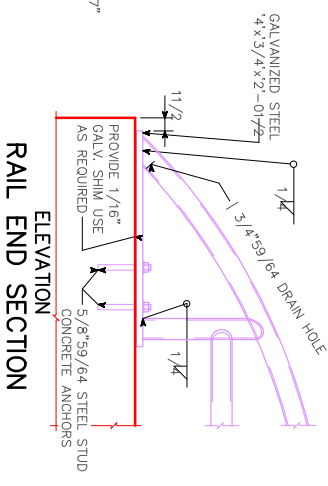

RAIL END SECTION

PEDESTRIAN HAND RAIL NOTES:
 THE STEEL PIPE PEDESTRIAN HAND RAIL IS TO BE BID ON A LINEAL FOOT BASIS MEASURED END TO END OF RAIL. THE PRICE BID FOR STEEL PIPE PEDESTRIAN HAND RAIL SHALL BE FULL COMPENSATION FOR FURNISHING ALL MATERIAL, INCLUDING ANCHOR BOLTS AND SHIMS, AND ALL OF THE EQUIPMENT AND LABOR REQUIRED TO ERECT THE RAIL IN ACCORDANCE WITH THESE PLANS AND SPECIFICATIONS. THE MATERIAL FOR TUBE RAILS, POSTS AND SPLICE TUBES SHALL BE STANDARD STEEL PIPE MEETING THE REQUIREMENTS OF ASTM A53, TYPE E OR S, GRADE B. BASE PLATES AND SHIMS SHALL MEET THE REQUIREMENTS OF ASTM A36. PANELS AND END SECTIONS SHALL BE GALVANIZED, AFTER FABRICATION, IN ACCORDANCE WITH THE REQUIREMENTS OF ASTM A123. ALL CUT ENDS ARE TO BE TRUE, SMOOTH, AND FREE OF BURS OR RAGGED EDGES. NO PAINTING WILL BE REQUIRED. THE STUD CONCRETE ANCHORS SHALL BE GALVANIZED AND HAVE A MINIMUM PULL OUT STRENGTH OF 8000 POUNDS BASED ON 4000 PSI CONCRETE. FOR DETAILS OF CONCRETE BARRIER RAIL SEE DESIGN SHEET _____ OF THESE PLANS.

F-SHAPE PEDESTRIAN RAIL-STEEL - INTEGRAL ABUTMENT STANDARD SHEET 1029C

DESIGN FOR 0° SKEW
75'-0" x 40'-0"
 SINGLE SPAN BRIDGE
PEDESTRIAN RAIL DETAILS
 STATION 28+42.18 = CENTERLINE 12TH ST. BRIDGE
CERRO GORDO COUNTY
 MAY 2017
 CITY OF MASON CITY
 DESIGN SHEET NO. _____ OF _____ FILE NO. _____ DESIGN NO. _____

SHEET NO.
V10

SHEET NAME

BRIDGE AND BIKEWAY

12TH STREET OVER WILLOW CREEK
 MASON CITY, IA 50402

EDUCATIONAL, NON-PROFIT ORGANIZATION



**THE UNIVERSITY OF IOWA
 CIVIL AND ENVIRONMENTAL ENGINEERING**

4105 SEAMANS CENTER FOR THE
 ENGINEERING ARTS AND SCIENCES
 103 S CAPITOL ST
 IOWA CITY, IOWA 52242
 PHONE: 319.335.5642
 FAX: 319.335.5660
 EMAIL: civil-hawks@iowa.edu

PROJECT: CEE: 3084-0001
 DATE: 5/5/17
 DRAWN BY: ZRG
 REVISION:

END POST, 2 1/2" x 59/64 (2.875" O.D. - 2.323" I.D.) EXTRA STRONG STEEL PIPE
 LINE POST, 2 1/2" x 59/64 (2.875" O.D. - 2.323" I.D.) EXTRA STRONG STEEL PIPE
 TOP RAIL, 1 1/4" x 59/64 (1.860" O.D. - 1.360" I.D.) STANDARD STEEL PIPE
 BRACE RAIL, 2" x 59/64 (2.375" O.D. - 2.067" I.D.) STANDARD STEEL PIPE
 BOTTOM RAIL, 2" x 59/64 (2.375" O.D. - 2.067" I.D.) STANDARD STEEL PIPE

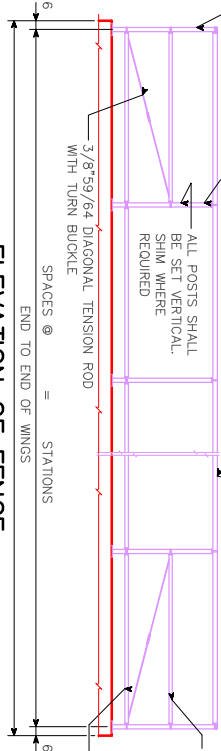

ELEVATION OF FENCE
 NOTE : MAXIMUM POST SPACING IS 10'-0".

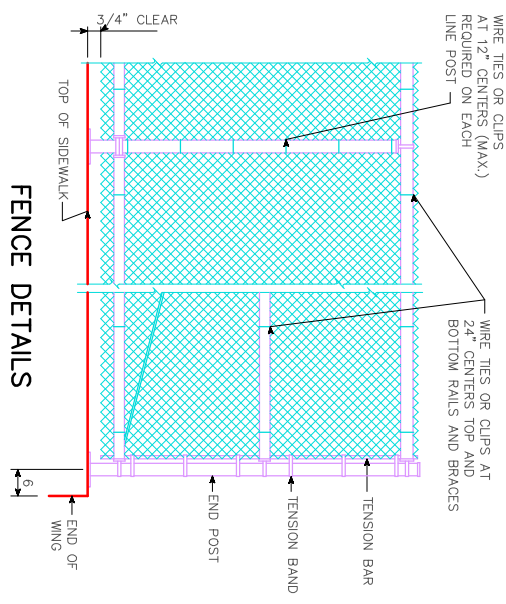

QUANTITIES

ITEM	UNITS	AMOUNT
STEEL PIPE PEDESTRIAN HAND RAIL	LN. FT.	150
CHAIN LINK FENCE, 72" HEIGHT	LN. FT.	95

STEEL CHAIN LINK FENCE NOTES:

THE CHAIN LINK FENCE IS TO BE BID ON A LINEAR FOOT BASIS MEASURED FROM 1 TO 1 OF END POSTS. THE PRICE BID FOR CHAIN LINK FENCE, 72" HEIGHT SHALL BE FULL COMPENSATION FOR FURNISHING ALL MATERIAL, INCLUDING CONCRETE ANCHORS AND SHIMS, AND ALL OF THE EQUIPMENT AND LABOR REQUIRED TO ERECT THE FENCE IN ACCORDANCE WITH THESE PLANS AND SPECIFICATIONS. THE CHAIN LINK FENCE SHALL BE EITHER ZINC OR ALUMINUM COATED FABRIC, Z. MESH 100, 9 WIRES, 72" HEIGHT WITH ROUNDED SELVAGES TOP AND BOTTOM. GALVANIZED AND THE STUD CONCRETE ANCHORS SHALL BE GALVANIZED AND HAVE A MIN PSI CONCRETE STRENGTH OF 8000 POUNDS BASED MATERIAL FOR POSTS. BRACES AND RAIL SHALL BE STEEL PIPE IN ACCORDANCE WITH ARTICLE 4154.10, PART OF THE STANDARD SPECIFICATIONS. BASE PLATES AND SHIMS SHALL MEET THE REQUIREMENTS OF ASTM A36. POSTS AND BASE PLATES SHALL BE GALVANIZED AFTER FABRICATION. IN ACCORDANCE WITH THE REQUIREMENTS OF ASTM A123. SPECIAL FITTINGS SHALL BE IN ACCORDANCE WITH ARTICLE 4154.11, OF THE STANDARD SPECIFICATIONS, UNLESS OTHERWISE NOTED. THE FENCE SHALL BE TRUE TO LINE, TAUT, AND COMPLY WITH THE BEST PRACTICE FOR FENCE CONSTRUCTION OF THIS TYPE. ALL ENDS OF WIRES SHALL BE TURNED SO THAT THEY EXTEND AWAY FROM THE SIDEWALK SIDE OF THE FENCE.

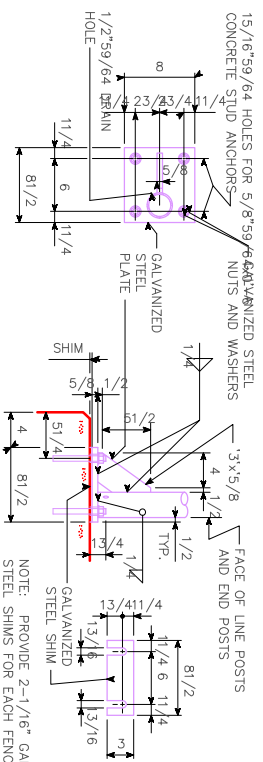

BASE PLATE DETAILS FOR END POST AND LINE POSTS
 NOTE : POSTS AND BASE PLATES SHALL BE GALVANIZED, AFTER FABRICATION, IN ACCORDANCE WITH THE REQUIREMENTS OF ASTM A123.

DESIGN FOR 0° SKEW
75'-0" x 40'-0"
 SINGLE SPAN BRIDGE
HYBRID COMPOSITE BEAM BRIDGE
PEDESTRIAN RAIL DETAILS
 STATION 28+42.18 = CENTERLINE 12TH ST. BRIDGE
CERRO GORDO COUNTY
 ILLINOIS
 CITY OF MASON CITY
 DESIGN SHEET NO. _____ OF _____ FILE NO. _____ DESIGN NO. _____

F-SHAPE PEDESTRIAN RAIL-STEEL - INTEGRAL ABUTMENT STANDARD SHEET 10299C



THE UNIVERSITY OF IOWA
CIVIL AND ENVIRONMENTAL ENGINEERING
 4105 SEAMANS CENTER FOR THE ENGINEERING ARTS AND SCIENCES
 103 S CAPITOL ST
 IOWA CITY, IOWA 52242
 PHONE: 319.335.5642
 FAX: 319.335.5660
 EMAIL: civil-hawks@iowa.edu

PROJECT: CEE: 3084: 0001
 DATE: 5/5/17
 DRAWN BY: ZRG
 REVISION:

BRIDGE AND BIKEWAY

12TH STREET OVER WILLOW CREEK
 MASON CITY, IA 50402

SHEET NO.
V11

SHEET NAME

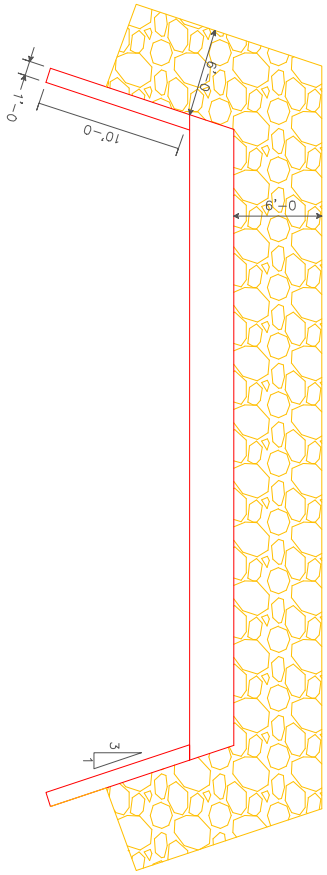

SCOUR PROTECTION DETAIL DETAIL

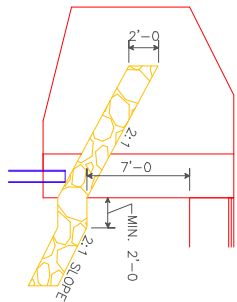

BENT BAR DETAILS

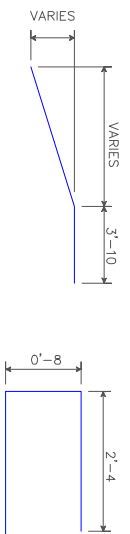

NOTE:
ALL DIMENSIONS ARE OUT TO OUT.
D = FIN DIAMETER.

EPOXY REINF. STEEL

BAR	LOCATION	SHAPE	NO.	LENGTH	WEIGHT
5e1	HORIZONTAL	112	10-0	5.693	
5e2	HORIZONTAL	224	5'-4	5.693	
5f1	VERTICAL	88	12'-6	13.708	
TOTAL (LBS)					47,936

CONCRETE PLACEMENT SUMMARY

SECTION	TOTAL
WING WALL	19.3
TOTAL (CU. YD.)	19.3

WING WALL DETAILS

ALL MATERIAL AND DIMENSIONS ARE ESTIMATES FOR PRELIMINARY DESIGN AND SHOULD NOT BE USED WITHOUT VERIFICATION IN FINAL DESIGN OF THIS PROJECT. ALL DESIGNS ARE CONSIDERED PRELIMINARY AND FOR EDUCATIONAL PURPOSES ONLY.
WING WALL IS TO BE PLACED SEPARATE FROM THE BRIDGE ABUTMENT AND WILL BE CAST IN PLACE CONCRETE. WING WALLS WILL BE ATTACHED TO THE BEARING/RETAINING WALL AND FOUNDATION THROUGH DOWEL REINFORCEMENT AS DETAILED IN THE RETAINING WALL DESIGNS SHEETS.
REINFORCING IS TO BE CUT TO LENGTH AND BENT BASED FROM STANDARD DIMENSIONS SHOWN IN REINFORCING STEEL SUMMARY. CLEAR COVER OF ALL REINFORCING STEEL TO BE 2" UNLESS OTHERWISE SPECIFIED IN THIS PLAN SHEET.
SCOUR PROTECTION IS CLASS E REVENEMENT UNDERLAIN WITH ENGINEERING FABRIC AS SPECIFIED IN THE HYDRAULIC ANALYSIS DESIGN REPORT. REVENEMENT SIZING TO BE SPECIFIED LATER.

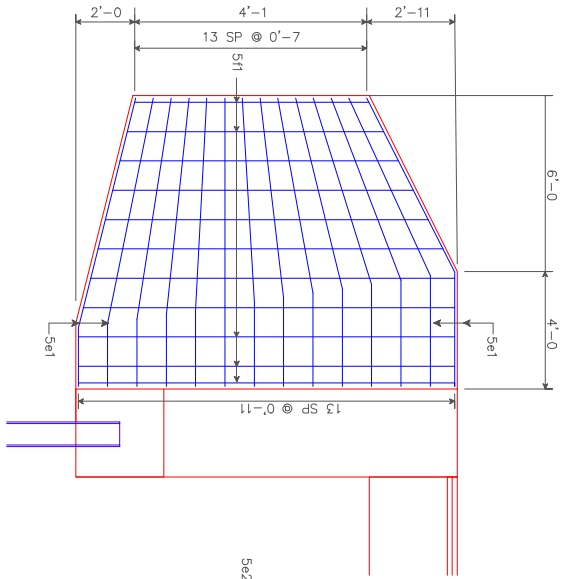

WING WALL ELEVATION VIEW

WING WALL DETAILING (TYP.)

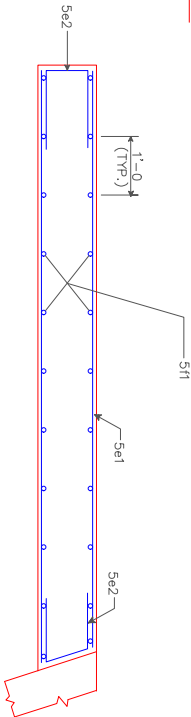

DESIGN FOR 0° SKEW
75'-0" x 40'-0"
 HYBRID COMPOSITE BEAM BRIDGE
 SINGLE SPAN BRIDGE

WING WALL DETAILS
 STATION 28+42.18 = CENTERLINE, 12TH ST. BRIDGE
CERRO GORDO COUNTY
 MAY 2017

CITY OF MASON CITY
 DESIGN SHEET NO. ___ OF ___ FILE NO. ___ DESIGN NO. ___

PROJECT: CEE: 3084: 0001

DATE : 5/5/17

DRAWN BY: ZRG

REVISION:

THE UNIVERSITY OF IOWA
CIVIL AND ENVIRONMENTAL ENGINEERING

4105 SEAMANS CENTER FOR THE
 ENGINEERING ARTS AND SCIENCES
 103 S CAPITOL ST
 IOWA CITY, IOWA 52242
 PHONE: 319.335.5642
 FAX: 319.335.5660
 EMAIL: civil-hawks@uiowa.edu



EDUCATIONAL, NOT
 PROFESSIONAL

BRIDGE AND BIKEWAY

12TH STREET OVER WILLOW CREEK
 MASON CITY, IA 50402

SHEET NAME

SHEET NO.

V13

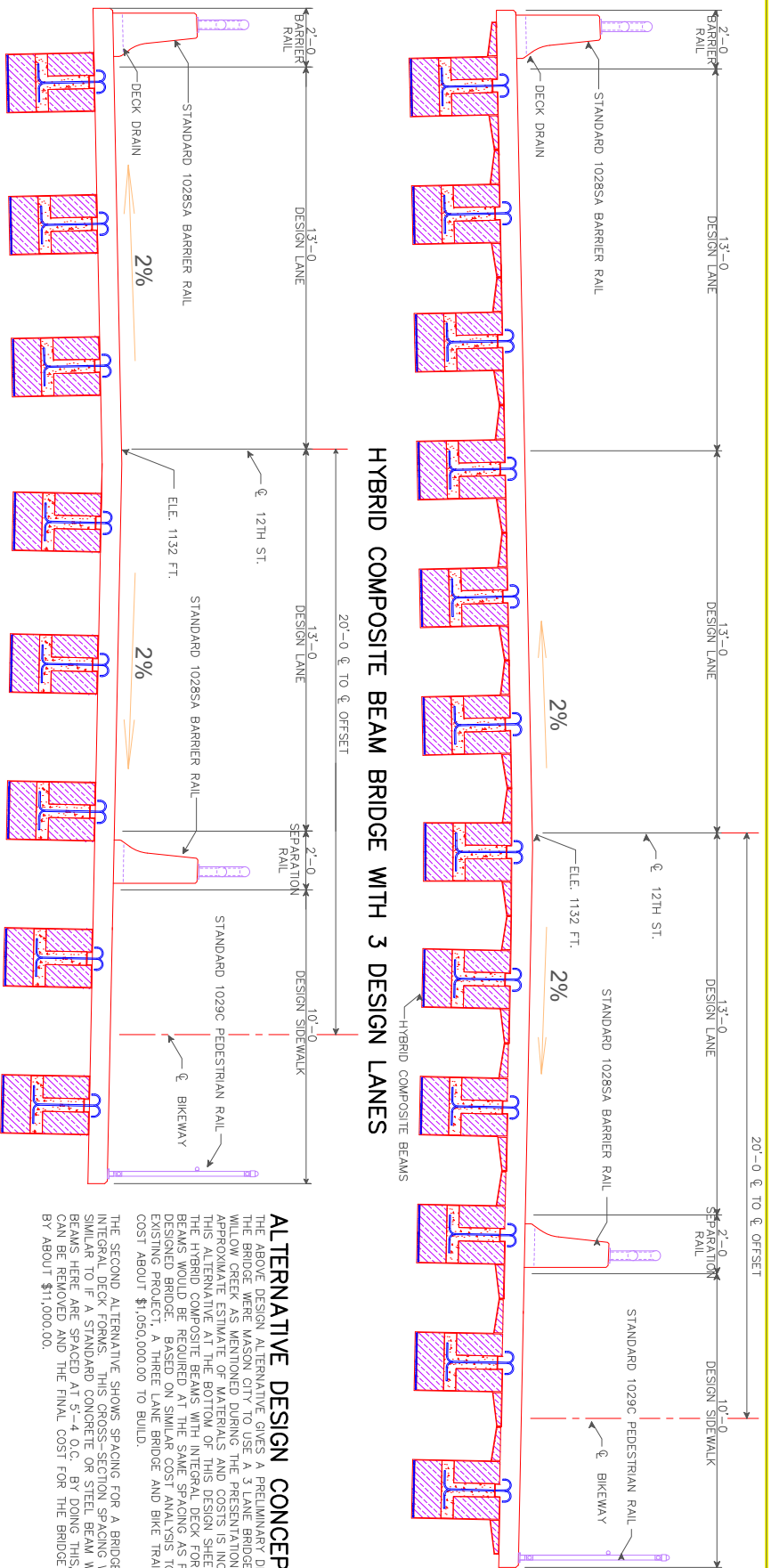

HYBRID COMPOSITE BEAM BRIDGE WITHOUT INTEGRAL DECK FORM
TOTAL ESTIMATED PROJECT QUANTITIES

ITEM NO.	ITEM	UNIT	QUANTITIES		ITEM NO.	ITEM	UNIT	QUANTITIES	
			ESTIMATED TOTAL	AS BUILT TOTAL				ESTIMATED TOTAL	AS BUILT TOTAL
1	STANDARD PAVEMENT CONCRETE	CY	293.6		19	18" CULVERT	UNIT	40	
2	STRUCTURAL CONCRETE	CY	253.8		20	8" CULVERT	UNIT	84	
3	ASPHALT PAVEMENT	CY	1,302		21	GUARD RAIL END TERMINAL	UNIT	2	
4	EPOXY COATED REBAR	LBS.	119,143		22	CLASS B REVENTMENT	TONS	75.6	
5	STAINLESS STEEL REBAR	LBS.	4,620		23	CLASS 10 EXCAVATION	CY	150	
6	STEEL PIPE HANDRAIL	LF	150		24	BRIDGE REMOVAL	LUMP		
7	HYBRID COMPOSITE BEAMS	LF	832		25	SAFETY CLOSURE	LUMP		
8	HP STEEL PILES	LF	1462		26	MOBILIZATION	LUMP		
9	BRG. 16" RIPRAP	TONS	100		27	SEEDING AND FERTILIZATION	ACRE	50	
10	BRIDGE ENGINEERING FABRIC	SF	400		28	SILT FENCE	LF	900	
11	BRIDGE BACKFILL MATERIAL	CY	200		29	SEDIMENT CONTROL	LUMP		
12	CHAIN LINK FENCE	LF	79.0		30	CLEARING AND GRUBBING	ACRE	5	
13	TRACTION PADS	UNIT	16		31	GRANULAR SHOULDER	SF	240	
14	PEDESTRIAN CROSS WALK SIGNS	UNIT	6		32	BANK SHAPING	SY	50	
15	MASON CITY BIKEWAY SIGNS	UNIT	16		33	PAVEMENT REMOVAL	LUMP		
16	PEDESTRIAN TRAIL CUT	CY	5,870		34	PAINTED PAVEMENT	STA.	4	
17	PEDESTRIAN TRAIL FILL	CY	7,254		35	BRIDGE SOIL COMPACTION	SY	175	
18	36" CULVERT	UNIT	40						

ALTERNATIVE DESIGN CONCEPTS:

THE ABOVE DESIGN ALTERNATIVE GIVES A PRELIMINARY DESIGN FOR THE BRIDGE WERE MASON CITY TO USE A 3 LANE BRIDGE ACROSS WILLOW CREEK AS MENTIONED DURING THE PRESENTATION. AN APPROXIMATE ESTIMATE OF MATERIALS AND COSTS IS INCLUDED FOR THIS ALTERNATIVE AT THE BOTTOM OF THIS DESIGN SHEET. USING THE HYBRID COMPOSITE BEAMS WITH INTEGRAL DECK FORMS, 12 BEAMS WOULD BE SPACED AT 5'-4" O.C. BASED ON THE DESIGN BRIDGE. BASED ON SIMILAR COST ANALYSIS TO THE EXISTING PROJECT A THREE LANE BRIDGE AND BIKE TRAIL WOULD COST ABOUT \$1,050,000.00 TO BUILD.

THE SECOND ALTERNATIVE SHOWS SPACING FOR A BRIDGE WITHOUT INTEGRAL DECK FORMS. THIS CROSS-SECTION SPACING WOULD BE SIMILAR TO IF A STANDARD CONCRETE OR STEEL BEAM WERE USED. BEAMS WERE SPACED AT 5'-4" O.C. BY DOING THIS, 1 BEAM CAN BE REMOVED AND THE FINAL COST FOR THE BRIDGE DECREASES BY ABOUT \$11,000.00.

DESIGN FOR 0° SKEW
75'-0" x 40'-0"
 HYBRID COMPOSITE BEAM BRIDGE
 SINGLE SPAN BRIDGE

ALTERNATIVE CONCEPT BRIDGE
 STATION 28+42.18 = CENTERLINE, 12TH ST. BRIDGE
CERRO GORDO COUNTY
 MAY 2017
 CITY OF MASON CITY
 DESIGN SHEET NO. ___ OF ___ FILE NO. ___ DESIGN NO. ___

 THE UNIVERSITY OF IOWA CIVIL AND ENVIRONMENTAL ENGINEERING	PROJECT: CEE: 3084: 0001 DATE: 5/5/17 DRAWN BY: ZRG REVISION:	BRIDGE AND BIKEWAY 12TH STREET OVER WILLOW CREEK MASON CITY, IA 50402
SHEET NO. V14	SHEET NAME BRIDGE AND BIKEWAY	EDUCATIONAL, NON-PROFIT ORGANIZATION

10.4. Permits

Joint Application Permit.....	79
Flood Plain Dev Permit.....	81
Flood Plain Design Info Request.....	83
Construction Permit Application.....	84

JOINT APPLICATION FORM FOR IOWA

ITEMS 1 AND 2 FOR AGENCY USE

1. Application Number

2. Date Received

3. and 4. (SEE SPECIAL INSTRUCTIONS) NAME, MAILING ADDRESS AND TELEPHONE NUMBERS

3a. Applicant's Name

Company Name (if any)

Address

City, State, Zip

Email Address

3b. Co-Applicant/Property Owner Name (if needed or if different from applicant)

Company Name (if any)

Address

City, State, Zip

Email Address

4. Authorized Agent (an agent is not required)

Company Name (if any)

Address

City, State, Zip

Email Address

Applicant's Phone Nos. w/area code

Business:

Residence:

Cell:

Fax:

Applicant's Phone Nos. w/area code

Business:

Residence:

Cell:

Fax:

Agent's Phone Nos. w/area code

Business:

Residence:

Cell:

Fax:

5. ADJOINING PROPERTY OWNERS (Upstream and Downstream of the water body)

Name	Mailing Address	Phone No. w/area code
1.		
2.		
3.		

6. PROJECT TITLE:

7. PROJECT DESCRIPTION (Include all features):

8. PURPOSE AND NEED OF PROJECT:

More information on the Iowa Department of Natural Resources Flood Plain Management Program can be found on our website at: <http://floodplain.iowadnr.gov/> or by calling 866-849-0321.

COMPLETE THE FOLLOWING FOUR BLOCKS IF DREDGED AND/OR FILL MATERIAL IS TO BE DISCHARGED

9. REASON(S) FOR DISCHARGE:

10. TYPE(S) OF MATERIAL BEING DISCHARGED AND THE AMOUNT OF EACH TYPE IN CUBIC YARDS:
 TYPE:

 AMOUNT IN CUBIC YARDS:

11. SURFACE AREA IN ACRES OF WETLANDS OR OTHER WATERS FILLED, AND STREAM LENGTH IF APPLICABLE (See Instructions)

12. DESCRIPTION OF AVOIDANCE, MINIMIZATION AND COMPENSATION (See instructions)

13. PROJECT LOCATION

LATITUDE: LONGITUDE:	GIS Coordinates in NAD 1983 UTM Zone 15 Northing: Easting:				
STREET, ROAD, OR OTHER DESCRIPTIVE LOCATION	LEGAL DESCR	QUARTER	SECTION	TOWNSHIP NO.	RANGE
<input type="checkbox"/> IN OR <input type="checkbox"/> NEAR CITY OR TOWN (check appropriate box)	WATERWAY			RIVER MILE (if applicable)	
Municipality Name COUNTY	STATE	ZIP CODE			

14. Date activity is proposed to commence _____ Date activity is expected to be completed _____

15. Is any portion of the activity for which authorization is sought now complete? Yes No
 NOTE: If answer is "YES" give reasons in the Project Description and Remarks section.

 Month and Year the activity was completed _____ Indicate the existing work on drawings.

16. List all approvals or certification and denials received from other Federal, interstate, state, or local agencies for structures, construction, discharges or other activities described in this application.

<u>Issuing Agency</u>	<u>Type of Approval</u>	<u>Identification No.</u>	<u>Date of Application</u>	<u>Date of Approval</u>	<u>Date of Denial</u>

17. CONSENT TO ENTER PROPERTY LISTED IN PART 13 ABOVE IS HEREBY GRANTED. Yes No

18. APPLICATION VERIFICATION (SEE SPECIAL INSTRUCTIONS)
 Application is hereby made for the activities described herein. I certify that I am familiar with the information contained in the application, and that to the best of my knowledge and belief, such information is true, complete, and accurate. I further certify that I possess the authority to undertake the proposed activities.

Signature of Applicant or Authorized Agent	Date
Signature of Applicant or Authorized Agent	Date
Signature of Applicant or Authorized Agent	Date

Attach a Location Map and Construction Plans to this application before sending one (1) copy to: US Army Corp of Engineers, Clock Tower Building, PO Box 2004, Rock Island IL 61204; and two (2) copies to: Iowa DNR, Flood Plain & Sovereign Lands Sections, 502 E 9th St, Des Moines IA 50319.

JOINT APPLICATION FORM FOR IOWA

ITEMS 1 AND 2 FOR AGENCY USE

1. Application Number

2. Date Received

3. and 4. (SEE SPECIAL INSTRUCTIONS) NAME, MAILING ADDRESS AND TELEPHONE NUMBERS

3a. Applicant's Name

Company Name (if any)

Address

City, State, Zip

Email Address

3b. Co-Applicant/Property Owner Name (if needed or if different from applicant)

Company Name (if any)

Address

City, State, Zip

Email Address

4. Authorized Agent (an agent is not required)

Company Name (if any)

Address

City, State, Zip

Email Address

Applicant's Phone Nos. w/area code

Business:

Residence:

Cell:

Fax:

Applicant's Phone Nos. w/area code

Business:

Residence:

Cell:

Fax:

Agent's Phone Nos. w/area code

Business:

Residence:

Cell:

Fax:

5. ADJOINING PROPERTY OWNERS (Upstream and Downstream of the water body)

Name	Mailing Address	Phone No. w/area code
1.		
2.		
3.		

6. PROJECT TITLE:

7. PROJECT DESCRIPTION (Include all features):

8. PURPOSE AND NEED OF PROJECT:

More information on the Iowa Department of Natural Resources Flood Plain Management Program can be found on our website at: <http://floodplain.iowadnr.gov/> or by calling 866-849-0321.

COMPLETE THE FOLLOWING FOUR BLOCKS IF DREDGED AND/OR FILL MATERIAL IS TO BE DISCHARGED

9. REASON(S) FOR DISCHARGE:

10. TYPE(S) OF MATERIAL BEING DISCHARGED AND THE AMOUNT OF EACH TYPE IN CUBIC YARDS:
 TYPE:

 AMOUNT IN CUBIC YARDS:

11. SURFACE AREA IN ACRES OF WETLANDS OR OTHER WATERS FILLED, AND STREAM LENGTH IF APPLICABLE (See Instructions)

12. DESCRIPTION OF AVOIDANCE, MINIMIZATION AND COMPENSATION (See instructions)

13. PROJECT LOCATION

LATITUDE: LONGITUDE:	GIS Coordinates in NAD 1983 UTM Zone 15 Northing: Easting:				
STREET, ROAD, OR OTHER DESCRIPTIVE LOCATION	LEGAL DESCR	QUARTER	SECTION	TOWNSHIP NO.	RANGE
<input type="checkbox"/> IN OR <input type="checkbox"/> NEAR CITY OR TOWN (check appropriate box) Municipality Name COUNTY		WATERWAY			RIVER MILE (if applicable)
	STATE	ZIP CODE			

14. Date activity is proposed to commence _____ Date activity is expected to be completed _____

15. Is any portion of the activity for which authorization is sought now complete? Yes No
 NOTE: If answer is "YES" give reasons in the Project Description and Remarks section.

 Month and Year the activity was completed _____ Indicate the existing work on drawings.

16. List all approvals or certification and denials received from other Federal, interstate, state, or local agencies for structures, construction, discharges or other activities described in this application.

<u>Issuing Agency</u>	<u>Type of Approval</u>	<u>Identification No.</u>	<u>Date of Application</u>	<u>Date of Approval</u>	<u>Date of Denial</u>

17. CONSENT TO ENTER PROPERTY LISTED IN PART 13 ABOVE IS HEREBY GRANTED. Yes No

18. APPLICATION VERIFICATION (SEE SPECIAL INSTRUCTIONS)
 Application is hereby made for the activities described herein. I certify that I am familiar with the information contained in the application, and that to the best of my knowledge and belief, such information is true, complete, and accurate. I further certify that I possess the authority to undertake the proposed activities.

_____	_____
Signature of Applicant or Authorized Agent	Date
_____	_____
Signature of Applicant or Authorized Agent	Date
_____	_____
Signature of Applicant or Authorized Agent	Date

Attach a Location Map and Construction Plans to this application before sending one (1) copy to: US Army Corp of Engineers, Clock Tower Building, PO Box 2004, Rock Island IL 61204; and two (2) copies to: Iowa DNR, Flood Plain & Sovereign Lands Sections, 502 E 9th St, Des Moines IA 50319.



Iowa Department of Natural Resources
Flood Plain Management Program

Request for Base Floodplain Elevations, Offsets, and Design Parameters

Email completed form to: BFERequest@dnr.iowa.gov

I am requesting:

- Base Flood Elevation (BFE) and Minimum Protection Level (MPL)
Floodway Offset
Other (i.e. Flow Rate, Reach Slope) Explain:

Purpose of Request:

- BFE needed to apply for a Letter of Map Change or Letter of Map Amendment from FEMA.
BFE, MPL and/or Offsets needed for project design. A Joint Application will be submitted separately.
Other -Explain:

Site Information:

Owner Name:

Location (in Quarter-Section-Tier-Range format): Qtr. Sec. T N R

County: Stream(s):

Location Address/City/Zip Code (if available):

Project Description and Explanation of Request:

Empty box for project description and explanation of request.

Required information must be attached with this request form.

- Aerial photo clearly identifying the project location. Hand marked aerial photos are typically accepted. Aerial photos can be obtained from the following sources:

http://ortho.gis.iastate.edu/ http://programs.iowadnr.gov/maps/floodplain/
http://iowaassessors.com/ http://www.bing.com/mapspreview
https://beaconbeta.schneidercorp.com/ https://www.google.com/maps

Contact Information: Preferred Mailing Address (applicant or agent)

Name: Phone:

Address:

City/State/Zip:

Email Address (if available):

Land Owner Contact Information (if different from Contact Information)

Name: Phone:

Address:

City/State/Zip:

Email Address (if available):



DNR USE ONLY	
Initials: _____	Date: _____
<input type="checkbox"/> Check/Money Order <input type="checkbox"/> Credit Card <input type="checkbox"/> Cash	
Facility ID: _____	Project #: _____
<input type="checkbox"/> Initial Payment <input type="checkbox"/> Additional Payment	

FORM AF: CONSTRUCTION PERMIT APPLICATION FEE

Please see instructions on reverse side.

Company Name: _____ Facility Number (if known): _____
 Equipment Address: _____ City: _____

1. Payment Information

Billing Contact Name*: _____ Billing Phone Number: _____

*The person to contact regarding fee payment or billing for this project.

Billing Contact Email Address: _____

Company Name: _____

Billing Address: _____

City: _____ State: _____ Zip Code: _____

2. Facility Classification

- Minor Facility** The facility is **MINOR** if the DNR AQB has identified the facility as a minor source for the Title V operating permit program in previous permits; or if the application is for a permit template. **MINOR facilities should complete Sections 1, 2 and 3 of this form.**
- Major Facility** The facility is **MAJOR** if does not fall within the above category, is a new facility, or an existing facility without air quality construction permits. **MAJOR facilities should complete Sections 1, 2 and 4 of this form.**

3. Fee Determination: MINOR FACILITY

If selected Minor Facility above, enter the number of construction permit applications being submitted:

a. Minor Construction Permit Application(s): _____ x \$385 = \$ _____

or

b. Permit Template(s)**: _____ x \$100 = \$ _____

**View available permit templates at www.iowadnr.gov/airconstructionpermits

Total Fee Due \$ _____

Check a box for your selected payment method (see the instructions for additional payment information):

- Fee Enclosed - check, money order, or cash (do not send cash in the mail)
 Contact for Credit Card Payment or if you are a State Agency

4. Fee Payment Agreement: MAJOR FACILITY

If selected Major Facility above: by signing on the line provided below, the applicant agrees to be billed for all fees incurred for the review of your application at the applicable hourly rate. The applicant agrees that the applicant is liable for application fees based on the current Fee Schedule.

Signature: _____ Date: _____

Instructions for Form AF: Construction Permit Application Fee

- Complete one (1) Form AF for each application submission, plant-wide applicability limit request, or regulatory applicability determination.
- This form identifies the fee required for the review of your application.

Understanding Form AF: Each number provides an explanation for the corresponding field on the form.

Company Name: Name of the company or organization applying for the permit.

Facility Number: If known, provide the facility number assigned by the Department, if you do not know your facility number, you may leave this question blank.

Equipment Address and City: Provide the address where the equipment will be or is already installed. If equipment is portable use the staging area address.

1. Payment Information:

Provide the name and contact information for the person within the company who should be contacted regarding billing and invoicing. For major facilities, this is also the person to whom the billing invoice will be emailed. Please note this contact may be different than the Project Contact listed on the Form FI.

2. Facility Classification:

Indicate whether the facility is major or minor source for the Title V operating permit program. A facility's status may be determined by checking the DNR's State & Local Emission Inventory System (SLEIS) database. The facility status should be checked before every submittal. After establishing a user account in SLEIS, follow the steps below to check your status:

1. Log into SLEIS at <https://programs.iowadnr.gov/sleis/>
2. Select the open button under the "Actions" column (right side of screen) for the appropriate facility.
3. Select the open button under the "Actions" column (right side of screen) for the most recent year.
4. On the emission inventory reporting screen select "facility".
5. On the "General Facility Information" screen, select the "Facility" tab; toward the bottom there is a listing for "Status" which indicates whether the facility is major or minor.

If the application is for a **new facility** or an **existing facility without air quality construction permits** then check the "Major Facility" box. If necessary, please contact the Iowa DNR AQB Hotline (1-877-247-4692) to discuss source classification.

3. Fee Determination: Minor Facility:

This section should be completed if you selected that your facility is a minor facility in Section 2. Enter the number of permit applications you are submitting for each minor source construction permit or a permit template you are requesting. The number of applications corresponds to the number of permits or emission points you are requesting. Enter the number of applications into the appropriate category and calculate the total payment due. If additional applications are required to complete the project the DNR will contact the facility for additional payment. Under this scenario a new Form AF will be required and should reflect only the additional permit(s) not listed on the original form.

Permit Templates include applications with predetermined operating conditions and limitations such as Group 2 Grain Elevators, Concrete Batch Plants, Hot Mix Asphalt Plants or Bulk Gasoline Plants. All available permit templates can be found at www.iowadnr.gov/airconstructionpermits.

Payment is due at the time the application is submitted and can be made by:

- **Cash** - payment can be made in person at the DNR Air Quality Bureau offices located at 7900 Hickman Rd Ste 1, Windsor Heights IA during business hours (Monday - Friday, 8am to 4:30pm).
- **Checks or Money Orders** - make payable to: Iowa Department of Natural Resources, and include the check or money order payment with this form.
- **Credit card** - (Visa, MasterCard, or Discover) - the DNR will contact the person identified in Section 1 to complete payment of the application fees.
- **State Agency** - The DNR will contact the person identified in Section 1 to complete payment of the application fees.

The application will not be assigned a Project Number for engineering review until payment is received.

4. Fee Payment Agreement: Major Facility:

This section should be completed if you selected that your facility is a major facility in Section 2. Please sign the confirmation that application fees are required based on the current Fee Schedule. Construction permit application fees, plant-wide applicability limit requests, and regulatory applicability determinations for major sources are based on the number of hours worked to process your application. Major source fees are billed to the facility in an invoice. The invoice amount is based on the hours spent reviewing the application and the staff's hourly rates per the "Fee Schedule" available at www.iowadnr.gov/aqfees.

Signature and Date: The application will not be assigned a Project Number for engineering review until a signed Form AF is received.

UNIVERSITY OF IOWA
DEPARTMENT OF CIVIL & ENVIRONMENTAL ENGINEERING
Project Design & Management
CEE:3084:0001

RFP # 05-spr2017

Bridge and Bikeway

RFP Coordinator: Professor Paul Hanley
4123 Seamans Center

Tel: 319 335-8137 e-mail: paul-hanley@uiowa.edu

From the time this RFP is issued until award notification is made, all contact regarding this RFP must be made through the aforementioned RFP Coordinator. No other person is empowered to make binding statements regarding this RFP. Violation of this provision may lead to disqualification from the bidding process, at the coordinator's discretion.

Bidders' Conference: TBD, 2015, 12:30, 350 VAN

Deadline for Submitted Questions: February 1, 2017, 5:00 p.m. local time

Proposals and Presentation Due: February 3, 2017, not later than 12:30 p.m. local time

Submit to:

ICON Drop box

Project Design & Management (CEE:3084:0001) - RFP is for educational purposes only 2

Public Notice

**UNIVERSITY OF IOWA
DEPARTMENT OF CIVIL & ENVIRONMENTAL ENGINEERING
Project Design & Management (CEE:3084:0001)**

**Public Notice for RFP# 05-spr2017
Bridge and Bikeway**

The Instructors of Project Design & Management (CEE:3084:0001), University Of Iowa, Department of Civil & Environmental Engineering has a requirement for engineering services for the evaluation and design of civil infrastructure. In accordance with procurement practices, the Instructors are hereby announcing the publication of a Request for Proposals (RFP) #05spr2017 for the purchase of the aforementioned services.

A copy of the RFP can be obtained by contacting the Department’s RFP Coordinator for this project: Paul Hanley – Associate Professor. The RFP Coordinator can be reached at the following email address: paul-hanley@uiowa.edu or mailing address: 4123 Seamans Center. The Department encourages all interested vendors to obtain a copy of the RFP and submit a competitive proposal.

Proposals must be submitted to the Instructors (electronic submission to ICON). Proposals must be submitted by 12:30 pm, local time, on February 3, 2017, when they will be opened by the Instructors. Proposals not received in ICON by the aforementioned deadline will not be considered.

UNIVERSITY OF IOWA
DEPARTMENT OF CIVIL & ENVIRONMENTAL ENGINEERING
Project Design & Management (CEE:3084:0001)
RFP# 05-spr2017
Bridge and Bikeway

PART I INTRODUCTION

A. Purpose and Background

The Project Design & Management (CEE:3084:0001) Instructors (Instructors) of the Department of Civil & Environmental Engineering (Department) is seeking proposals to provide engineering services as defined in this Request for Proposals (RFP) document. This document provides instructions for submitting proposals, the procedure and criteria by which the Provider(s) will be selected, and the terms which will govern the relationship between the Instructors and the awarded Bidder.

As part of the Senior Design Capstone Course, the Instructors have the need for the design of a bike trail extension and a multimodal bridge for the City of Mason City, IA. Work tasks include the design of a bikeway paralleling an existing rural road and span a creek with a multimodal bridge and a project cost estimate. The 71' span bridge design will include additional width to accommodate a 10' trail. The bridge portion of the project will require a complete hydrological report and meet all of the requirements for Iowa DNR approval. The designers of the bridge should also give consideration to alternate materials and methods that reduce maintenance costs but still provide an acceptable structure life-cycle.

B. General Provisions

1. Issuance of this RFP does not commit the Department to issue an award or to pay expenses incurred by a Bidder in the preparation of a response to this RFP. This includes attendance at personal interviews or other meetings and software or system demonstrations, where applicable.
2. All proposals should adhere to the instructions and format requirements outlined in this RFP and all written supplements and amendments (such as the Summary of Questions and Answers), issued by the Instructors. Proposals are to follow the format and respond to all questions and instructions specified below in the "Proposal Submission Requirements and Evaluation" section of this RFP.
3. Bidders shall take careful note that in evaluating a proposal submitted in response to this RFP, the Instructors will consider materials provided in the proposal, information obtained through interviews/presentations (if any), and internal Departmental information. The Instructors also reserves the right to consider other reliable references and publicly available information available in evaluating a Bidder's experience and capabilities. The proposal shall be signed by a person authorized to bind the Bidder and shall contain a statement that the proposal and the pricing contained therein will remain valid and binding for a period of 180 days from the date and time of the bid opening.

Project Design & Management (CEE:3084:0001) - RFP is for educational purposes only 4

4. The RFP and the selected Bidder's proposal, including all appendices or attachments, will be incorporated in the final contract.
5. Following announcement of an award decision, all submissions in response to this RFP will be considered records available for inspection by faculty and students. In the event a request is made to produce any proposal, the Instructors will faithfully attempt to notify the bidder that the Instructors will produce the proposal. The Instructors will not undertake to determine whether any proposal or part of any proposal is confidential or otherwise protected from disclosure.
6. The Instructors, at their sole discretion, reserves the right to recognize and waive minor informalities and irregularities found in proposals received in response to this RFP.
7. The Instructors reserve the right to authorize others to use the results from this RFP, if it is deemed to be beneficial for the Department to do so.
8. All applicable rule and regulations, whether or not herein contained, shall be included by this reference. It shall be Bidders' responsibility to determine the applicability and requirements of any such rules and regulations and to abide by them.

C. Eligibility to Submit Bids

University of Iowa, Civil & Environmental Engineering undergraduate students enrolled in the Project Design & Management Course (CEE:3084:0001) are invited to submit bids in response to this Request for Proposals.

D. Contract Term

The Instructors are seeking a cost-efficient proposal to provide services, as defined in this RFP, for the anticipated period defined in the table below. Please note that the dates below are estimated and may be adjusted as necessary in order to comply with all procedural requirements associated with this RFP and the Department process. The actual contract start date will be established by a completed and approved final proposal.

The term of the anticipated proposal, resulting from this RFP, is defined as follows:

Period	Start Date	End Date
Initial Period of Performance	2/06/2017	5/05/2017

E. Number of Awards

The Instructors anticipates making one award as a result of this RFP process.

PART II SCOPE OF SERVICES TO BE PROVIDED

TASK 1 – PROJECT KICKOFF AND DATA COLLECTION

1. Generate a written summary of the team’s understanding of the project and tentative listing of team roles prior to meeting with the Client.
2. Prepare a written background summary of similar projects, which should include descriptions of similar projects completed by consulting engineering firms, departments or agencies, government documents and studies, relevant design standards, textbook references, and professional publications prior to meeting with the Client.
3. Conduct several team meetings to generate lists of materials, data, plans, studies, and other information the team believes are relevant to the RFP process prior to contacting the Client. Examples of information include aerial mapping, existing development plans, traffic studies, hydrology/hydraulic reports, water lines, storm and sanitary sewer line location and size, and other data.
4. Conduct a project kickoff meeting with the Client via phone, video-link or in-person with a written agenda to review project scope, procedures for the transmittal of the information identified in Task 1.3. Minutes of meeting must be prepared and delivered to the Client and RFP Coordinator.

TASK 2 – FIELD ASSESSMENT AND CONCEPT DEVELOPMENT

1. Conduct several team meetings to generate guiding conceptual design approaches – three (3) alternative concept designs are required in response to this RFP.
2. Conduct a field walk-through assessment of the area with the Client to determine extent and nature of known problems. Document the walk-through with photographs and note constraints and challenges of the project site. Discuss potential solutions with the Client during the walkthrough. It is anticipated that the field walk-through will be attended by at least the Project Manager. If the walk-through cannot be completed prior to the proposal submission then it should occur as close to the submission date as feasible.

TASK 3 –DESIGN DEVELOPMENT

1. Utilizing notes from the field walk-through and work sessions develop approximate assessment of the conditions to confirm or determine extents of the problems and potential solutions.
2. Develop conceptual drawings/sketches and other material to illustrate the alternatives. Three (3) conceptual design alternatives will be required.
3. Develop an evaluation tool to assist the Client in choosing the preferred design from the three (3) alternatives. A decision matrix is an acceptable tool if it includes a discussion of weighting based on a summary of the advantages/disadvantages, constructability, utility conflicts/coordination, easement and right-of-way needs, personal property impacts, environment changes, sustainability and other criteria proposed.
4. Conduct a review meeting with the Client to review and select the preferred design from the three (3) alternatives.
5. Refine the calculations from Task 3.1 for use in the preferred design.
6. Prepare of design sheets that include appropriate plan and cross-section drawings and notes. The drawings must be of such detail and size to clearly convey the elements of the design selected by your firm and Client (the preferred design of the three (3) design alternatives).

Project Design & Management (CEE:3084:0001) - RFP is for educational purposes only

7. Prepare of a List of Materials including quantities and when needed the manufacturer for estimating the total project cost.
8. Revise DRAFT design reports based on Client and Instructor comments and directives.
9. Submit a FINAL design report to the Instructors in electronic format (PDF is acceptable) and to the Client in a format chosen by the Client.
10. Present the final design report to the Client, Instructors, and Department.

TASK 4 – PROJECT MANAGEMENT AND COORDINATION

1. Administration and Coordination.
 - a. Perform duties necessary for administration of project contract. Prepare and administer project expenses.
2. General communication with the Client and Instructors.
 - a. This includes email updates, phone conversations, and general correspondence weekly with the Instructors and approximately a bi-weekly basis with the Client during the course of the project.
3. Documentation of work-to-date
 - a. Each project team member must submit in writing the work tasks completed for the week, the tasks to be completed in the coming week and the number of hours worked.

ADDITIONAL SERVICES (NOT INCLUDED)

If authorized by the Client, the engineering firm will provide services in addition to those previously stated. This work will only proceed upon written authorization from the Client. For instance, this may include additional alternatives to be investigated, additional meetings not stated previously, or final design, advertising and bidding, award and construction phase services.

PART III KEY RFP EVENTS

A. Timeline of Key RFP Events

Event Name	Event Date and Time
Bidders' Conference	TBD (1/18 through 2/3) at 12:30pm, local time
Due Date for Receipt of Written Questions	2/01/2017 at 5:00pm, local time
Due Date for Receipt of Proposals and Presentation	2/03/2017 at 12:30pm, local time
Estimated Contract Start Date (subject to change)	2/06/2017 at 1:30pm, local time

B. Bidders Conference

The Department will sponsor a Bidders' Conference concerning this RFP beginning at the date and time shown in the timeline above. The Bidders' Conference will be held at 350 VAN

The purpose of the Bidders' Conference is to answer and/or field questions, clarify for potential Bidders any aspect of the RFP requirements that may be necessary and provide supplemental information to assist potential Bidders in submitting responses to the RFP.

C. Questions

1. General Instructions

- a. It is the responsibility of each Bidder to examine the entire RFP and to seek clarification in writing if the Bidder does not understand any information or instructions.
- b. Questions regarding the RFP must be submitted in writing and received by the RFP Coordinator listed on the cover page of this RFP document as soon as possible but no later than the date and time specified in the timeline above.
- c. Questions may be submitted by email. The Department assumes no liability for assuring accurate/complete on email transmission and receipt.
- d. Include a heading with the RFP Number and Title. Be sure to refer to the page number and paragraph within this RFP relevant to the question presented for clarification, if applicable.

2. Summary of Questions and Answers

Responses to all substantive and relevant questions will be compiled in writing and distributed to all registered, interested persons by e-mail no later than three (3) calendar days prior to the proposal due date. Only those answers issued in writing by the RFP Coordinator will be considered binding. The Department reserves the right to answer or not answer any question received.

D. Submitting the Proposal

1. **Proposals due:** Proposals must be received no later than 12:30 p.m. local time, on the date listed in the timeline above, at which point they will be opened. Proposals received after the 12:30 p.m. deadline will be rejected without exception.

2. Delivery Instructions

PLEASE NOTE: The proposals are to be submitted to the RFP Coordinator at the requesting Department. The official delivery site is the Project Design & Management class ICON site.

- a. Only proposals received at the official delivery site prior to the stated deadline will be considered. Bidders submitting proposals are responsible for allowing adequate time for delivery. Proposals received after the 12:30 p.m. deadline will be rejected without exception.
- b. The Bidder must send its proposal and attachments in MS Word format. Any attachments that cannot be submitted in MS Word format may be submitted as Adobe (.pdf) files.

Contact

Mark A. Rahm, P.E.

City Engineer

City of Mason City

10 1st Street NW Mason City, IA 50401

Office: (641) 421-3605 | Fax: (641) 421-3607

mrahm@masoncity.net | www.masoncity.net

Work products:

Site design is to be completed in Civil 3D. The design is to be generated and shown in plan and cross section views and rendered in 3D. The final plan drawings are to be used to generate a plan set that is printable both electronically and on paper*.

The design shall include as a minimum the following elements:

- Site Location

- Construction boundaries

- Existing and future utilities location

- Existing and final grading (cut and fill requirements)

Bridge structure design is to follow applicable AASHTO standards and the Iowa DOT LRFD Design Manual (<http://www.iowadot.gov/bridge/manuallrfd.htm>). The design is to be completed in AutoCAD utilizing Robot Structural Analysis extension (or comparable software). The design is to be shown in plan and cross section views and rendered in 3D. The rendering shall be created using AutoCAD Revit (3D Max or comparable software). The final plan drawings are to be used to generate a plan set that is printable both electronically and on paper*.

The design may include as a minimum the following elements:

- Hydraulic analysis of stream channel

- Deck

- Haunch

- Girder

- Slab

- Bearings

- Railing

- Pedestrian facilities

- Expansion joints

- Deck

- Drains

- Piles, shafts, footing (when applicable)

- Abutments Piers (if applicable)

Pedestrian and bike trail design is to follow applicable Iowa DOT standards and ADA regulations and to be completed in AutoCAD Civil 3D. The design is to be shown in plan and cross section views and rendered in 3D. The rendering shall be created using AutoCAD Vehicle Tracking extension. The final plan drawings are to be used to generate a plan set that is printable both electronically and on paper*.

The design may include as a minimum the following elements:

- Horizontal alignment
- Vertical alignment
- Cross-sections
- Pavement material and thickness
- Cut and fill requirements
- Drainage

*Drawings

Drawing Size. All drawings of a single project must be a uniform standard size, as designated by the American National Standards Institute (ANSI). The following are related sheet sizes:

Related Sheet Sizes

- (A) 8.5" x 11" 220 mm x 280 mm
- (B) 11" x 17" 280 mm x 430 mm
- (C) 17" x 22" 430 mm x 560 mm
- (D) 22" x 34" 560 mm x 860 mm
- (E) 34" x 44" 860 mm x 1120 mm

Drawing Lettering. Lettering on drawings must be legible when drawings are reduced to half size and when they are printed as PDF. This applies to concept and design development drawings.

Drawing Scale. All drawings will be produced with metric drawing scales which are always expressed in nondimensional ratios. Scales should also be illustrated graphically on the drawings. Scale of drawings should be appropriate for high resolution and legibility to include half-size reduced copies.

There are nine preferred base scales: 1:1 (full size), 1:5, 1:10, 1:20, 1:50, 1:100, 1:200, 1:500, 1:1000. Three others have limited usage: 1:2 (half size), 1:25, 1:250. Floor plans should be drawn at 1:100 (close to 1/8-inch scale).

CAD Standards. The National CAD/CIFM Standards should be obtained via the internet. These guidelines should be followed for all CAD drawing formatting

Dimensioning. US Customary Units are the unit of measurement to appear on documents for building plans and details for all disciplines.

10.5. Calculations and Tables

PILE SIDE FRICTION CALCULATIONS WORKSHEET										
Project: _____										
By: _____										
Date: _____										
INPUT DATA										
Layer Data								Pile Geometry		
Sample Layer	ΔL (ft.)	N Value	η_r	ϕ' (deg)	E_s (psi)	c' (psi)		Pile Type	HP 10x42	
0	0.00	3.00	0.85	28.94	60000	1279		d_1 (in.)	9.990	
1	10.00	3.00	0.85	28.94	60000	1279				
2	20.00	3.00	0.95	27.75	60000	1279		d_2 (in.)	10.225	
3	30.00	3.00	0.95	27.75	60000	1279		w (in.)	0.420	
4	40.00	6.00	1.00	28.94	120000	2107		A_p (in.^2)	12.400	
5	50.00	6.00	1.00	28.94	120000	2107				
6	60.00	8.00	1.00	30.00	160000	2592				
7	70.00	8.00	1.00	28.94	160000	2592				
8	80.00	8.00	1.00	28.94	160000	2592				
9	90.00	8.00	1.00	28.94	160000	2592				
10	100.00	8.00	1.00	27.75	160000	2592		P_p (in.)	40.430	
SOIL OUTPUT DATA										
Sample Layer	D_{top} (ft.)	D_{bottom} (ft.)	ΔL (ft.)	N Value	η_r	σ'_{avg} (psf)	ϕ'	E_s (psi)	c' (psi)	
0	0.00	10.00	10.00	3	0.85	600	28.94	60000	0	
1	10.00	20.00	10.00	3	0.85	1825	28.94	60000	0	
2	20.00	30.00	10.00	3	0.95	3075	27.75	60000	0	
3	30.00	40.00	10.00	3	0.95	4325	27.75	60000	0	
4	40.00	50.00	10.00	6	1.00	5575	28.94	120000	0	
5	50.00	60.00	10.00	6	1.00	6825	28.94	120000	0	
6	60.00	70.00	10.00	8	1.00	8075	30.00	160000	0	
7	70.00	80.00	10.00	8	1.00	9325	28.94	160000	0	
8	80.00	90.00	10.00	8	1.00	10575	28.94	160000	0	
9	90.00	100.00	10.00	8	1.00	11825	28.94	160000	0	
10	100.00	110.00	10.00	8	1.00	13075	27.75	160000	0	
PILE SIDE FRICTION OUTPUT DATA										
Soil Layer	σ'_{avg} (psf)	K	f_i	f_{ave} (psf)	P_s (kip)					
1	2456.25	1.65	1733.288	1733.288	175.1921					
2	6200	1.65	4375.118	4375.118	294.8101					
3	10575	1.65	7462.4	7462.4	1257.103					
4		1.65	0							
Total P_s					1727.106					
Total P_p					0					

Figure 10.5.1: Calculations for foundation pile capacity

Lat. Pressure (Line Load)		Lat. Pressure (Strip Load)				Load Data (Line Load):		
z (ft.)	σ (psf)	z (ft.)	α (deg)	β (deg)	σ (psf)	q (plf)	H (ft.)	
1	0	0.00	1	0	90	0	0	2666.6667
2	1	134.88	2	1	87.4	7.95	25.34529	12
3	2	213.23	3	2	84.81	15.42	48.642	0.5
4	3	227.81	4	3	82.23	22.05	68.42484	
5	4	204.58	5	4	79.7	27.68	84.13075	
6	5	168.89	6	5	77.2	32.31	95.85866	
7	6	134.18	7	6	74.74	36.03	104.067	
8	7	105.14	8	7	72.35	38.96	109.341	
9	8	82.32	9	8	70.02	41.24	112.261	
10	9	64.81	10	9	67.75	42.99	113.3206	
11	10	51.49	11	10	65.56	44.29	112.9109	
12	11	41.33	12	11	63.43	45.25	111.3998	
13	12	33.52	13	12	61.39	45.91	109.0488	

Load Data (Strip Load):	
q (psf)	H (ft.)
144	12
6	6
32	32

Combined Earth Pressures		
z (ft.)	σ (psf)	
1	0	0.00
2	1	160.23
3	2	261.87
4	3	296.23
5	4	288.71
6	5	264.74
7	6	238.25
8	7	214.48
9	8	194.58
10	9	178.13
11	10	164.40
12	11	152.73
13	12	142.57

Average Surcharge (ksf)	
	215.8607

Horizontal Surcharge Pressure

Figure 10.5.2: Lateral loading for Wing Wall design.

Section:	Station Beginning	Station End	Length (ft)	Asphalt (yd ³)	Barrier Rail (yd3)	Driveway volume (yd ³)	Approach Concrete (yd3)
1	0+00.00	26+54.05	2654.05	491.49	0.00	0.00	
2	26+54.05	26+78.41	24.36		Existing Concrete		3.70
3	26+78.41	27+00.00	21.59	4.00	0.00	0.00	
4	27+00.00	30+31.45	331.45	61.38	69.83	0.00	
5	30+31.45	31+10.45	79		Bridge		
6	31+10.45	34+00.00	289.55	53.62	61.00		
7	34+00.00	35+24.39	124.39	23.04	0.00		
8	35+24.39	35+49.07	24.68		Existing Concrete		3.70
9	35+49.07	52+89.65	1740.58	322.33	0.00		
10	52+89.65	53+13.78	24.13		Existing Concrete		3.70
11	53+13.78	60+52.26	738.48	136.76	0.00		
12	60+52.26	60+75.75	23.49		Existing Concrete		3.70
13	60+75.75	64+08.03	332.28	61.53	0.00		
14	64+08.03	64+40.78	32.75	6.06	0.00	24.26	
15	64+40.78	75+49.29	1108.51	205.28	0.00		
16	75+49.29	75+73.62	24.33	4.51	0.00	18.02	
17	75+73.62	79+09.88	336.26	62.27	0.00		
18	79+09.88	79+29.77	19.89	3.68	0.00	14.73	
19	79+29.77	83+88.60	458.83	84.97	0.00		
20	83+88.60	84+40.00	51.4		Existing Concrete		3.70
21	84+40.00	90+68.55	628.55	116.40	0.00		
22	90+68.55	91+00.00	31.45		Existing Concrete		3.70
23	91+00.00	95+21.49	421.49	78.05	0.00		
24	95+21.49	95+61.79	40.3		Existing Concrete		3.70
25	95+61.79	96+42.50	80.71	14.95	0.00		
26	96+42.50	96+87.83	45.33		Existing Concrete		3.70
27	96+87.83	96+95.73	7.9	1.46	0.00		
Totals:			9695.73	1731.78	130.82	57.01	7.41

Figure 10.5.3: Bikeway material estimates.

Sections	
Section 1:	4th St NW to 12th St NW
Section 2:	12th St Crossing
Section 3:	North Side of 12th St Corner
Section 4:	Bike path conjoined w 12th St
Section 5:	River Crossing
Section 6:	Bike path conjoined w 12th St
Section 7:	Y split between bike path and 12th St
Section 8:	North Taft St Crossing
Section 9:	North Taft St. to ASSA ABLOY Wood Doors Driveway
Section 10:	ASSA ABLOY Wood Doors West Driveway
Section 11:	West Driveway to East Driveway
Section 12:	North Taft St. to ASSA ABLOY Wood Doors Driveway
Section 13:	ASSA ABLOY Wood Doors Driveway to
Section 14:	Utility Line Driveway
Section 15:	Utility Line Driveay to Indianhead Farms Inc. Driveway
Section 16:	Indianhead Farms Inc. Driveway
Section 17:	Indianhead Farms Inc. Driveway to Kraft Foods West Driveway
Section 18:	Kraft Foods West Driveway
Section 19:	Kraft Foods West Driveway to West Central Driveway
Section 20:	Kraft Foods West Central Driveway
Section 21:	Kraft Foods West Central Driveway to East Central Driveway
Section 22:	Kraft Foods East Central Driveway
Section 23:	Kraft Foods East Central Driveway to the East Driveway
Section 24:	Kraft Foods East Driveway
Section 25:	Kraft Foods East Driveway to 12th St
Section 26:	12th St Crossing
Section 27:	12th St to existing preexisting path

Figure 10.5.4: Supplemental information for bikeway



Preliminary Bridge Design

Cross Section Design Notes:

- 12'-0 design lane (x2)
- 4'-0 design shld (x2)
- 10'-0 pedestrian lane (x1)
- 1'-6 barrier rail (x2)
- see remainder of design calcs for component details

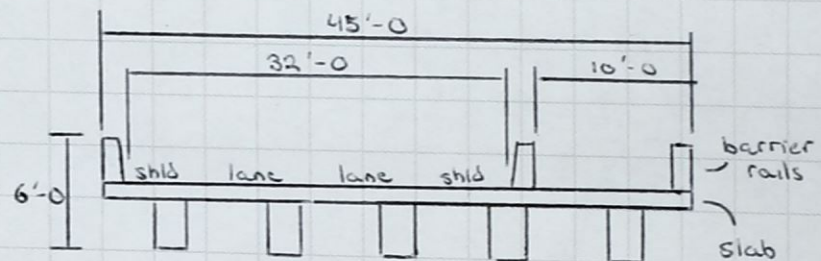

Bridge Deck Notes:

- traditional slab is 8" thick (do not meet requirements for pre-cast)
 - 2 layers of transverse/longitudinal reinforcement
 - #9 bars (long) and #6 bar (trans.) sp @ 5 in across deck
- use high performance (HPC) or improved durability (IDC) concrete (28 day, 4 ksi)
- 20 psf future wearing surface

Barrier Rails/Deck Drains:

- barrier rail must pass TL-4 standards
 - 34 in height for highway bridges
 - standard concrete barrier rail (~ 2.5 sq ft cross section)
 - alternative option railing
- separation rail requirements
 - 27-34 in high railing (car side) and 23⁺ in high (ped side)
 - 10 in thick railing w 12" sp #5 rebar
 - additional steel may be added
- exterior pedestrian rail; 54 in tall (bike requirement)
- deck drainage
 - maximum spacing = 50 ft
 - 4" x 8" galvanized tubes
 - min. of 15' from pier/abutment

1/4" Grid

Calcs/Notes/Assignment #

Name: Zachary Gerst

Title: Willow Creek Bridge Design

Date: 3/21/17

Pedestrian Facility Notes:

- 10'-0" minimum walkway width
- can be elevated above roadway
- ada requirements
 - maximum slope = 8% grade

Beam Design:

- about hillman composite beams
 - components; fiber reinforced shell, compression reinf. (conc.), tension reinf. (st.)
 - optimized use of materials (use structural filler foam for voids)
 - ↳ 1/10 weight of conc. beams
 - design for deflection (overdesigned strength)
 - uses 270 ksi tension steel / 6 ksi concrete

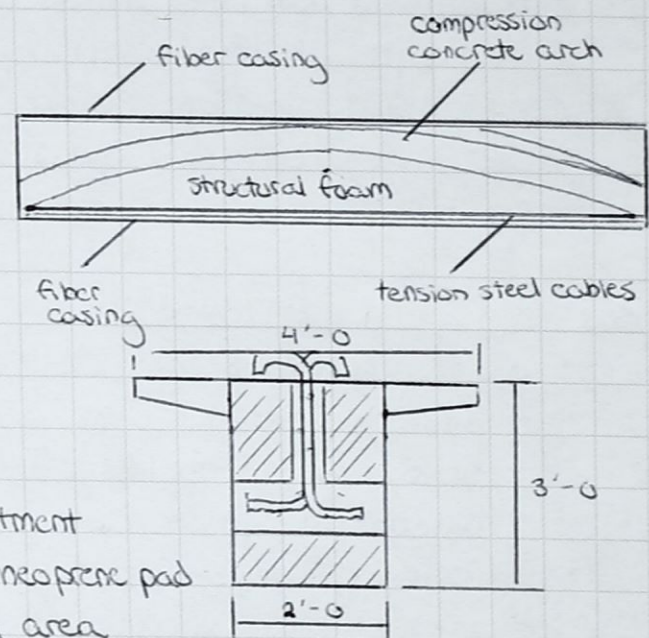

- preliminary beam selection
 - use HCB with integral deck forms (reduces construction time of slab)
 - beam depth = 36 in (5 in comp arch)
 - beam weight = 241 lb/ft
- bearing details / abutments
 - cast in several projects as an integral abutment
 - beam sits on 8" x 22" x 1/2" laminated neoprene pad
 - ↳ 3/4" rubber filler joint covers remaining area

- **adjust cross-section**; (2) 1'-6" barrier rails, (2) design lanes, (1) 10'-0" walkway
 - 10 beams required for construction
 - initial cost estimate of \$350/ft of beam

Substructure Design:



Pile Cap General Design:

- retaining wall / pile cap joined
- pile caps (precast) $\times 150$ kip

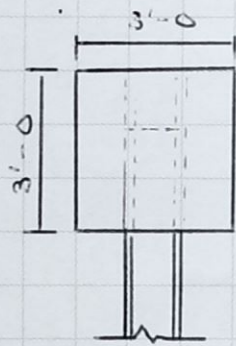

(pile cap \otimes)

- pile cap precast
- dim = $3' \times 3' \times 44'$
- weight = $57.4 = .15(3)(3)(44)$ kip

pile cap supports retaining wall and bridge

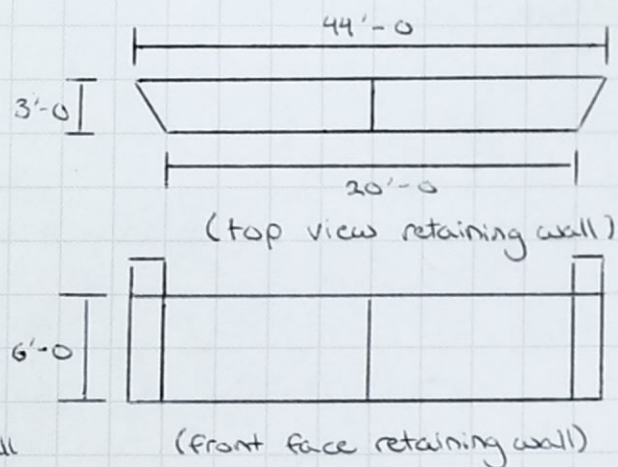

(top view retaining wall)

(front face retaining wall)

Pile Design:

Foundation Loads:

- Dead Load Components:

- concrete barrier rail ($\times 3$) $\rightarrow (3 \text{ ft}^2)(.15 \text{ kip/ft}^3)(3) = 1.35 \text{ KLF}$
 - 8" concrete slab $\rightarrow (8/12 \text{ ft})(40 \text{ ft})(.15 \text{ kip/ft}^3) = 4.00$
 - future wearing surface $\rightarrow (.02 \text{ ksf})(28 \text{ ft}) = 0.56$
 - sidewalk/ped. facility $\rightarrow (4/12 \text{ ft})(10 \text{ ft})(.15 \text{ kip/ft}^3) = 0.50$
 - hcb bridge beams ($\times 5$) $\rightarrow (.241 \text{ pLF})(10 \text{ beams}) = 2.41$
- DL = 8.82 KLF

- Live Load Components

- lane live loads $\rightarrow (.64 \text{ KLF/10})(30) = 1.92 \text{ KLF}$
 - pedestrian live loads $\rightarrow (.09 \text{ ksf})(10 \text{ ft}) = 0.90$
- LL = 2.82 KLF

- horizontal wind load

- design wind speed = 120 mph
 - $k_d = .85, k_{ze} = 1.0, G_F = .85, k_z = 1.03$
 - $q_z = .00256(k_z)(k_{ze})(k_d)(V)^2 = 32.27 \text{ psf}$
 - $p_w = q G_i C_p - q_i(GC_i) = 32.27(.85)(.8 + .18) = 27.75 \text{ psf}$
 - $p_r = " = 32.27(.85)(-.5) - .18 = 19.52 \text{ psf}$
- 47.27 psf

1/4" Grid

Calcs/Notes/Assignment #

Name: Zachary Gerst

Title: Willow Creek Bridge Design

Date: 3/22/17

- other reaction loads

- ↳ vehicle impact load (robot analysis) = 68.47 kip/lane
(HS20-14 truck on 80 ft bridge, force = reactions at supports(max))
- ↳ pile cap weight = (3 ft)(3 ft)(40 ft)(.15) = 59.4 kip (per abutment)
- ↳ retaining wall weight = (6 ft)(21 ft)(3 ft)(.15) = 56.7 kip (*2) (per abutment)

- total foundation load

- ↳ $w = DL(1.2) + LL(1.4) = 15.096 \text{ kLF}$
- ↳ loads at supports = $1.2(59.4 + 2(56.7)) + 1.6(2(68.47)) = 426.46 \text{ kip}$
- ↳ horizontal forces = $(.043)(6)(75)(1/2) = 9.675 \text{ kip}$

↳ reaction force (r_y) = $(2(426.46) + 80(15.096))(1/2)$
 $= \underline{\underline{1030.3 \text{ kip}}}$

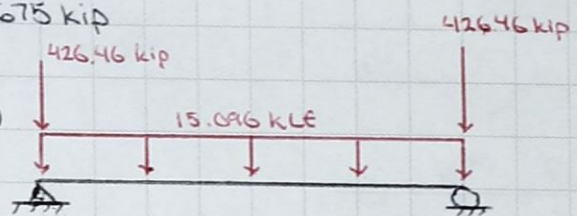

• pile design requirements

- Iowa DOT recommends HP 10x37 piles
- soil assumptions, water table = 0'-0
 $\gamma_{sat} = 120 \text{ pcf}$
 soil profile based on well data
 safety factor of 4

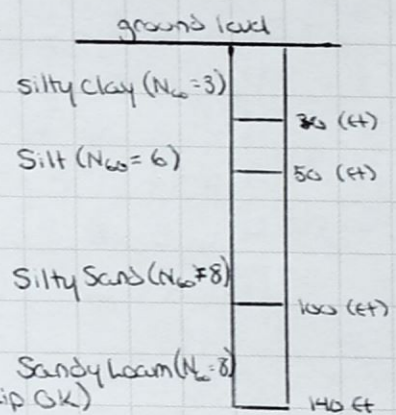

- pile layout

- ↳ 9 pile configuration (sp @ 5'-0 o.c.)
- ↳ load per pile = $(1030.3)(1.1)(1/9) = 125.9 \text{ kip} (< 243 \text{ kip OK})$
- ↳ lateral load per pile = $9.675 \text{ kip}/9 = 1.075 \text{ kip/pile} (< 6 \text{ kip OK})$

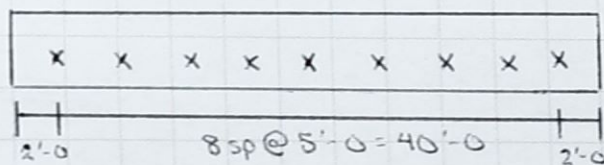

$d_1 = 9.99 \text{ in}^2$
 $d_2 = 10.225 \text{ in}$
 $A = 16.8 \text{ in}^2$
 $I = 294 \text{ in}^4$
 $D = 14.31 \text{ in}$
 $P = 40.43 \text{ in}$

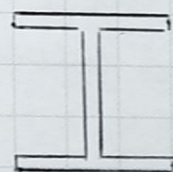

• soil layer calculations

- see attached MATHCAD WORK

	N_{60}	ϕ (deg)	σ_{top}	σ_{bottom}	
soil layer 1	3	28.94°	0 psc	4325 psc	
soil layer 2	6	28.94°	4325	6825	(soil layer 4 not needed)
soil layer 3	8	28.91°	6825	13075	



• pile length calculation

- design pile length = 70 ft

- pile point capacity (Meyerhoff's method)

$$\rightarrow Q_p = A_p q' N_q^* \quad (\text{Figure 9.13})$$

$$= (9.99 \cdot 10.225 / 144)(120 - 62.4)(70)(35) = 100.111 \text{ kip}$$

- pile side capacity (Meyerhoff's method)

$$\rightarrow Q_s = P_p (\sum s_{avg} h)$$

$$= (40.43/12) [30(1.65 \cdot 2.456 \cdot \tan(28.35^\circ/2)) + 20(1.65 \cdot 6.2 \cdot \tan(28.94^\circ/2)) + 20(1.65 \cdot 8.7 \cdot \tan(28.91^\circ/2))] = 530.689 \text{ kip}$$

- design capacity check

$$\rightarrow FS = (Q_p + Q_s) / P$$

$$= (100.111 + 530.689) / 125.900 = 5.010 \quad (\text{redesign})$$

- pile design length = 60 ft

- pile point capacity

$$\rightarrow Q_p = A_p q' N_q^*$$

$$= (9.99 \cdot 10.225 / 144)(120 - 62.4)(60)(35) = 85.8 \text{ kip}$$

- pile side capacity

$$\rightarrow Q_s = P_p (\sum s_{avg} h)$$

$$= (40.43/12) [30(1.65 \cdot 2.456 \cdot \tan(28.35^\circ/2)) + 20(1.65 \cdot 6.2 \cdot \tan(28.94^\circ/2)) + 10(1.65 \cdot 7.6 \cdot \tan(28.91^\circ/2))] = 390.252 \text{ kip}$$

- pile design capacity check

$$\rightarrow FS = (Q_p + Q_s) / P$$

$$= (85.8 + 390.3) / 125.9 = 3.78 \quad (w > 4 \text{ OK})$$

• pile settlement calculations

- elastic settlement (s_1) = $Q_p L / A_p E_s$

$$= \frac{22.7}{144} (60 \cdot 12) / (16.8 \cdot 29000) = .034 \text{ in}$$

- pile point settlement (s_2) = $Q_p D / E_s A_p (1 - \mu_s^2) (.85)$

$$= 22.7(14.31) / (160 \cdot 102.1)(1 - .35^2)(.85) = .021 \text{ in}$$

- pile side settlement (s_3) = $Q_s D / L P_p E_s (1 - \mu_s^2) (I_{ws})$

$$= 103.2(14.31) / (60 \cdot 12)(40.43)(120)(1 - .35^2)(4.26) = .002 \text{ in}$$

- total pile settlement = $s_1 + s_2 + s_3 = .057 \text{ in} \quad (\text{OK})$

1/4" Grid

Calcs/Notes/Assignment #

Name: Zachary Gerst

Title: Willow Creek Bridge Design

Date: 3/22/17

Bridge Cross-Section Design:

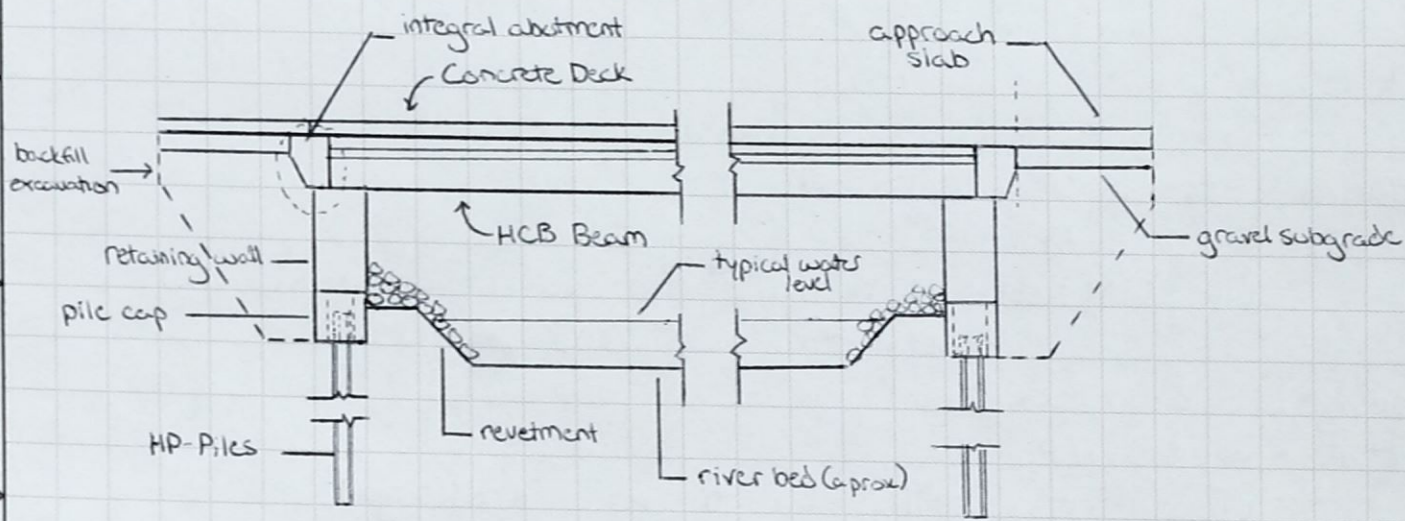

(Bridge Elevation View)

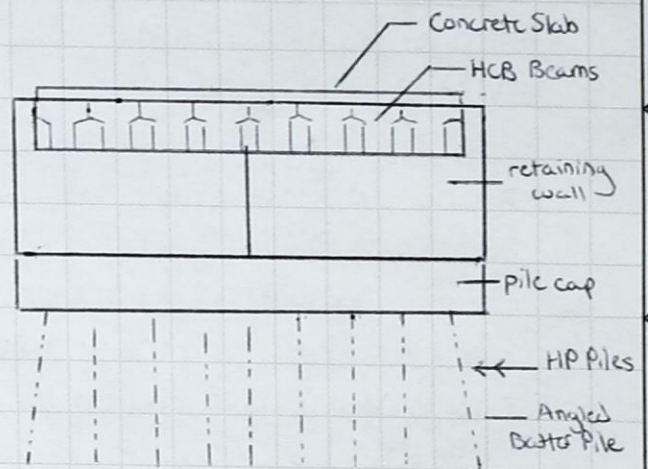
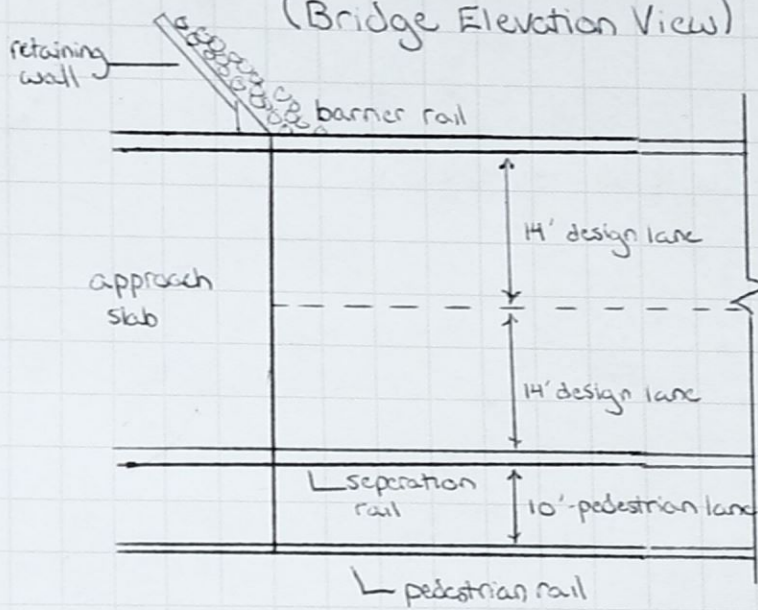

(Site Plan View)

- see autocad for full detailed drawings

Wingwall/Retaining Wall Design:

- cast in place
- separate from bridge abutment to speed up construction
- cantilever retaining wall design



Retaining Wall/Wingwall Design:

- soil elevation varies along length of wingwall
- design for approximate worst case loading near bridge abutment
- design calculations similar to concrete sheet pile
- use same soil data as pile foundation
- assume water level at ground level on downhill side
- granular backfill on uphill side of wall
- soil data;

- $\gamma_{backfill} = 125 \text{ pcf}$
- $\gamma_{in, \text{site}} (\text{set}) = 125 \text{ pcf}$
- $\phi = 28.94^\circ$, $c = 1279 \text{ psi}$
- insitu soil acts as clay
- $P = \text{wheel line load } (2\frac{2}{3} \text{ kip/ft})$
- $w = \text{roadway strip load } (144 \text{ psf})$

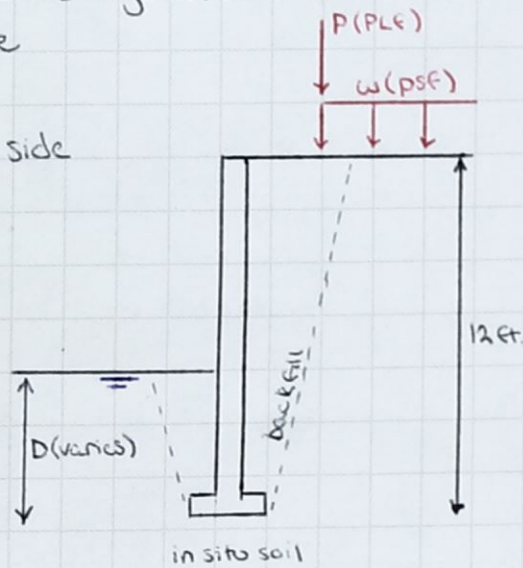

• Passive/Active Soil Constants

- Passive Soil Coefficient (K_p) = $\tan^2(45 + \frac{\phi}{2}) + 2c \tan(45 + \frac{\phi}{2})$
= 2.871
- Active Soil Coefficient (K_a) = $\tan^2(45 - \frac{\phi}{2})$
= .348

• Cantilever Pile Design

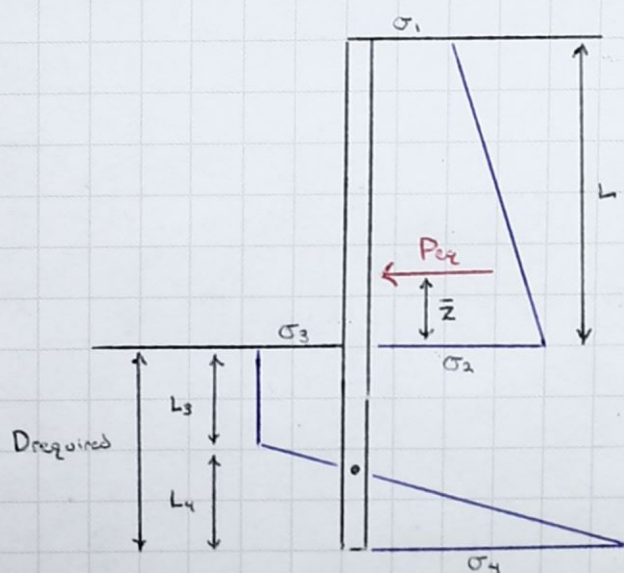

$L = 8 \text{ ft (varies)}$
 avg surcharge load (σ_1) = 216 psf (see surcharge excel file)
 $\sigma_2 = \sigma_1 + L \gamma_{backfill} = 1216 \text{ psf}$
 $\sigma_3 = 4c' - \gamma_{in, \text{site}} L = 4116 \text{ psf}$
 $\sigma_4 = 4c' + \gamma_{in, \text{site}} L = 6116 \text{ psf}$

$P_{02} = (L)(\sigma_2 + \sigma_1)/2 = 5728 \text{ pLF}$
 $\bar{z} = [(\sigma_1)(L^2/2) + (\sigma_2 - \sigma_1)(L^2/6)] = 3.07 \text{ ft}$

$c = 1279 \text{ psf}$

1/4" Grid

Calcs/Notes/Assignment #

Name: Zachary Gerst

Title: Willow Creek Bridge Design

Date: 3/29/17

$$0 = D^2(4c - \gamma_{\text{backfill}} L) - 2DR - \frac{(P)(P + 12cZ)}{\gamma_{\text{backfill}} L + 2c}$$

$$= 4116D^2 - 11456D - 85076.996$$

$$D_{\text{required}} = 6.145 \text{ ft}$$

- due to the quickly varying L and D values the required depth of embedment is satisfactory for the majority of the wingwall. Either a steel tieback or connection/support from the retaining wall abutment is recommended near the end of the wingwall closest to the river.

$$\text{Maximum Moment of wingwall (M}_{\text{max}}) = P_{\text{eq}} \left(\frac{P_{\text{eq}}}{\sigma_3} + \bar{z} \right) - \sigma_3 \left(\frac{P_{\text{eq}}}{\sigma_3} \right)^2 \left(\frac{1}{2} \right)$$

$$M_{\text{max}} = 21513 \text{ lb} \cdot \text{ft}$$

• Bearing Capacity of Wall Foundation

$$- q_{\text{applied}} = 1012.5 \text{ psf} = (10.5)(1)(150) + (1.5)(2)(150)$$

$$- q_{\text{allow}} = c' N_c F_{cs} F_{cd} F_{ci} + q N_q F_{qs} F_{qd} F_{qi} + \frac{1}{2} B \gamma N_s F_{ss} F_{sd} F_{si}$$

$$\rightarrow c = 1279 \text{ psf}$$

$$\rightarrow q = 500$$

$$\rightarrow B = 8 \text{ ft}$$

$$\rightarrow N_c = 27.86$$

$$\rightarrow F_{qs} = 1 + \frac{B}{L} \tan \phi = 1.13$$

$$\rightarrow \gamma = 125 \text{ psf}$$

$$\rightarrow F_{cs} = 1 + \frac{B}{L} \left(\frac{N_q}{N_c} \right) = 1.147$$

$$\rightarrow F_{qd} = 1.147$$

$$\rightarrow F_{ss} = 1 - 0.4 \left(\frac{B}{L} \right) = 0.9$$

$$\rightarrow F_{cd} = F_{qd} - \frac{1 - F_{qd}}{N_c \tan \phi} = 1.16$$

$$\rightarrow F_{qi} = 1$$

$$\rightarrow F_{sq} = 1$$

$$\rightarrow F_{ci} = 1$$

$$\rightarrow N_q = 16.44$$

$$\rightarrow F_{si} = 1$$

$$\rightarrow q_{\text{allow}} = 66767 \text{ psf} \text{ (design is OK (} q_{\text{applied}} < q_{\text{allow}} \text{))}$$

SOIL PROPERTY CALCULATIONS:

$$\begin{array}{lll}
 N_{10} := 3 & d := 10 & \alpha := 10 \text{ Assumed Value} \\
 \eta_H := 60 & d_{GW} := 10 & \\
 \eta_S := 1.00 & \gamma := 120 & \\
 \eta_B := 1.00 & \gamma_{sat} := 125 & \\
 \eta_R := 0.85 & p_a := 2000 \text{ psf} &
 \end{array}$$

$$N_{60} := \frac{N_{10} \cdot \eta_H \cdot \eta_S \cdot \eta_B \cdot \eta_R}{60} = 2.55 \quad N_{60} := 3.00 \quad \text{Rounded} \quad (\text{Eq. 3.6})$$

$$\sigma_o := \gamma \cdot d = 1.2 \cdot 10^3 \text{ psf}$$

$$C_N := \left(\frac{p_a}{\sigma_o} \right)^{.5} = 1.291 \quad (\text{Eq. 3.13})$$

$$N_{1.60} := (N_{60}) \cdot C_N = 3.873 \quad (\text{Eq. 3.12})$$

$$N_{1.60} := 4.00 \quad \text{Round Up}$$

$$\phi_{10} := \sqrt{20 \cdot N_{1.60}} + 20 = 28.944 \text{ degree} \quad (\text{Eq. 3.31})$$

$$E_{s10} := \alpha \cdot p_a \cdot N_{60} = 6 \cdot 10^4 \text{ psi} \quad (\text{Eq. 3.32})$$

$$c_{u10} := .29 \cdot N_{60}^{.72} \cdot p_a = 1.279 \cdot 10^3 \text{ psi} \quad (\text{Eq. 3.8})$$

$$\begin{array}{lll}
 N_{20} := 3 & d := 20 & \alpha := 10 \text{ Assumed Value} \\
 \eta_H := 60 & d_{GW} := 10 & \\
 \eta_S := 1.00 & \gamma := 120 & \\
 \eta_B := 1.00 & \gamma_{sat} := 125 & \\
 \eta_R := 0.95 & p_a := 2000 \text{ psf} &
 \end{array}$$

$$N_{60} := \frac{N_{20} \cdot \eta_H \cdot \eta_S \cdot \eta_B \cdot \eta_R}{60} = 2.85 \quad N_{60} := 3.00 \quad \text{Rounded} \quad (\text{Eq. 3.6})$$

$$\sigma_o := \gamma \cdot d = 2.4 \cdot 10^3 \text{ psf}$$

$$C_N := \left(\frac{p_a}{\sigma_o} \right)^{.5} = 0.913 \quad (\text{Eq. 3.13})$$

$$N_{1.60} := (N_{60}) \cdot C_N = 2.739 \quad (\text{Eq. 3.12})$$

$$N_{1.60} := 3.00 \quad \text{Round Up}$$

$$\phi_{20} := \sqrt{20 \cdot N_{1.60}} + 20 = 27.746 \text{ degree} \quad (\text{Eq. 3.31})$$

$$E_{s20} := \alpha \cdot p_a \cdot N_{60} = 6 \cdot 10^4 \text{ psi} \quad (\text{Eq. 3.32})$$

$$c_{u20} := .29 \cdot N_{60}^{.72} \cdot p_a = 1.279 \cdot 10^3 \text{ psi} \quad (\text{Eq. 3.8})$$

$$\begin{array}{lll}
 N_{30} := 3 & d := 30 & \alpha := 10 \text{ Assumed Value} \\
 \eta_H := 60 & d_{GW} := 10 & \\
 \eta_S := 1.00 & \gamma := 120 & \\
 \eta_B := 1.00 & \gamma_{sat} := 125 & \\
 \eta_R := 0.85 & p_a := 2000 \text{ psf} &
 \end{array}$$

$$N_{60} := \frac{N_{30} \cdot \eta_H \cdot \eta_S \cdot \eta_B \cdot \eta_R}{60} = 2.55 \quad N_{60} := 3.00 \quad \text{Rounded} \quad (\text{Eq. 3.6})$$

$$\sigma_o := \gamma \cdot d = 3.6 \cdot 10^3 \text{ psf}$$

$$C_N := \left(\frac{p_a}{\sigma_o} \right)^{.5} = 0.745 \quad (\text{Eq. 3.13})$$

$$N_{1.60} := (N_{60}) \cdot C_N = 2.236 \quad (\text{Eq. 3.12})$$

$$N_{1.60} := 3.00 \quad \text{Round Up}$$

$$\phi_{30} := \sqrt{20 \cdot N_{1.60}} + 20 = 27.746 \text{ degree} \quad (\text{Eq. 3.31})$$

$$E_{s30} := \alpha \cdot p_a \cdot N_{60} = 6 \cdot 10^4 \text{ psi} \quad (\text{Eq. 3.32})$$

$$c_{u30} := .29 \cdot N_{60}^{.72} \cdot p_a = 1.279 \cdot 10^3 \text{ psi} \quad (\text{Eq. 3.8})$$

$$\begin{array}{lll}
 N_{40} := 6 & d := 40 & \alpha := 10 \text{ Assumed Value} \\
 \eta_H := 60 & d_{GW} := 10 & \\
 \eta_S := 1.00 & \gamma := 120 & \\
 \eta_B := 1.00 & \gamma_{sat} := 125 & \\
 \eta_R := 0.95 & p_a := 2000 \text{ psf} &
 \end{array}$$

$$N_{60} := \frac{N_{40} \cdot \eta_H \cdot \eta_S \cdot \eta_B \cdot \eta_R}{60} = 5.7 \quad N_{60} := 6.00 \quad \text{Rounded} \quad (\text{Eq. 3.6})$$

$$\sigma_o := \gamma \cdot d = 4.8 \cdot 10^3 \text{ psf}$$

$$C_N := \left(\frac{p_a}{\sigma_o} \right)^{.5} = 0.645 \quad (\text{Eq. 3.13})$$

$$N_{1.60} := (N_{60}) \cdot C_N = 3.873 \quad (\text{Eq. 3.12})$$

$$N_{1.60} := 4.00 \quad \text{Round Up}$$

$$\phi_{40} := \sqrt{20 \cdot N_{1.60}} + 20 = 28.944 \text{ degree} \quad (\text{Eq. 3.31})$$

$$E_{s40} := \alpha \cdot p_a \cdot N_{60} = 1.2 \cdot 10^5 \text{ psi} \quad (\text{Eq. 3.32})$$

$$c_{u40} := .29 \cdot N_{60}^{.72} \cdot p_a = 2.107 \cdot 10^3 \text{ psi} \quad (\text{Eq. 3.8})$$

$$\begin{array}{lll}
 N_{50} := 6 & d := 50 & \alpha := 10 \text{ Assumed Value} \\
 \eta_H := 60 & d_{GW} := 10 & \\
 \eta_S := 1.00 & \gamma := 120 & \\
 \eta_B := 1.00 & \gamma_{sat} := 125 & \\
 \eta_R := 1.00 & p_a := 2000 \text{ psf} &
 \end{array}$$

$$N_{60} := \frac{N_{50} \cdot \eta_H \cdot \eta_S \cdot \eta_B \cdot \eta_R}{60} = 6 \quad N_{60} := 6 \quad \text{Rounded} \quad (\text{Eq. 3.6})$$

$$\sigma_o := \gamma \cdot d = 6 \cdot 10^3 \text{ psf}$$

$$C_N := \left(\frac{p_a}{\sigma_o} \right)^{.5} = 0.577 \quad (\text{Eq. 3.13})$$

$$\begin{array}{l}
 N_{1.60} := (N_{60}) \cdot C_N = 3.464 \\
 N_{1.60} := 4.00 \quad \text{Round Up}
 \end{array} \quad (\text{Eq. 3.12})$$

$$\phi_{50} := \sqrt{20 \cdot N_{1.60}} + 20 = 28.944 \text{ degree} \quad (\text{Eq. 3.31})$$

$$E_{s50} := \alpha \cdot p_a \cdot N_{60} = 1.2 \cdot 10^5 \text{ psi} \quad (\text{Eq. 3.32})$$

$$c_{u50} := .29 \cdot N_{60}^{.72} \cdot p_a = 2.107 \cdot 10^3 \text{ psi} \quad (\text{Eq. 3.8})$$

$$\begin{array}{lll}
 N_{60} := 8 & d := 60 & \alpha := 10 \text{ Assumed Value} \\
 \eta_H := 60 & d_{GW} := 10 & \\
 \eta_S := 1.00 & \gamma := 120 & \\
 \eta_B := 1.00 & \gamma_{sat} := 125 & \\
 \eta_R := 1.00 & p_a := 2000 \text{ psf} &
 \end{array}$$

$$N_{60} := \frac{N_{60} \cdot \eta_H \cdot \eta_S \cdot \eta_B \cdot \eta_R}{60} = 8 \quad N_{60} := 8.00 \quad \text{Rounded} \quad (\text{Eq. 3.6})$$

$$\sigma_o := \gamma \cdot d = 7.2 \cdot 10^3 \text{ psf}$$

$$C_N := \left(\frac{p_a}{\sigma_o} \right)^{.5} = 0.527 \quad (\text{Eq. 3.13})$$

$$\begin{array}{l}
 N_{1.60} := (N_{60}) \cdot C_N = 4.216 \\
 N_{1.60} := 5.00 \quad \text{Round Up}
 \end{array} \quad (\text{Eq. 3.12})$$

$$\phi_{60} := \sqrt{20 \cdot N_{1.60}} + 20 = 30 \text{ degree} \quad (\text{Eq. 3.31})$$

$$E_{s60} := \alpha \cdot p_a \cdot N_{60} = 1.6 \cdot 10^5 \text{ psi} \quad (\text{Eq. 3.32})$$

$$c_{u60} := .29 \cdot N_{60}^{.72} \cdot p_a = 2.592 \cdot 10^3 \text{ psi} \quad (\text{Eq. 3.8})$$

$$\begin{array}{lll}
 N_{70} := 8 & d := 70 & \alpha := 10 \quad \text{Assumed Value} \\
 \eta_H := 60 & d_{GW} := 10 & \\
 \eta_S := 1.00 & \gamma := 120 & \\
 \eta_B := 1.00 & \gamma_{sat} := 125 & \\
 \eta_R := 1.00 & p_a := 2000 \text{ psf} &
 \end{array}$$

$$N_{60} := \frac{N_{70} \cdot \eta_H \cdot \eta_S \cdot \eta_B \cdot \eta_R}{60} = 8 \quad N_{60} := 8.00 \quad \text{Rounded} \quad (\text{Eq. 3.6})$$

$$\sigma_o := \gamma \cdot d = 8.4 \cdot 10^3 \text{ psf}$$

$$C_N := \left(\frac{p_a}{\sigma_o} \right)^{.5} = 0.488 \quad (\text{Eq. 3.13})$$

$$N_{1.60} := (N_{60}) \cdot C_N = 3.904 \quad (\text{Eq. 3.12})$$

$$N_{1.60} := 4.00 \quad \text{Round Up}$$

$$\phi_{60} := \sqrt{20 \cdot N_{1.60}} + 20 = 28.944 \text{ degree} \quad (\text{Eq. 3.31})$$

$$E_{s60} := \alpha \cdot p_a \cdot N_{60} = 1.6 \cdot 10^5 \text{ psi} \quad (\text{Eq. 3.32})$$

$$c_{u60} := .29 \cdot N_{60}^{.72} \cdot p_a = 2.592 \cdot 10^3 \text{ psi} \quad (\text{Eq. 3.8})$$

$$\begin{array}{lll}
 N_{80} := 8 & d := 80 & \alpha := 10 \quad \text{Assumed Value} \\
 \eta_H := 60 & d_{GW} := 10 & \\
 \eta_S := 1.00 & \gamma := 120 & \\
 \eta_B := 1.00 & \gamma_{sat} := 125 & \\
 \eta_R := 1.00 & p_a := 2000 \text{ psf} &
 \end{array}$$

$$N_{60} := \frac{N_{80} \cdot \eta_H \cdot \eta_S \cdot \eta_B \cdot \eta_R}{60} = 8 \quad N_{60} := 8.00 \quad \text{Rounded} \quad (\text{Eq. 3.6})$$

$$\sigma_o := \gamma \cdot d = 9.6 \cdot 10^3 \text{ psf}$$

$$C_N := \left(\frac{p_a}{\sigma_o} \right)^{.5} = 0.456 \quad (\text{Eq. 3.13})$$

$$N_{1.60} := (N_{60}) \cdot C_N = 3.651 \quad (\text{Eq. 3.12})$$

$$N_{1.60} := 4.00 \quad \text{Round Up}$$

$$\phi_{60} := \sqrt{20 \cdot N_{1.60}} + 20 = 28.944 \text{ degree} \quad (\text{Eq. 3.31})$$

$$E_{s60} := \alpha \cdot p_a \cdot N_{60} = 1.6 \cdot 10^5 \text{ psi} \quad (\text{Eq. 3.32})$$

$$c_{u60} := .29 \cdot N_{60}^{.72} \cdot p_a = 2.592 \cdot 10^3 \text{ psi} \quad (\text{Eq. 3.8})$$

$$\begin{array}{lll}
 N_{90} := 8 & d := 90 & \alpha := 10 \text{ Assumed Value} \\
 \eta_H := 60 & d_{GW} := 10 & \\
 \eta_S := 1.00 & \gamma := 120 & \\
 \eta_B := 1.00 & \gamma_{sat} := 125 & \\
 \eta_R := 1.00 & p_a := 2000 \text{ psf} &
 \end{array}$$

$$N_{60} := \frac{N_{90} \cdot \eta_H \cdot \eta_S \cdot \eta_B \cdot \eta_R}{60} = 8 \quad N_{60} := 8.00 \text{ Rounded} \quad (\text{Eq. 3.6})$$

$$\sigma_o := \gamma \cdot d = 1.08 \cdot 10^4 \text{ psf}$$

$$C_N := \left(\frac{p_a}{\sigma_o} \right)^{.5} = 0.43 \quad (\text{Eq. 3.13})$$

$$N_{1.60} := (N_{60}) \cdot C_N = 3.443 \quad (\text{Eq. 3.12})$$

$$N_{1.60} := 4.00 \text{ Round Up}$$

$$\phi_{60} := \sqrt{20 \cdot N_{1.60}} + 20 = 28.944 \text{ degree} \quad (\text{Eq. 3.31})$$

$$E_{s60} := \alpha \cdot p_a \cdot N_{60} = 1.6 \cdot 10^5 \text{ psi} \quad (\text{Eq. 3.32})$$

$$c_{u60} := .29 \cdot N_{60}^{.72} \cdot p_a = 2.592 \cdot 10^3 \text{ psi} \quad (\text{Eq. 3.8})$$

$$\begin{array}{lll}
 N_{100} := 8 & d := 100 & \alpha := 10 \text{ Assumed Value} \\
 \eta_H := 60 & d_{GW} := 10 & \\
 \eta_S := 1.00 & \gamma := 120 & \\
 \eta_B := 1.00 & \gamma_{sat} := 125 & \\
 \eta_R := 1.00 & p_a := 2000 \text{ psf} &
 \end{array}$$

$$N_{60} := \frac{N_{100} \cdot \eta_H \cdot \eta_S \cdot \eta_B \cdot \eta_R}{60} = 8 \quad N_{60} := 8.00 \text{ Rounded} \quad (\text{Eq. 3.6})$$

$$\sigma_o := \gamma \cdot d = 1.2 \cdot 10^4 \text{ psf}$$

$$C_N := \left(\frac{p_a}{\sigma_o} \right)^{.5} = 0.408 \quad (\text{Eq. 3.13})$$

$$N_{1.60} := (N_{60}) \cdot C_N = 3.266 \quad (\text{Eq. 3.12})$$

$$N_{1.60} := 3.00 \text{ Round}$$

$$\phi_{60} := \sqrt{20 \cdot N_{1.60}} + 20 = 27.746 \text{ degree} \quad (\text{Eq. 3.31})$$

$$E_{s60} := \alpha \cdot p_a \cdot N_{60} = 1.6 \cdot 10^5 \text{ psi} \quad (\text{Eq. 3.32})$$

$$c_{u60} := .29 \cdot N_{60}^{.72} \cdot p_a = 2.592 \cdot 10^3 \text{ psi} \quad (\text{Eq. 3.8})$$

PILE SIDE FRICTION CALCULATIONS WORKSHEET

Project: Willow Creek Bridge Foundation Design

By: Zach Gerst

Date: 3/29/17

INPUT DATA									
Layer Data								Pile Geometry	
Sample Layer	ΔL (ft.)	N Value	η_r	ϕ' (deg)	E_s (psi)	c' (psi)		Pile Type	HP 10x42
0	0.00	3.00	0.85	28.94	60000	1279		d_1 (in.)	9.990
1	10.00	3.00	0.85	28.94	60000	1279			
2	20.00	3.00	0.95	27.75	60000	1279		d_2 (in.)	10.225
3	30.00	3.00	0.95	27.75	60000	1279		w (in.)	0.420
4	40.00	6.00	1.00	28.94	120000	2107		A_p (in.^2)	12.400
5	50.00	6.00	1.00	28.94	120000	2107			
6	60.00	8.00	1.00	30.00	160000	2592			
7	70.00	8.00	1.00	28.94	160000	2592			
8	80.00	8.00	1.00	28.94	160000	2592			
9	90.00	8.00	1.00	28.94	160000	2592			
10	100.00	8.00	1.00	27.75	160000	2592		P_p (in.)	40.430

SOIL OUTPUT DATA									
Sample Layer	D_{top} (ft.)	D_{bottom} (ft.)	ΔL (ft.)	N Value	η_r	σ'_{avg} (psf)	ϕ'	E_s (psi)	c' (psi)
0	0.00	10.00	10.00	3	0.85	600	28.94	60000	0
1	10.00	20.00	10.00	3	0.85	1825	28.94	60000	0
2	20.00	30.00	10.00	3	0.95	3075	27.75	60000	0
3	30.00	40.00	10.00	3	0.95	4325	27.75	60000	0
4	40.00	50.00	10.00	6	1.00	5575	28.94	120000	0
5	50.00	60.00	10.00	6	1.00	6825	28.94	120000	0
6	60.00	70.00	10.00	8	1.00	8075	30.00	160000	0
7	70.00	80.00	10.00	8	1.00	9325	28.94	160000	0
8	80.00	90.00	10.00	8	1.00	10575	28.94	160000	0
9	90.00	100.00	10.00	8	1.00	11825	28.94	160000	0
10	100.00	110.00	10.00	8	1.00	13075	27.75	160000	0

PILE SIDE FRICTION OUTPUT DATA					
Soil Layer	σ'_{avg} (psf)	K	f_i	f_{ave} (psf)	P_s (kip)
1	2456.25	1.65	1733.288	1733.288	175.1921
2	6200	1.65	4375.118	4375.118	294.8101
3	10575	1.65	7462.4	7462.4	1257.103
4		1.65	0		
Total P_s					1727.106
Total P_p					0

*All Data Taken From Attached Mathcad Files

SURCHARGE LOAD CALCULATIONS WORKSHEET

Project: _____

By: _____

Date: _____

Lat. Pressure (Line Load)		
	z (ft.)	σ (psf)
1	0	0.00
2	1	134.88
3	2	213.23
4	3	227.81
5	4	204.58
6	5	168.89
7	6	134.18
8	7	105.14
9	8	82.32
10	9	64.81
11	10	51.49
12	11	41.33
13	12	33.52

Lat. Pressure (Strip Load)				
	z (ft.)	α (deg)	β (deg)	σ (psf)
1	0	90	0	0
2	1	87.4	7.95	25.34529
3	2	84.81	15.42	48.642
4	3	82.23	22.05	68.42484
5	4	79.7	27.68	84.13075
6	5	77.2	32.31	95.85866
7	6	74.74	36.03	104.067
8	7	72.35	38.96	109.341
9	8	70.02	41.24	112.261
10	9	67.75	42.99	113.3206
11	10	65.56	44.29	112.9109
12	11	63.43	45.25	111.3998
13	12	61.39	45.91	109.0488

Load Data (Line Load):	
q (plf)	2666.6667
H (ft.)	12
a (ft/ft)	0.5

Load Data (Strip Load):	
q (psf)	144
H (ft.)	12
b' (ft)	6
a' (ft)	32

Combined Earth Pressures		
	z (ft.)	σ (psf)
1	0	0.00
2	1	160.23
3	2	261.87
4	3	296.23
5	4	288.71
6	5	264.74
7	6	238.25
8	7	214.48
9	8	194.58
10	9	178.13
11	10	164.40
12	11	152.73
13	12	142.57

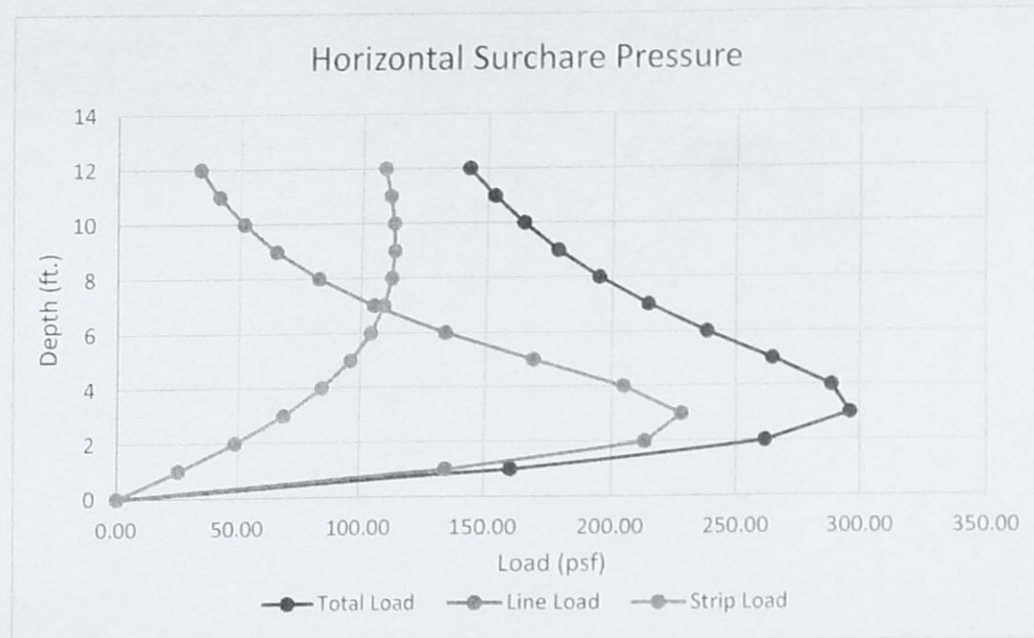

Average Surchare (ksf)	215.8607
-------------------------------	-----------------

10.6. Supplemental Information

Well Boring Data.....116
Hybrid Composite Beam Sizing Sheet.....117

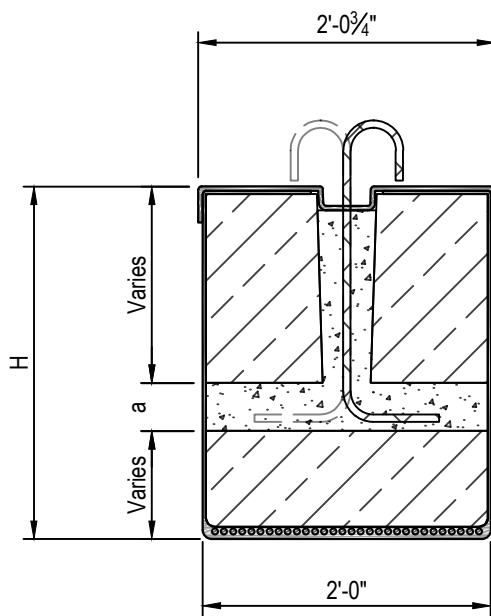

Standard Section

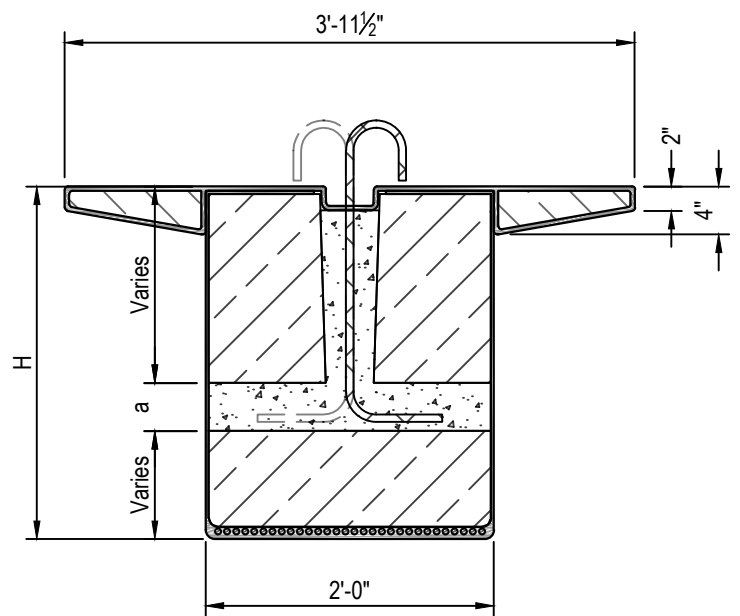

With Integral Deck Form
(Top Flange)

HCB Typical Section

Preliminary HCB Section Info Highway Bridges

Beam Depth	Arch Ht (a)	Approximate Max Span	Weightt (Lbs/Ft)	
			Empty	Filled
18 In	4 In	36 Ft	56	183
21 In	4 In	43 Ft	56	187
24 In	4 In	50 Ft	58	194
27 In	4 In	55 Ft	59	201
30 In	5 In	62 Ft	61	228
33 In	5 In	69 Ft	63	234
36 In	5 In	75 Ft	65	241
39 In	6 In	81 Ft	67	248
42 In	6 In	85 Ft	68	254

Notes:

1. Preliminary section properties based simple span with HL-93 Live Load in accordance with AASHTO LRFD Code Provisions
2. Preliminary section properties assume an 8" minimum concrete deck made composite cast in the field.
3. Assumed material properties
 - 3.1. Concrete Arch: 6,000 PSI @ 28 days
 - 3.2. Strands: ASTM A416, 270 KSI, Galvanized
 - 3.3. Shear Connectors: ASTM A615 Gr 60, Galvanized

FOR INFORMATION ONLY

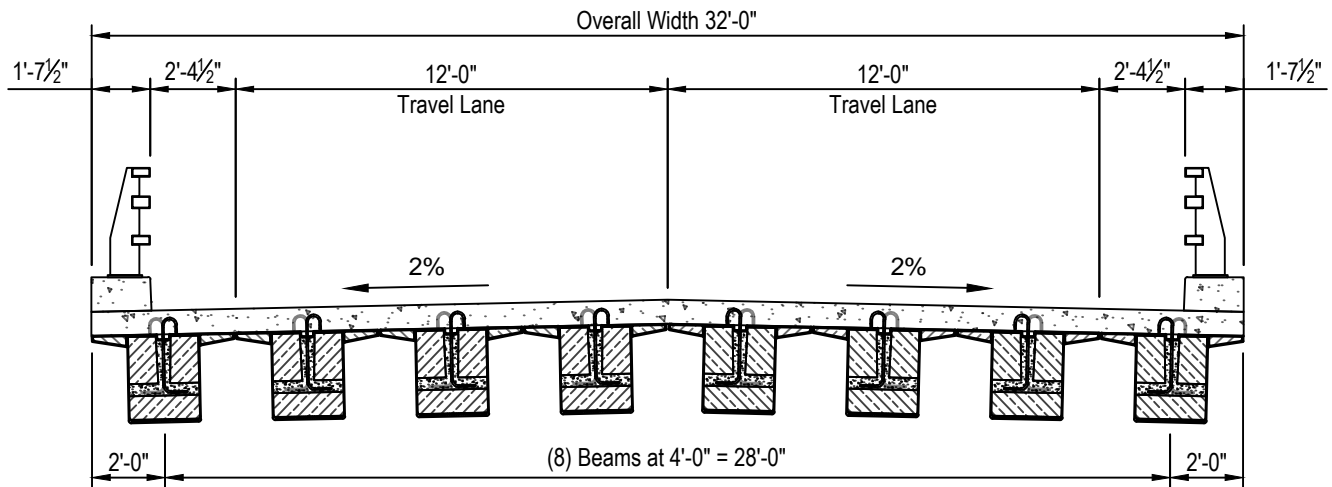

HCB Highway Bridge Typical Section

Using HCBs with Integral Deck Form

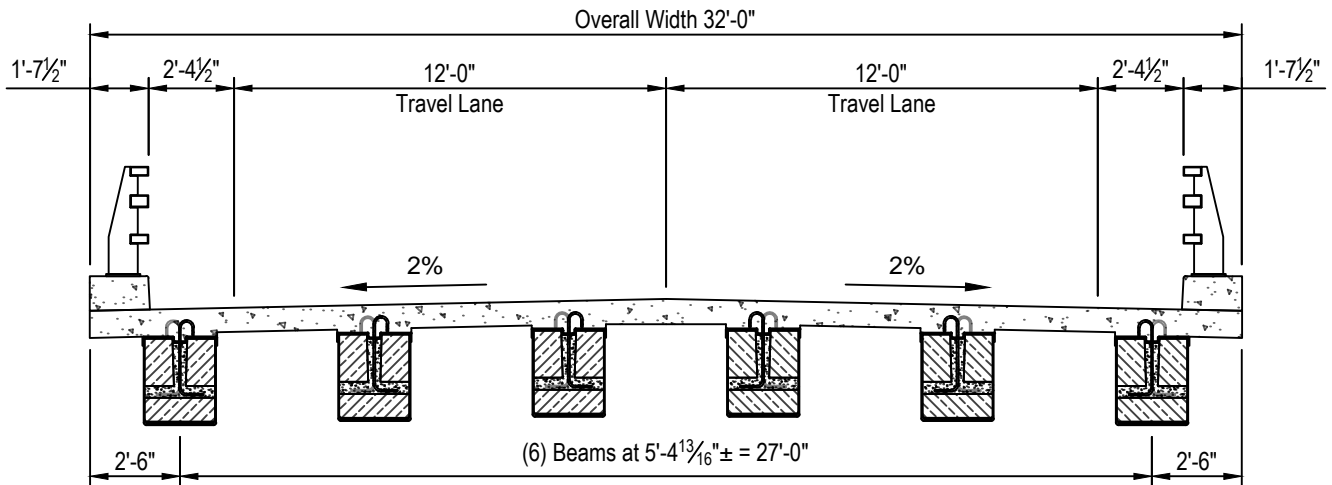

HCB Highway Bridge Typical Section

Using HCBs with SIP or Removable Deck Forms

Notes:

- Sections shown are typical. Beam size and spacing to be based on final design and geometry of bridge

FOR INFORMATION ONLY

IOWA GEOLOGICAL SURVEY
In Cooperation with U. S. Geological Survey
RECORD OF WELL

W12133

Location: NW CORNER OF CITY

Town: Mason City (NE)
(SW) County Cerro Gordo

SW 1/4 SE 1/4 sec. 5 T. 96 N., R. 20 (W) Twp.

Well name and number _____

Owner Indian Head Farms #2 Address Mason City Iowa

Tenant Mac Nieder? Address _____

Contractor Art & Dale Butts Address Clear Lake Iowa

Drillers Art Butts

Drilling dates June 2 - 13, 1960

Well data:

Altitudes: Drilling curb _____ feet; Land surface _____ feet

Determined by _____

Topographic position Upland

Total depth: Reported 265 feet; Measured _____ feet

Drilling method Cable

Hole and casing data 85' of 6 1/4" hole, 45' of 6 1/4" csg.
180' of 5 3/16" hole

Original depth to water _____ above
ft. below _____ Date _____

Source of data _____

Sources of water: Principal 250-265

Others _____

PRODUCTION DATA

Date _____

Static water level 23

Pumping water level 32

Yield (g.p.m.) 30 g/m

Measuring point _____

Duration of pumping _____

Specific capacity _____

LABORATORY DATA

Well No. W12133 Sample range 0-265 No. of samples 53

No. of dupls. and cond. 52 G Washed range 35-265

Samples prepared by Campbell Date 7/7/60

Logged by Koch Date Jan 10, 1961

Correlations by Koch Date Jan 10, 1961

10.7. Notes