

# City of Preston

## Preston Connectivity Plan and Design



SHEET NO.	INDEX OF SHEETS
1	TITLE SHEET
2-4	BECHAWA SIDE PATH
5-7	HIGHWAY 64 SIDE PATH
8-9	STREET CROSSINGS
10-18	SCHOOL ST ALTERNATIVES
19-21	NEIGHBORHOOD DEVELOPMENT
22-29	COPPER CREEK ALTERNATIVES

PROJECT:	CEE: 4850
DATE :	5-05-2022
DRAWN BY:	EF
REVISION:	

**THE UNIVERSITY OF IOWA**  
**CIVIL AND ENVIRONMENTAL ENGINEERING**  
 4105 SEAMANS CENTER FOR THE  
 ENGINEERING ARTS AND SCIENCES  
 103 S CAPITOL ST  
 IOWA CITY, IOWA 52242  
 PHONE: 319.335.5647  
 FAX: 319.335.5660  
 EMAIL: [civil-hawks@iowa.edu](mailto:civil-hawks@iowa.edu)



EDUCATIONAL - NOT  
FOR CONSTRUCTION

**Preston Connectivity**  
 City Of Preston

SHEET NAME  
 Title Sheet

SHEET NO.  
**1**

# Detail A Curb Ramp One-Way

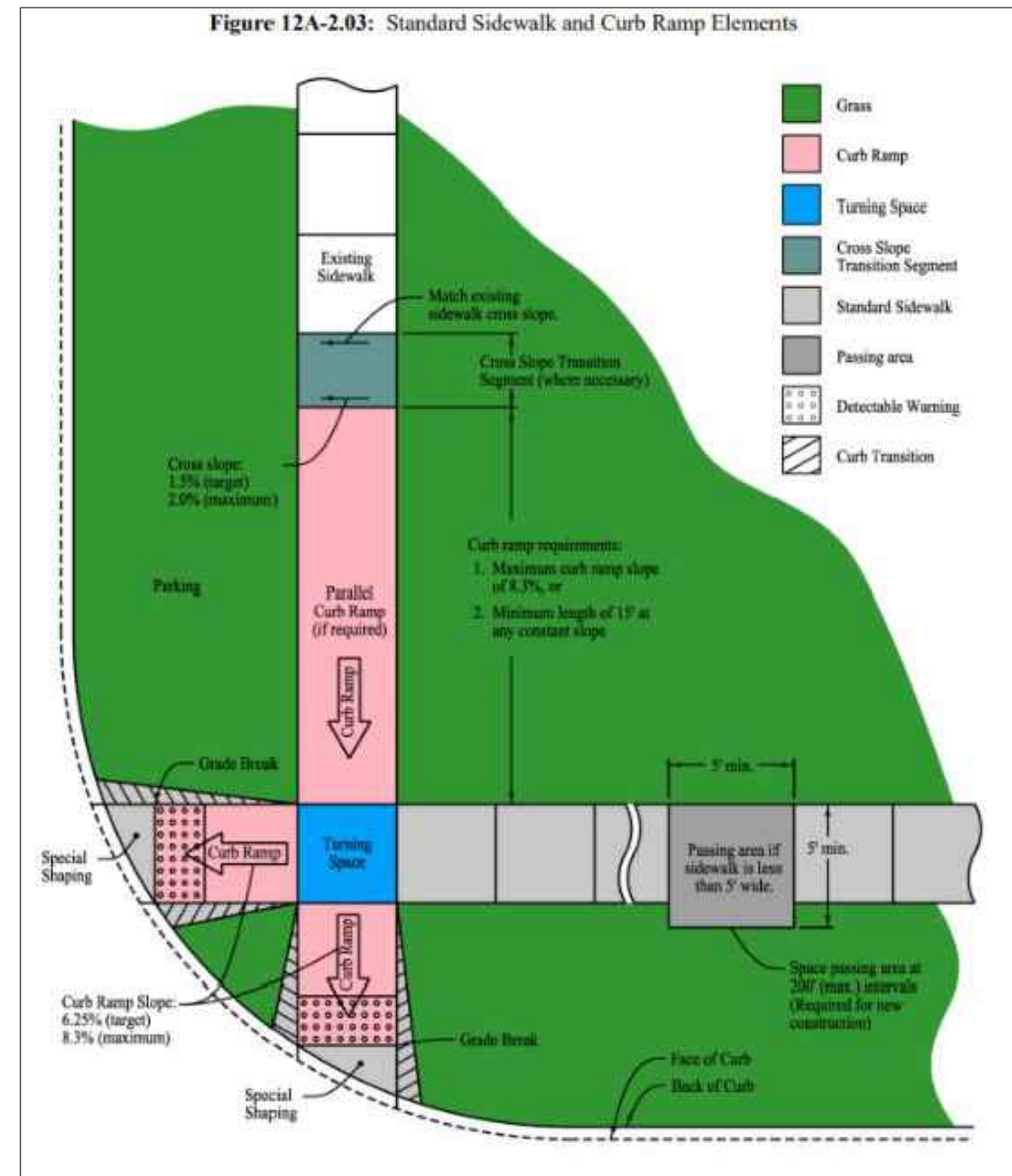

# Detail B Curb Ramp Two-Way

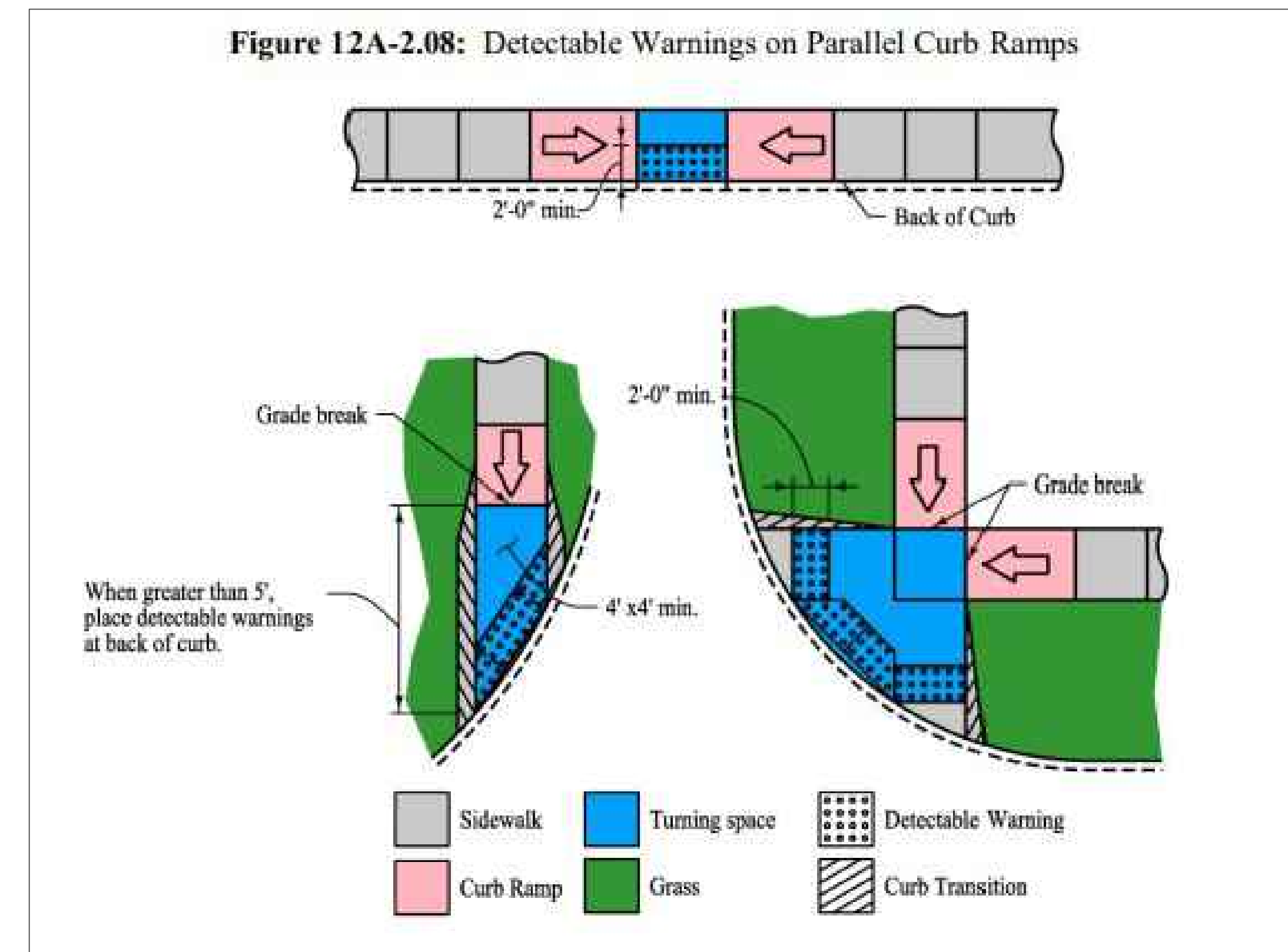

# Detail C Retaining Wall

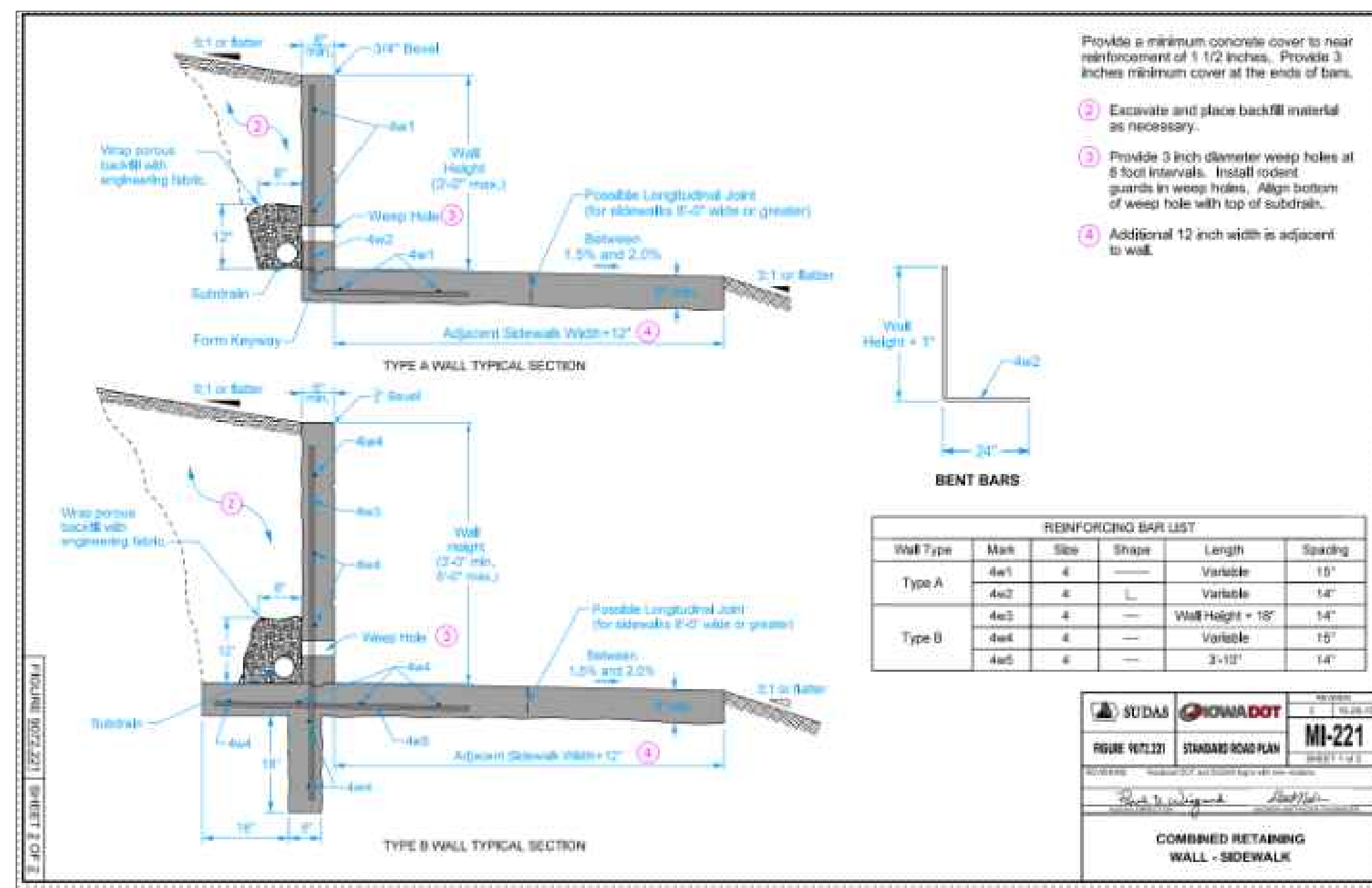

# Detail D Guard Rail

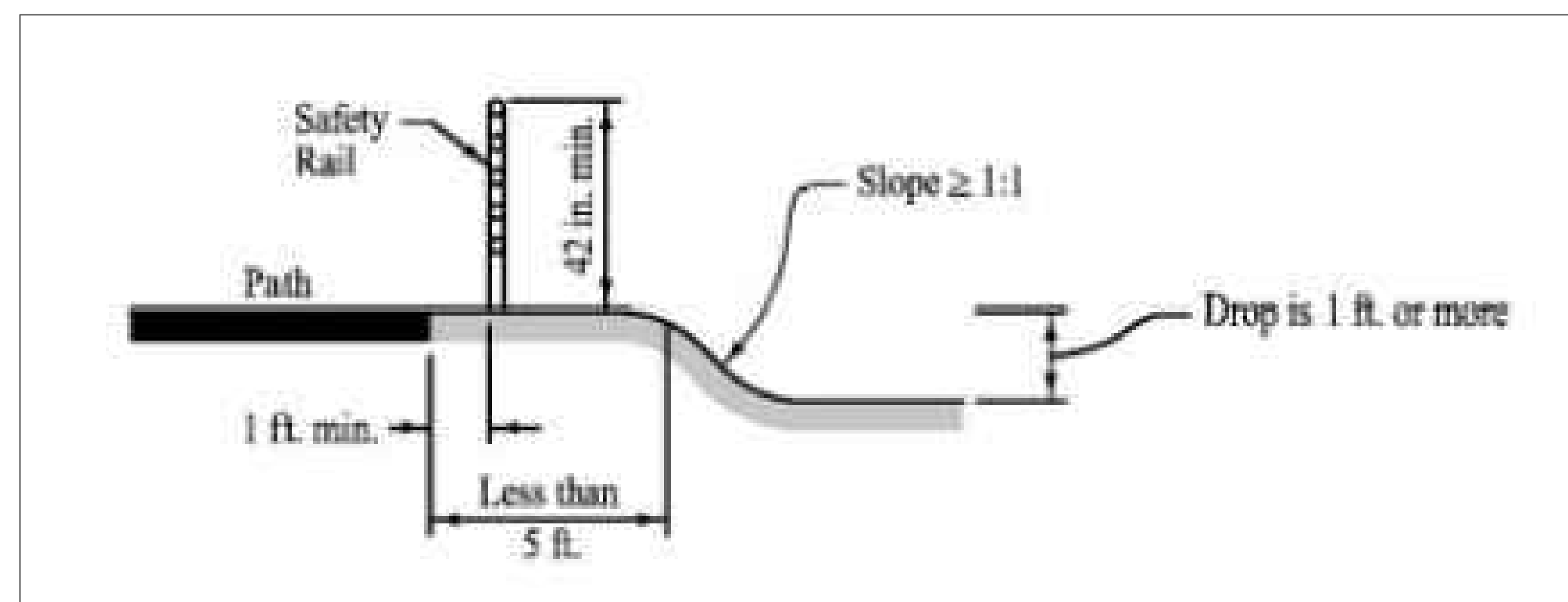

PROJECT: CEE: 4850  
DATE: 5-05-2022  
DRAWN BY: EF  
REVISION:

THE UNIVERSITY OF IOWA  
CIVIL AND ENVIRONMENTAL ENGINEERING  
4105 SEAMANS CENTER FOR THE  
ENGINEERING ARTS AND SCIENCES  
103 S. CAPITOL ST  
IOWA CITY, IOWA 52242  
PHONE: 319.335.5647  
FAX: 319.335.5660  
EMAIL: civil-hawks@iowa.edu



EDUCATIONAL - NOT FOR CONSTRUCTION

**Preston Connectivity**  
City Of Preston  
PROJECT ADDRESS 2

SHEET NAME  
DETAIL

SHEET NO.  
**2**

Detail E

5' Trail Cross Section

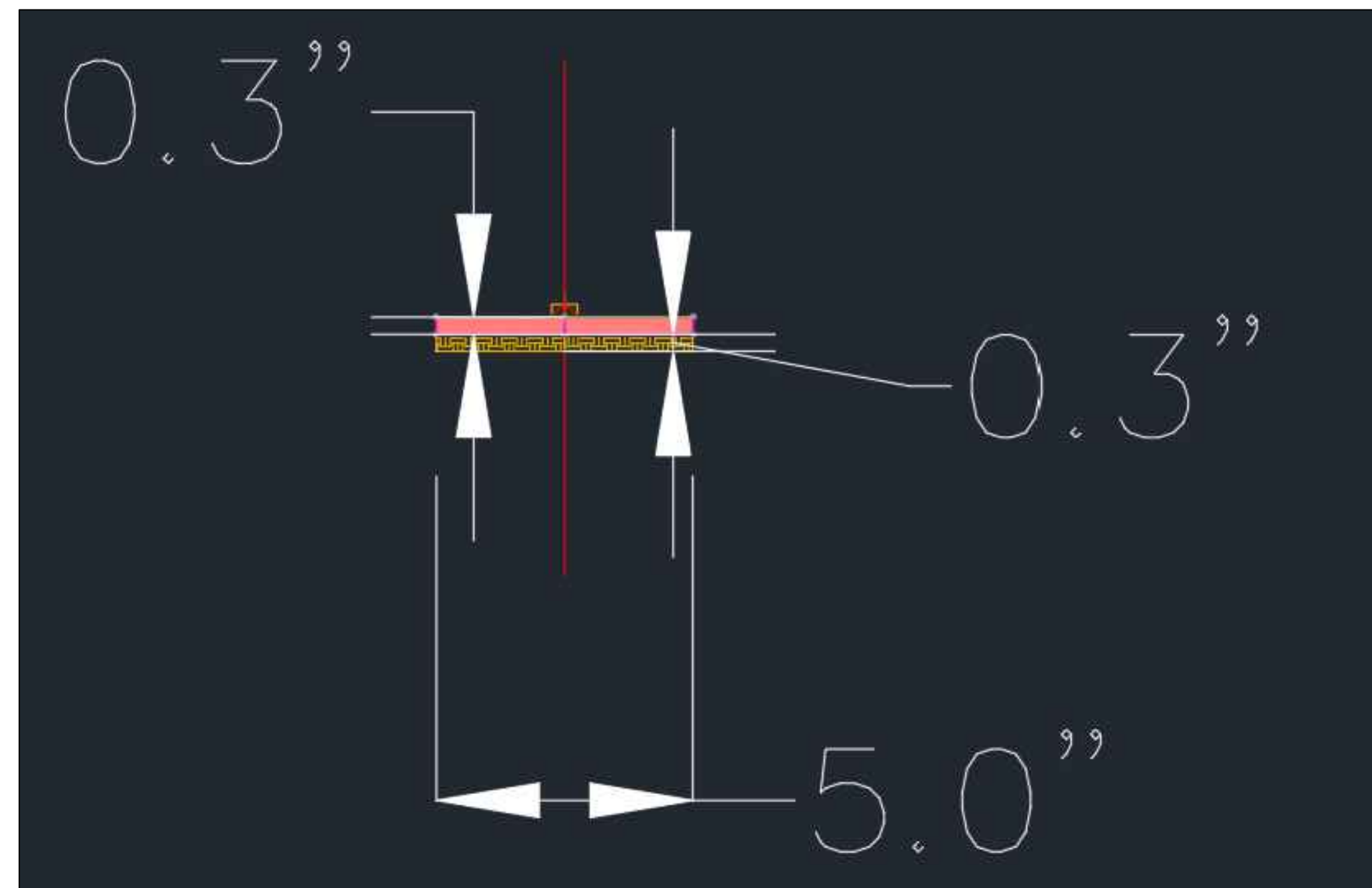

Detail F

6' Trail Cross Section

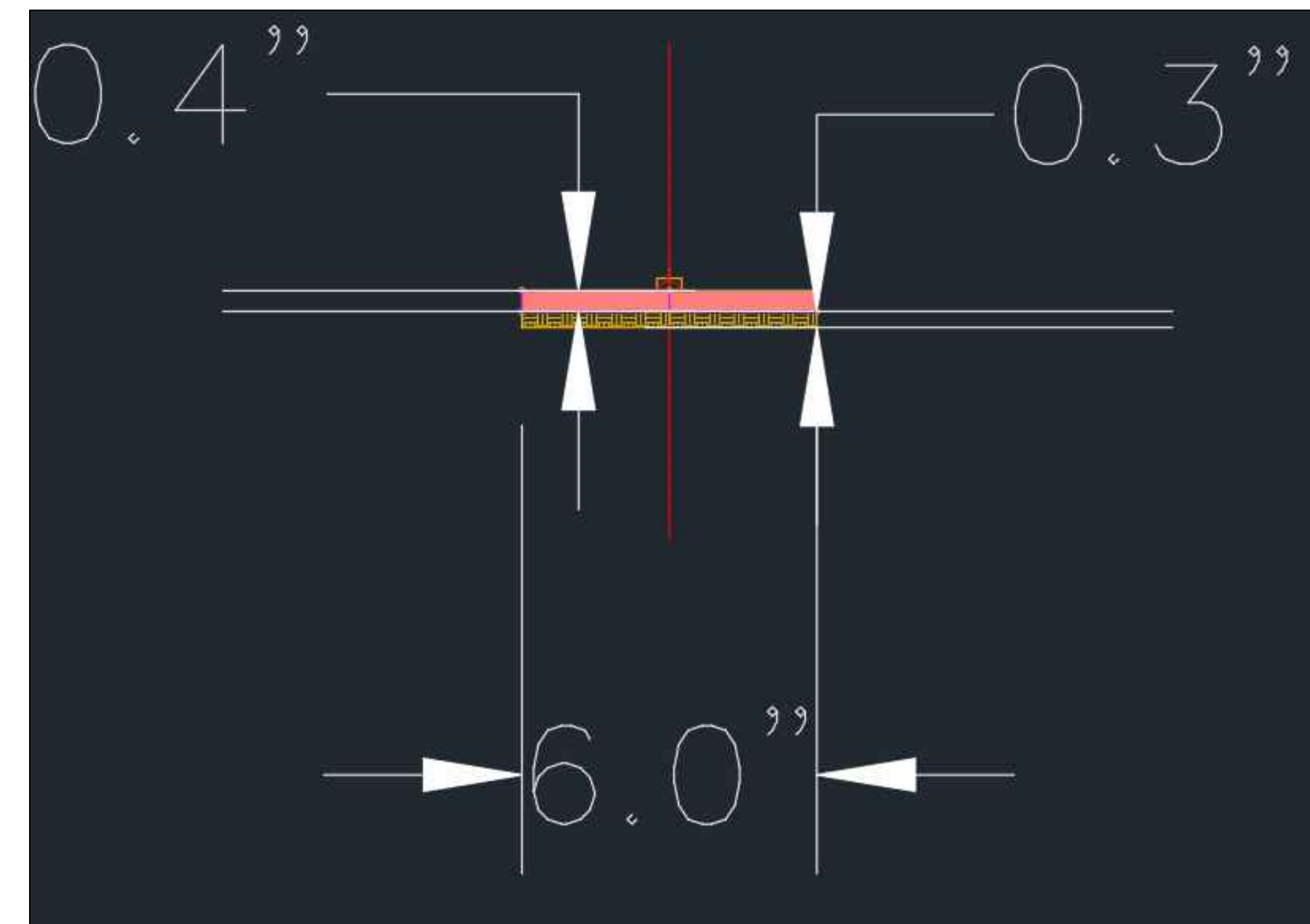

Detail G

5' Rebar Cross Section

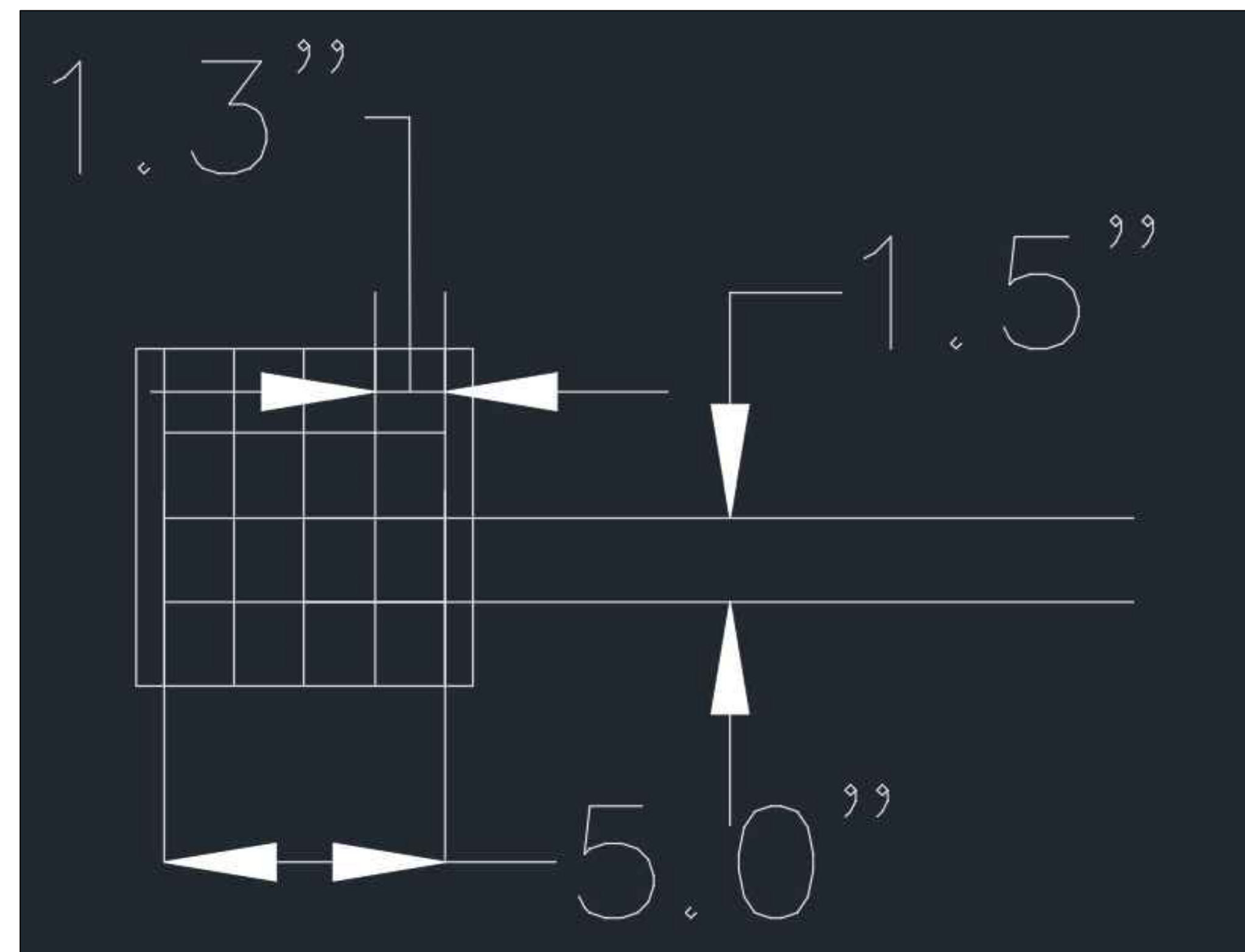

Detail H

6' Rebar Cross Section

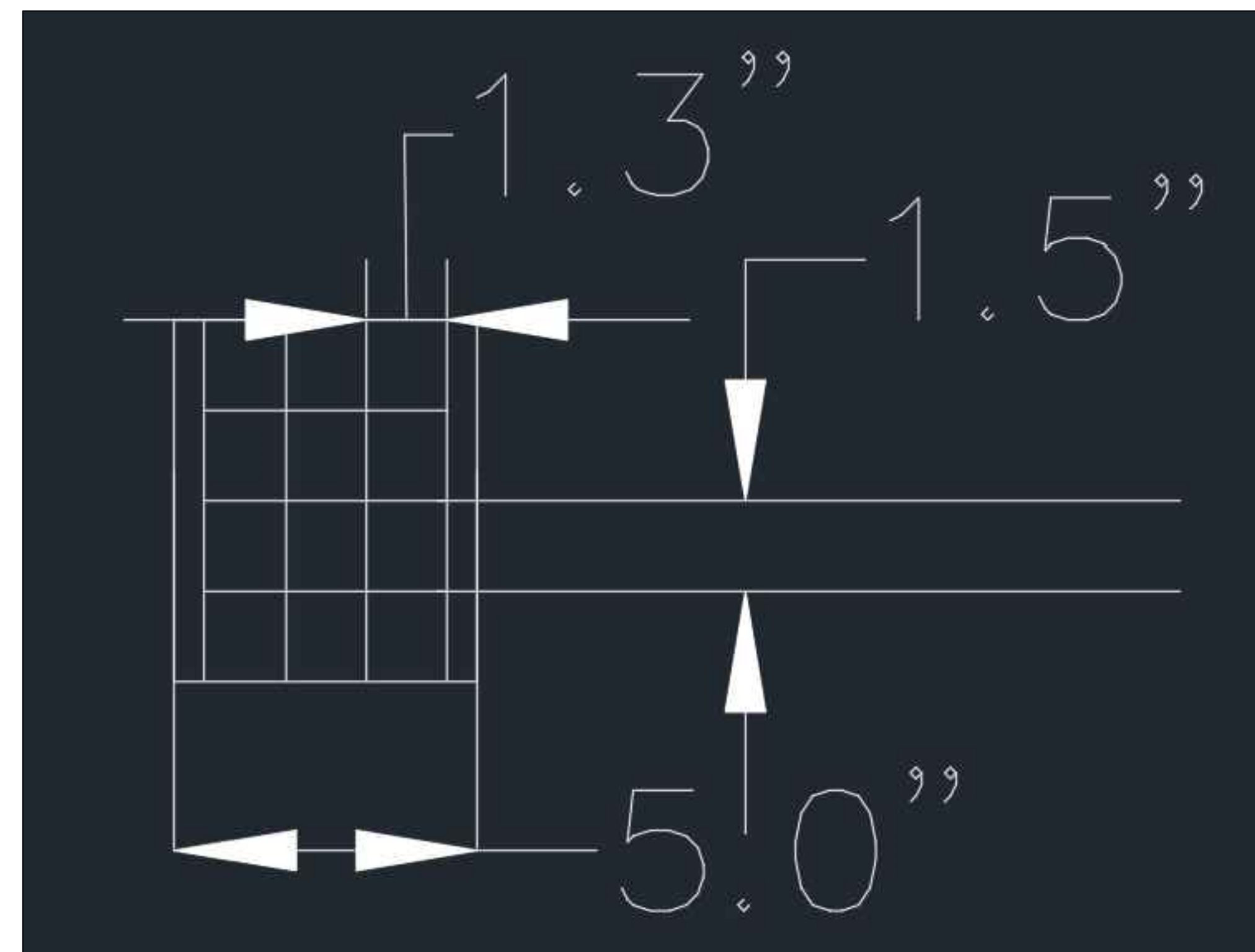

PROJECT:	CEE: 4850
DATE :	5-05-2022
DRAWN BY:	EF
REVISION:	

**THE UNIVERSITY OF IOWA**  
**CIVIL AND ENVIRONMENTAL ENGINEERING**  
 4105 SEAMANS CENTER FOR THE  
 ENGINEERING ARTS AND SCIENCES  
 103 S CAPITOL ST  
 IOWA CITY, IOWA 52242  
 PHONE: 319.335.5647  
 FAX: 319.335.5660  
 EMAIL: civil-hawks@iowa.edu

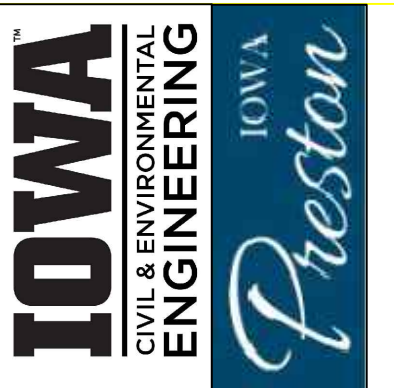

EDUCATIONAL - NOT FOR CONSTRUCTION

**Preston Connectivity**  
 City Of Preston  
 PROJECT ADDRESS 2

SHEET NAME  
 DETAIL

SHEET NO.  
**3**

Detail I  
No Parking Signage



Detail J  
Pedestrian Signage



Detail K  
Flashing Beacon

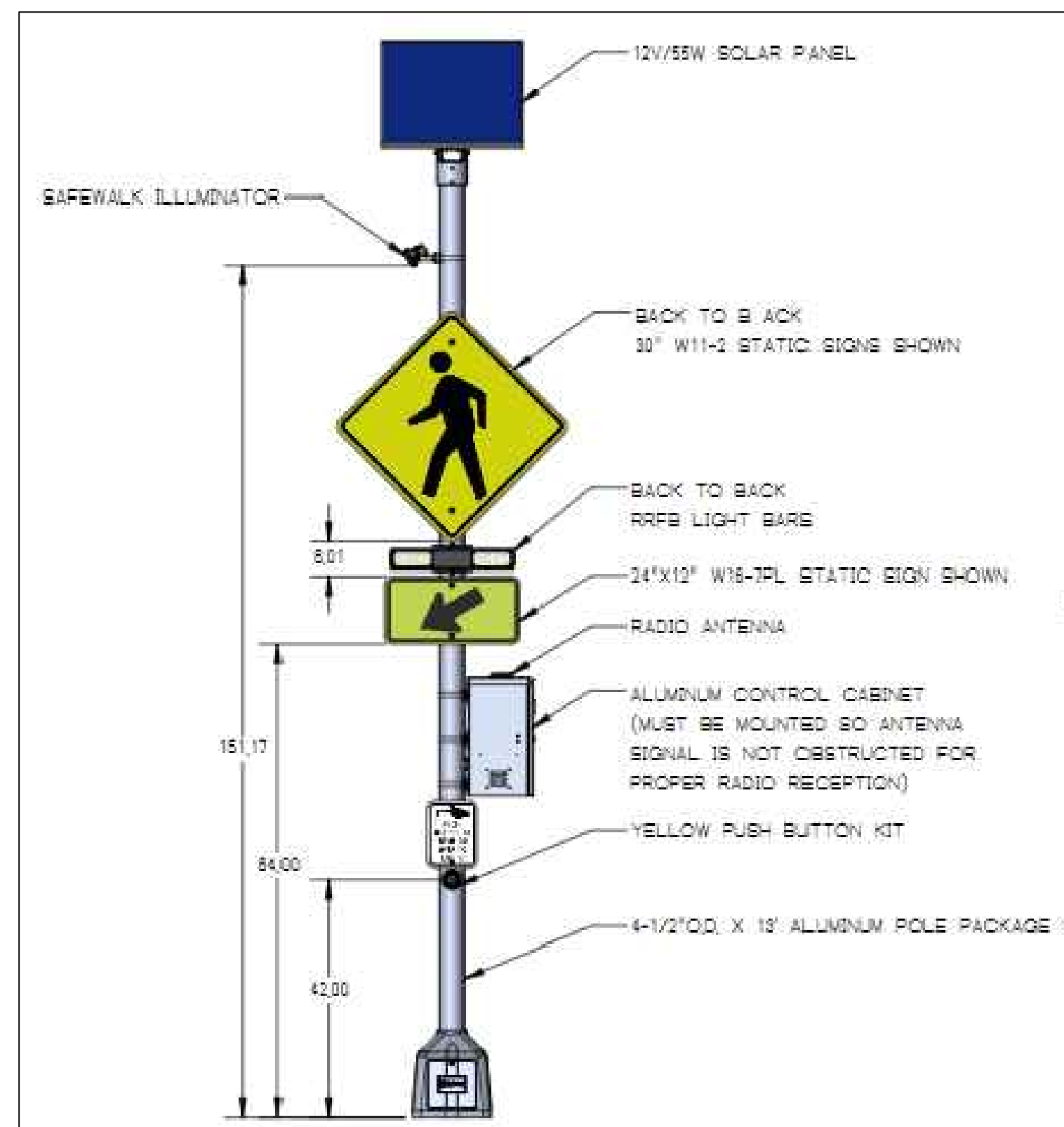

Detail L  
Object Marker Signage

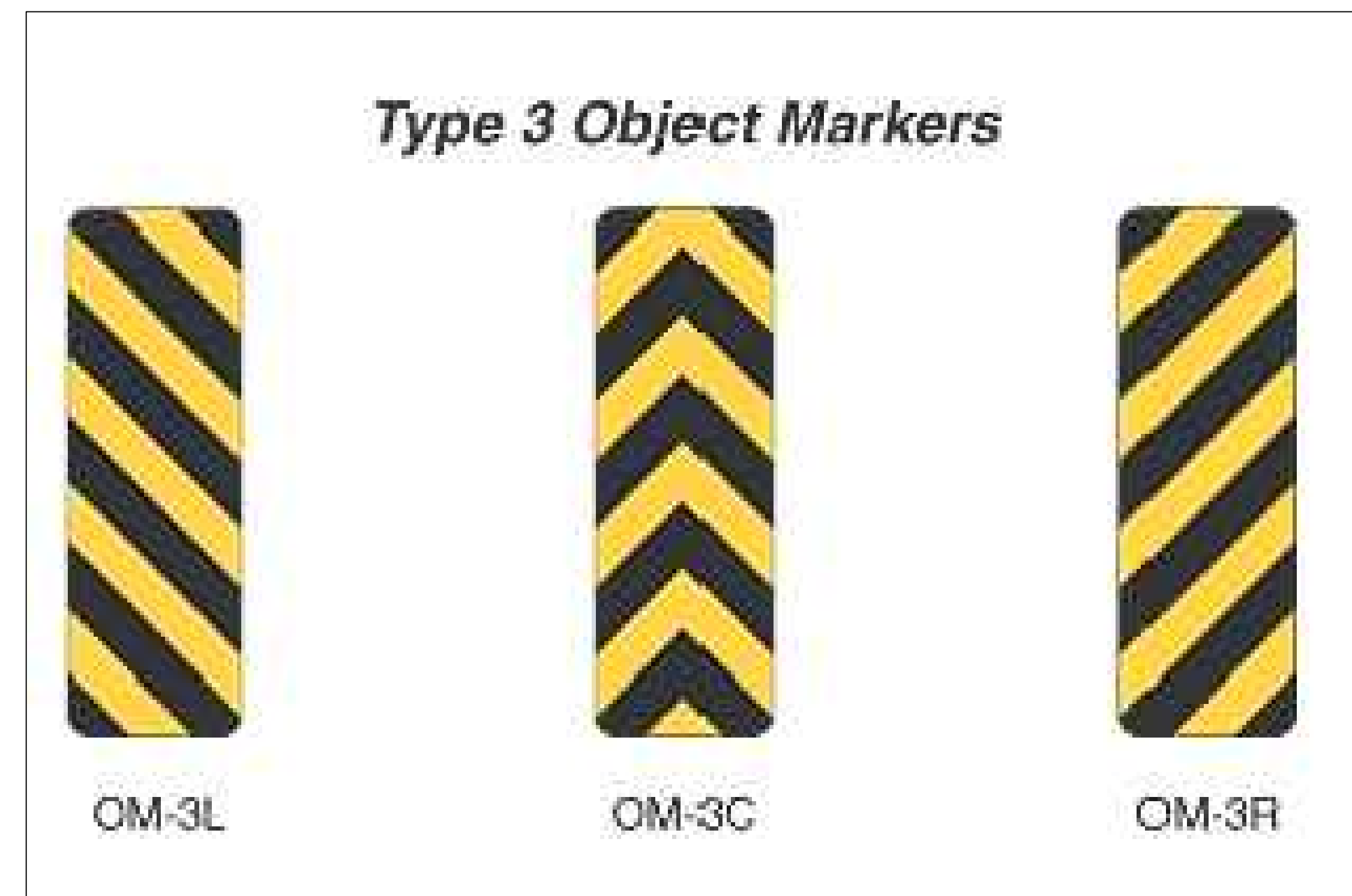

PROJECT:	CEE: 4850
DATE :	5-05-2022
DRAWN BY:	EF
REVISION:	

THE UNIVERSITY OF IOWA  
CIVIL AND ENVIRONMENTAL ENGINEERING  
4105 SEAMANS CENTER FOR THE  
ENGINEERING ARTS AND SCIENCES  
103 S CAPITOL ST  
IOWA CITY, IOWA 52242  
PHONE: 319.335.5647  
FAX: 319.335.5660  
EMAIL: civil-hawks@iowa.edu



EDUCATIONAL - NOT FOR CONSTRUCTION

**Preston Connectivity**  
City Of Preston  
PROJECT ADDRESS 2

SHEET NAME  
DETAIL

SHEET NO.  
**4**

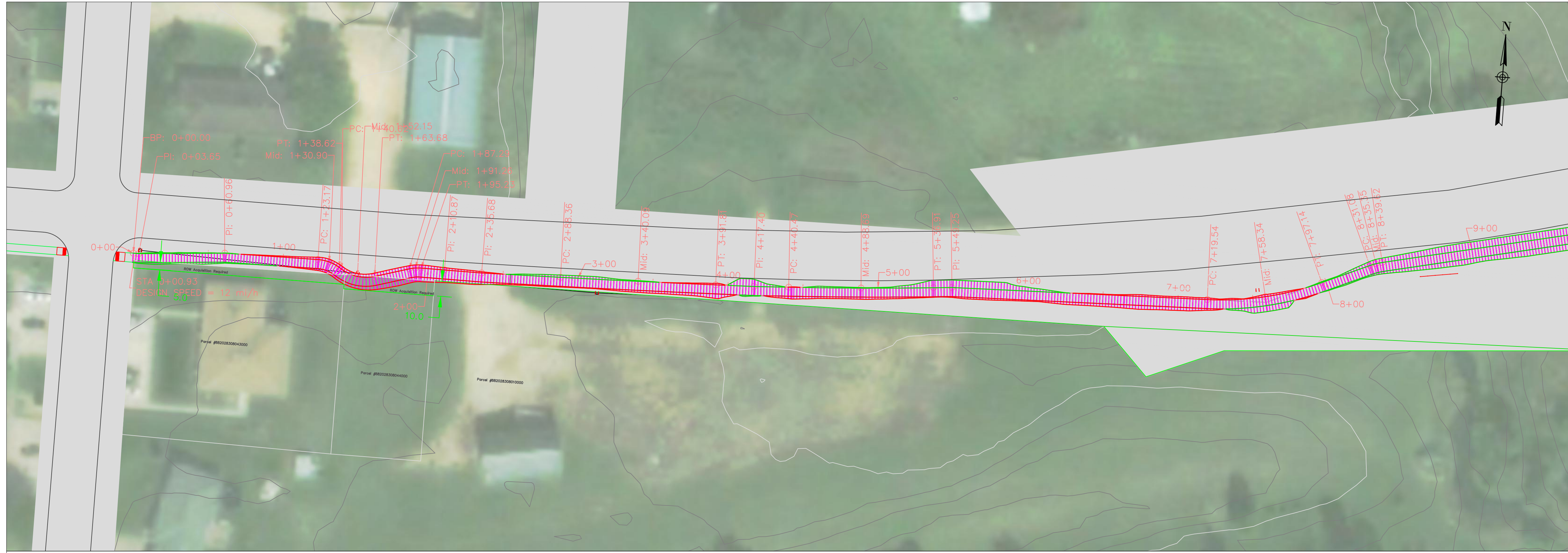

Highway64SidePath PROFILE

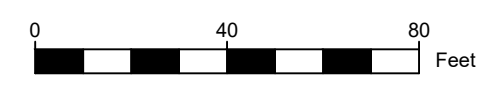
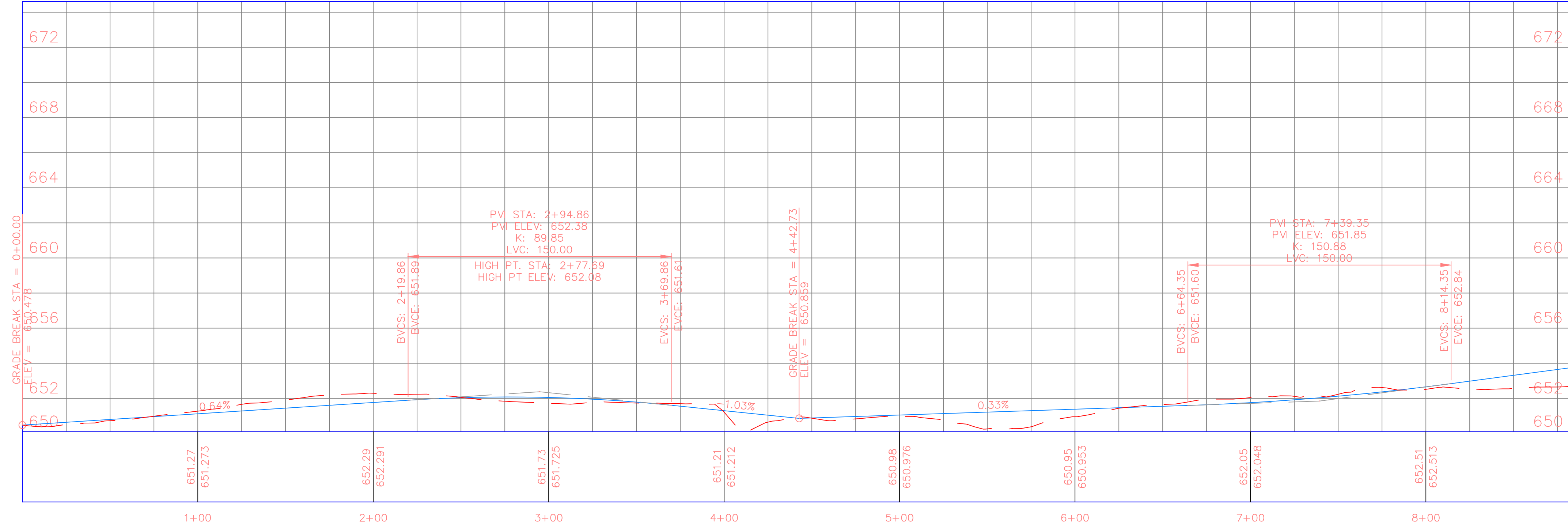

PROJECT:	CEE: 4850
DATE :	5-05-22
DRAWN BY:	Hannah DeBruin
REVISION:	

**THE UNIVERSITY OF IOWA**  
**CIVIL AND ENVIRONMENTAL ENGINEERING**  
 4105 SEAMANS CENTER FOR THE  
 ENGINEERING ARTS AND SCIENCES  
 103 S CAPITOL ST  
 IOWA CITY, IOWA 52242  
 PHONE: 319.335.5647  
 FAX: 319.335.5660  
 EMAIL: civil-hawks@iowa.edu



EDUCATIONAL - NOT FOR CONSTRUCTION

**Preston Connectivity**  
 City Of Preston  
 Highway 64 Side Path

SHEET NAME  
 Hwy 64 Side Path  
 Part 1

SHEET NO.  
**5**



Highway64SidePath PROFILE

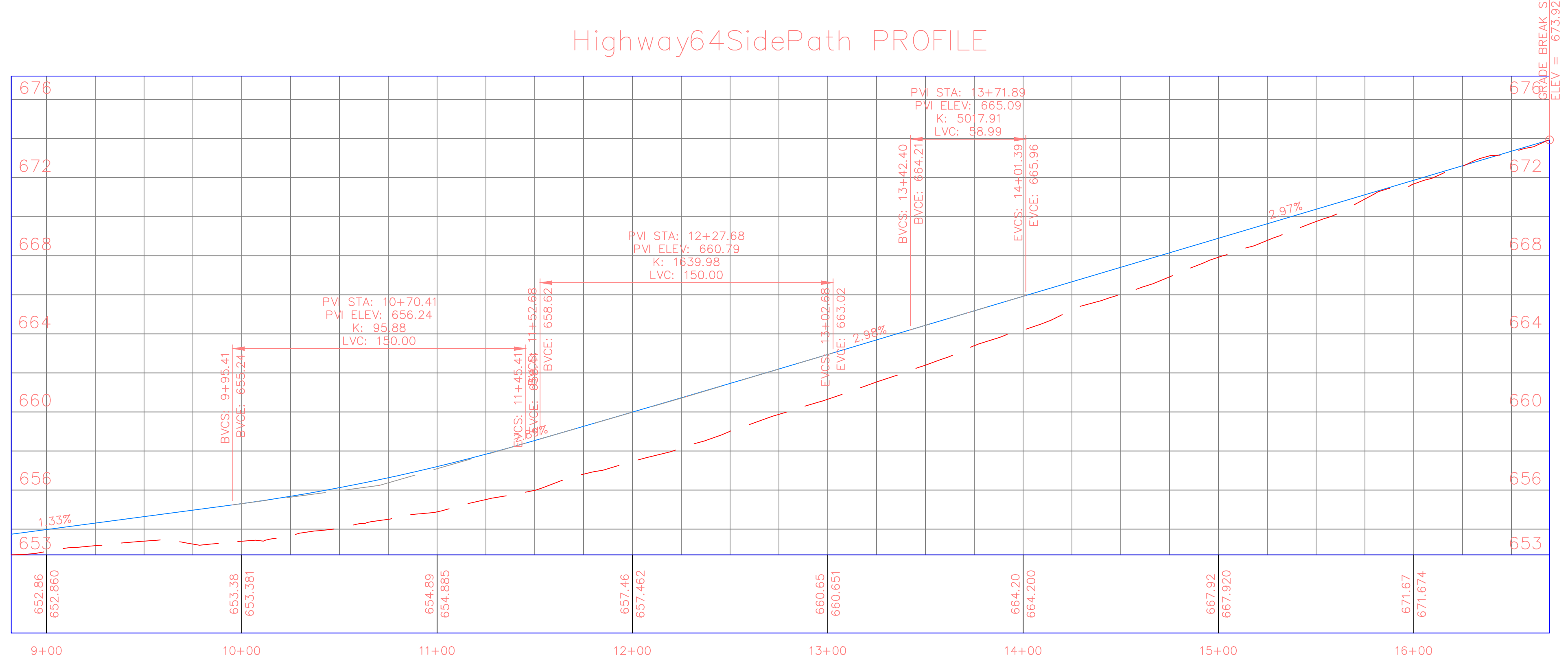

PROJECT:	CEE: 4850
DATE :	5-05-22
DRAWN BY:	Hannah DeBruin
REVISION:	

**THE UNIVERSITY OF IOWA**  
**CIVIL AND ENVIRONMENTAL ENGINEERING**  
 4105 SEAMANS CENTER FOR THE  
 ENGINEERING ARTS AND SCIENCES  
 103 S CAPITOL ST  
 IOWA CITY, IOWA 52242  
 PHONE: 319.335.5647  
 FAX: 319.335.5660  
 EMAIL: civil-hawks@iowa.edu



EDUCATIONAL - NOT FOR CONSTRUCTION

**Preston Connectivity**  
 City Of Preston  
 Highway 64 Side Path

SHEET NAME  
 Hwy 64 Side Path  
 Part 2

SHEET NO.  
**6**

Winter Street

Highway 64



PROJECT:	CEE: 4850
DATE :	5-05-22
DRAWN BY:	Hannah DeBruin
REVISION:	

**THE UNIVERSITY OF IOWA**  
**CIVIL AND ENVIRONMENTAL ENGINEERING**  
 4105 SEAMANS CENTER FOR THE  
 ENGINEERING ARTS AND SCIENCES  
 103 S CAPITOL ST  
 IOWA CITY, IOWA 52242  
 PHONE: 319.335.5647  
 FAX: 319.335.5660  
 EMAIL: civil-hawks@iowa.edu

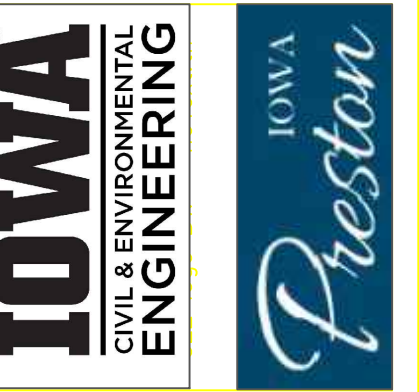

EDUCATIONAL - NOT FOR CONSTRUCTION

**Preston Connectivity**

City Of Preston  
Highway 64 Details Near Winter Street

SHEET NAME

Hwy 64 near Winter Street

SHEET NO.

7

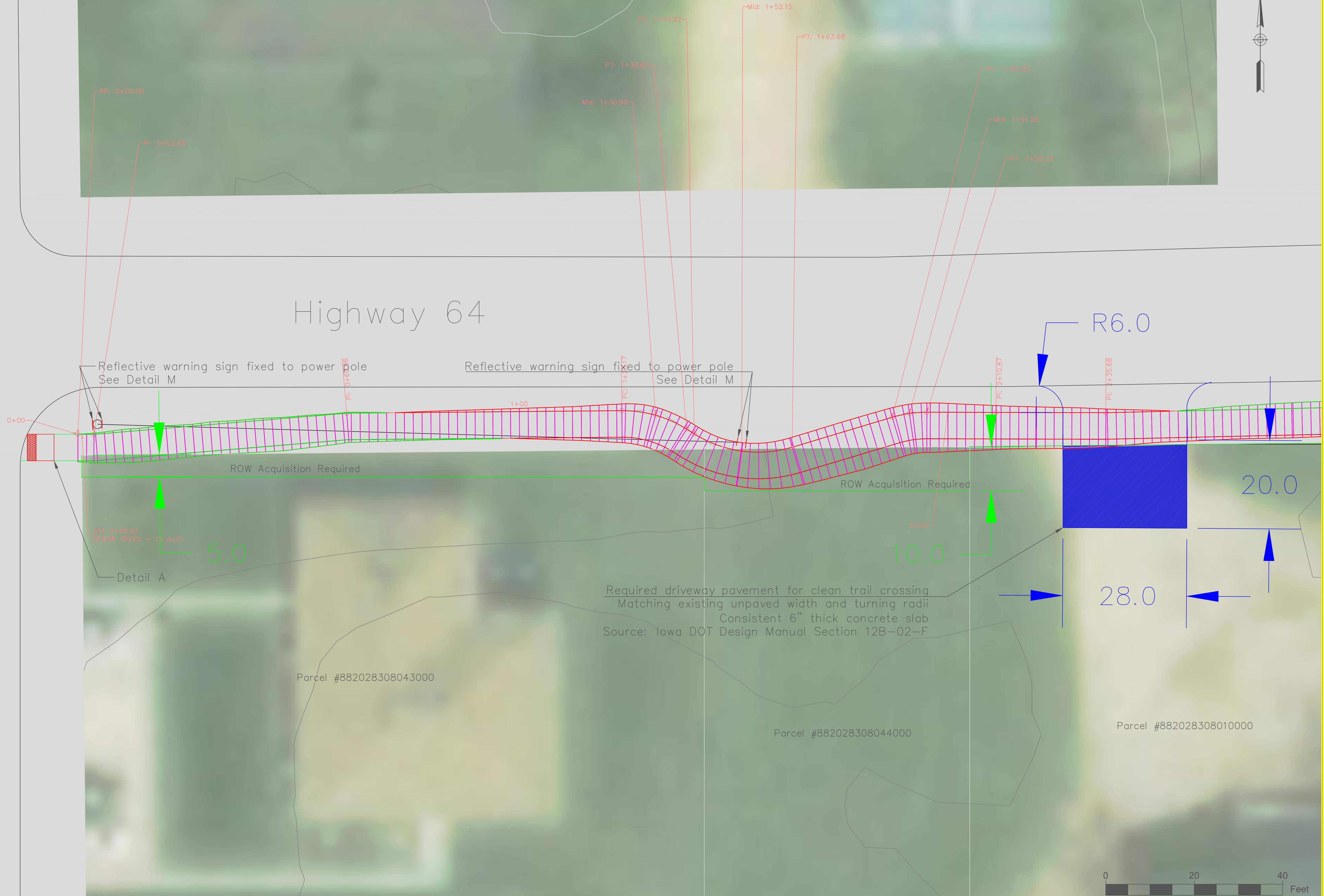

# Guardrail for Culvert

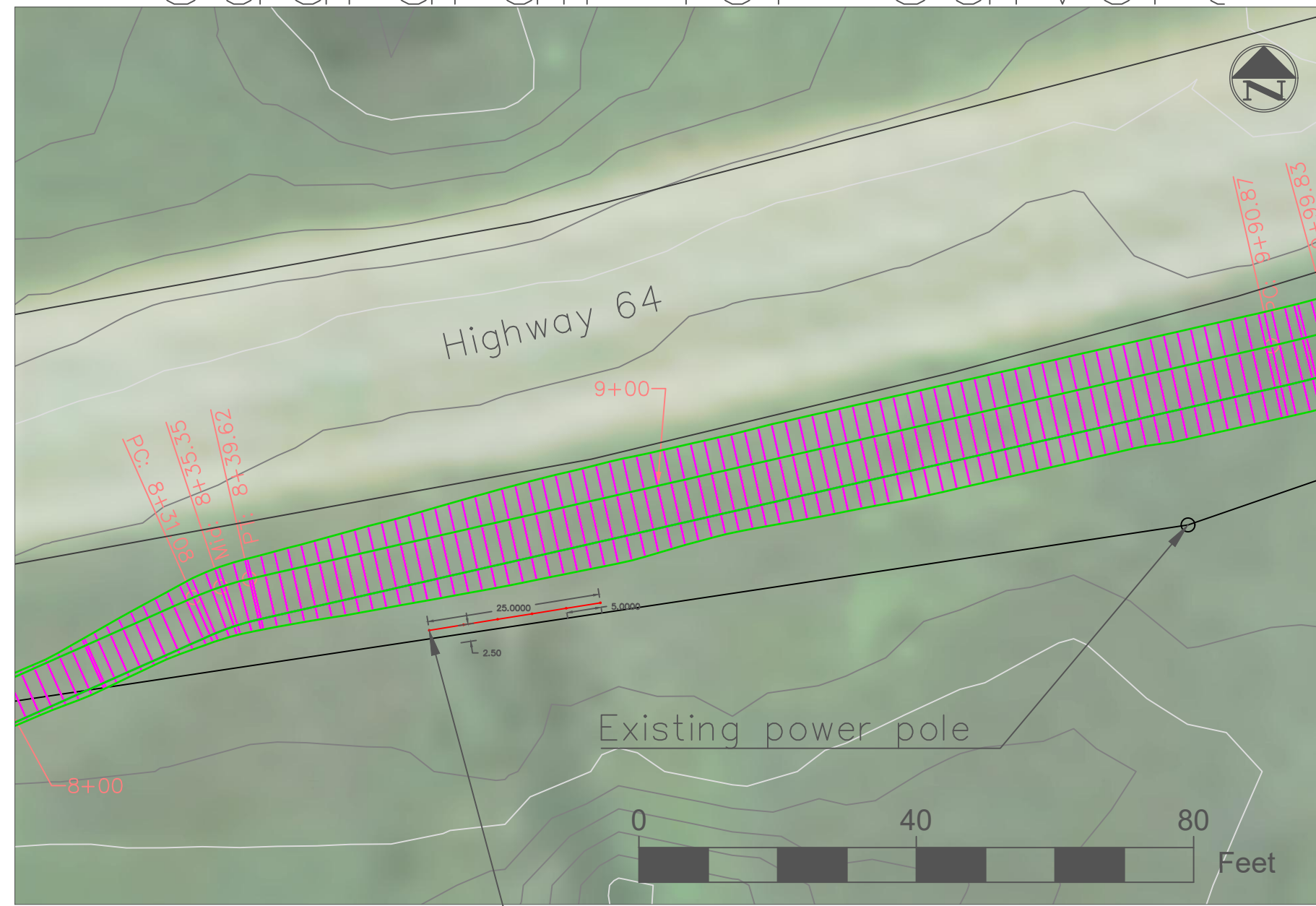

Guard rail over culvert  
See Detail D

# Highway 64 & Mitchell Street



# Highway 64 & Main Street

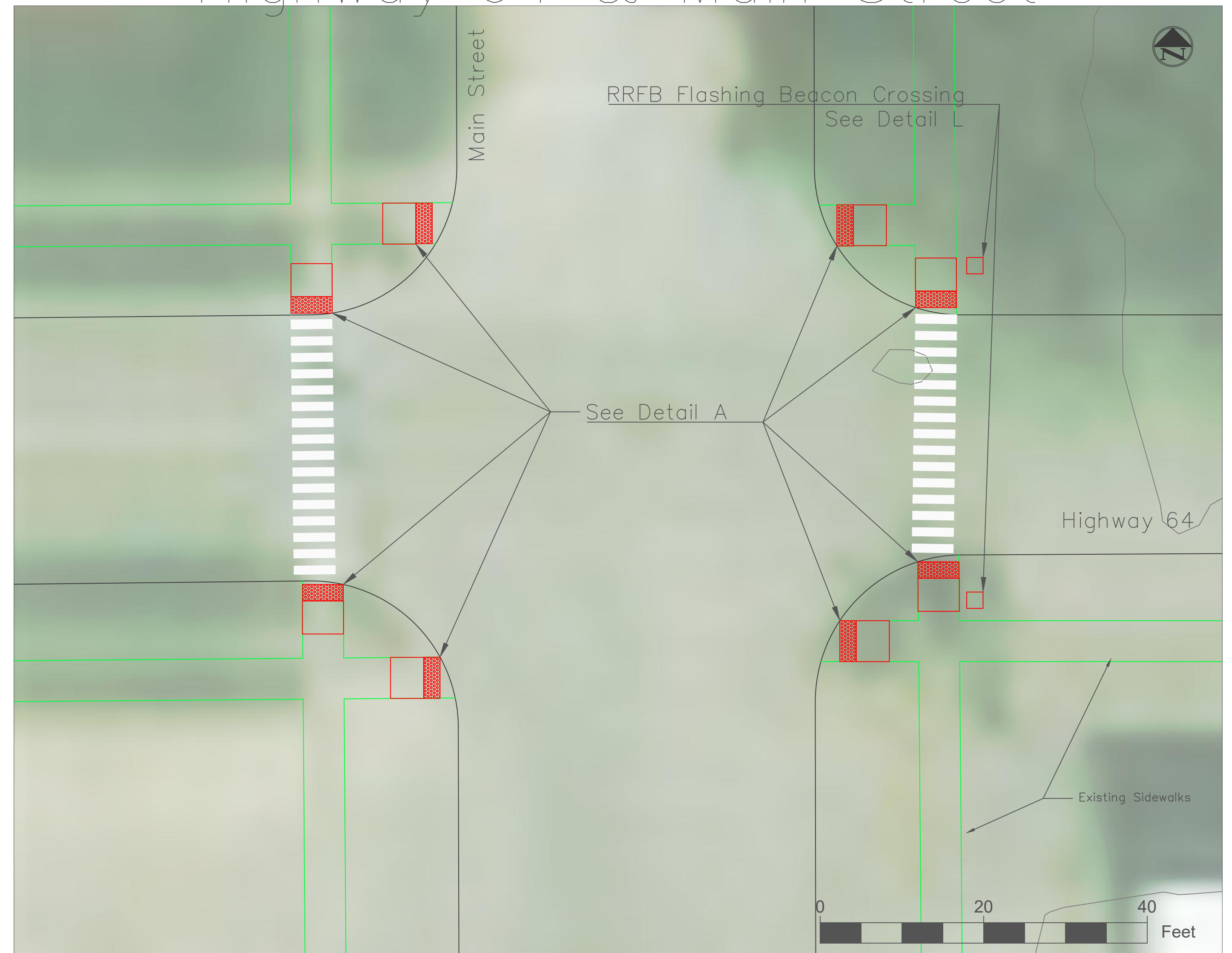

PROJECT:	CEE: 4850
DATE :	5-05-22
DRAWN BY:	Hannah DeBruin
REVISION:	

**THE UNIVERSITY OF IOWA**  
**CIVIL AND ENVIRONMENTAL ENGINEERING**  
 4105 SEAMANS CENTER FOR THE  
 ENGINEERING ARTS AND SCIENCES  
 103 S CAPITOL ST  
 IOWA CITY, IOWA 52242  
 PHONE: 319.335.5647  
 FAX: 319.335.5660  
 EMAIL: civil-hawks@iowa.edu

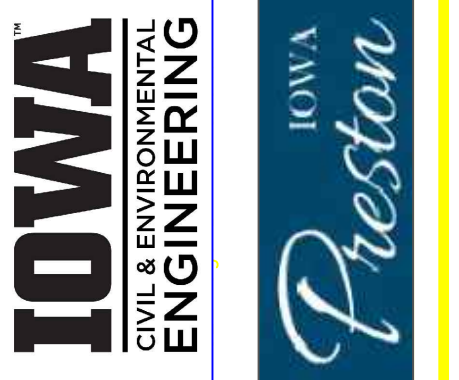

EDUCATIONAL - NOT FOR CONSTRUCTION

**Preston Connectivity**  
 City Of Preston  
 Highway 64 Crossings and Guardrail Placement

SHEET NAME  
 Hwy 64 Crossings & Guardrail

SHEET NO.  
**8**



# Trail Alternative 1



\*Speed limit sign placement using Iowa DOT Traffic Manual Section 2-08 Guidance

# Trail Alternative 2



# Trail Alternative 3



# Trail Alternative 4



PROJECT:	CEE: 4850
DATE :	5-05-22
DRAWN BY:	Hannah DeBruin
REVISION:	

**THE UNIVERSITY OF IOWA**  
**CIVIL AND ENVIRONMENTAL ENGINEERING**  
 4105 SEAMANS CENTER FOR THE  
 ENGINEERING ARTS AND SCIENCES  
 103 S CAPITOL ST  
 IOWA CITY, IOWA 52242  
 PHONE: 319.335.5647  
 FAX: 319.335.5660  
 EMAIL: civil-hawks@iowa.edu

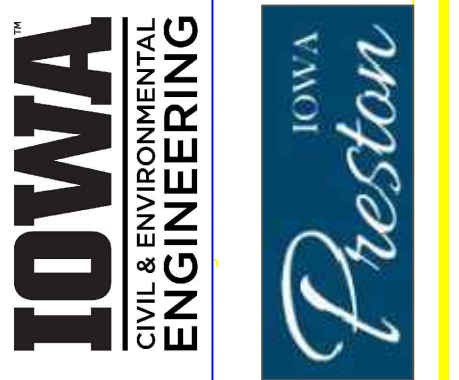

EDUCATIONAL - NOT FOR CONSTRUCTION

**Preston Connectivity**  
 City Of Preston  
 Copper Creek Trail Alternative Crossings

SHEET NAME  
 Copper Creek  
 Alt. Crossings

SHEET NO.  
**9**

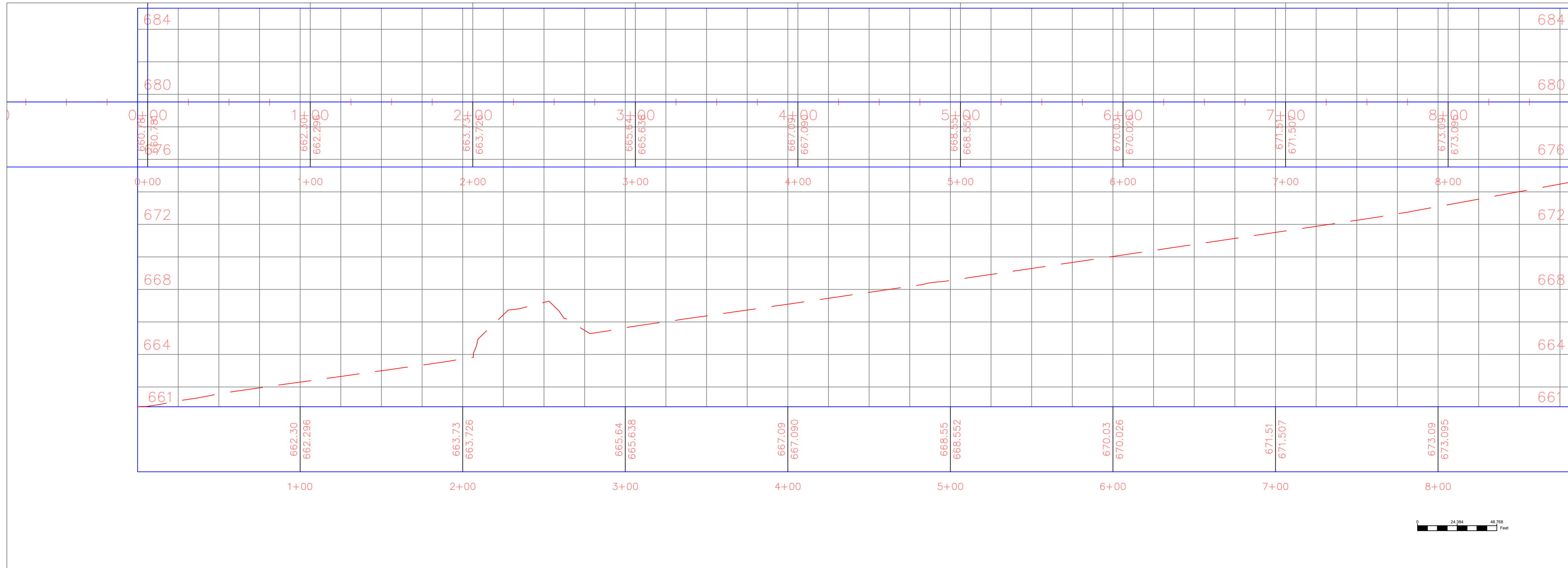
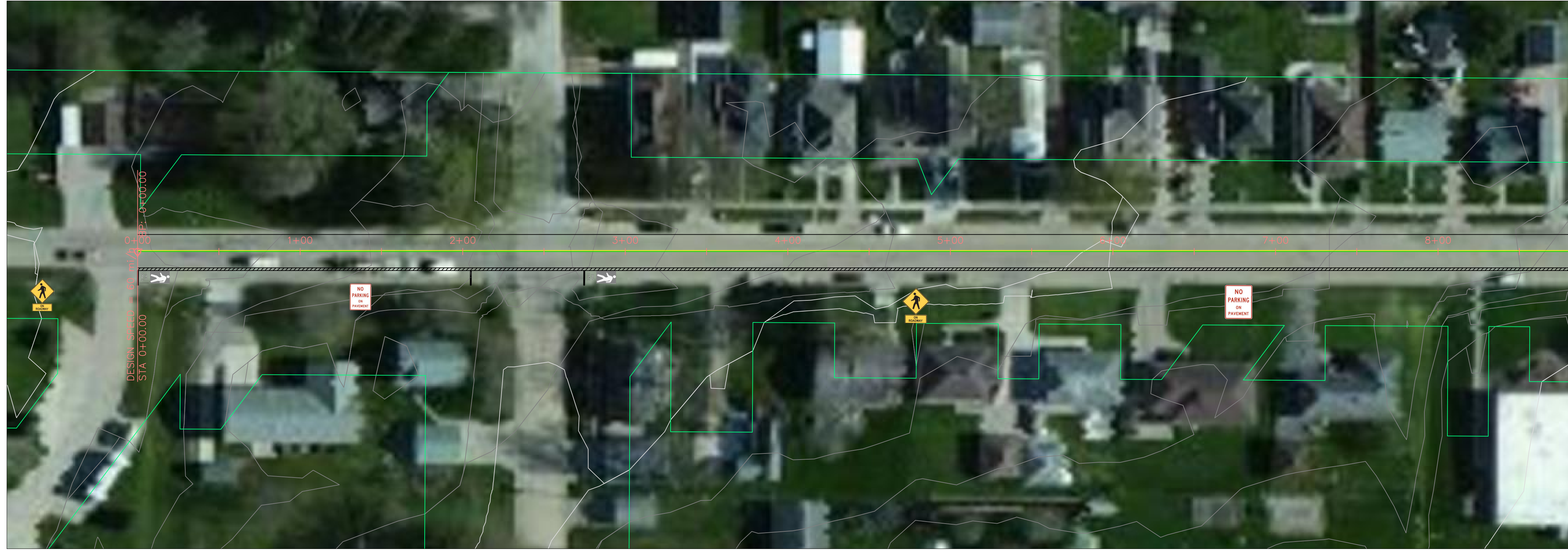

PROJECT:	CEE: 4850
DATE :	5/05/2022
DRAWN BY:	KB
REVISION:	

**THE UNIVERSITY OF IOWA**  
**CIVIL AND ENVIRONMENTAL ENGINEERING**  
 4105 SEAMANS CENTER FOR THE  
 ENGINEERING ARTS AND SCIENCES  
 103 S CAPITOL ST  
 IOWA CITY, IOWA 52242  
 PHONE: 319.335.5647  
 FAX: 319.335.5660  
 EMAIL: civil-hawks@iowa.edu

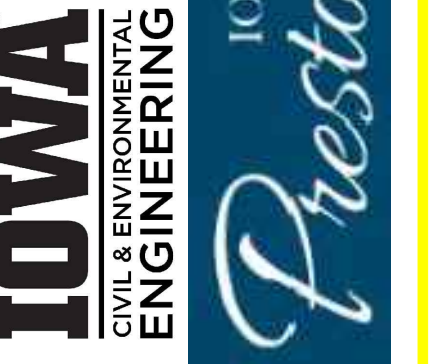

EDUCATIONAL - NOT FOR CONSTRUCTION

**Preston Connectivity**  
 City Of Preston  
 School St. Alternative 1 Pt 1

SHEET NAME  
 School St.  
 Alternative 1 Pt 1

SHEET NO.  
**10**

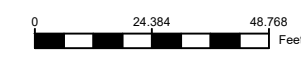
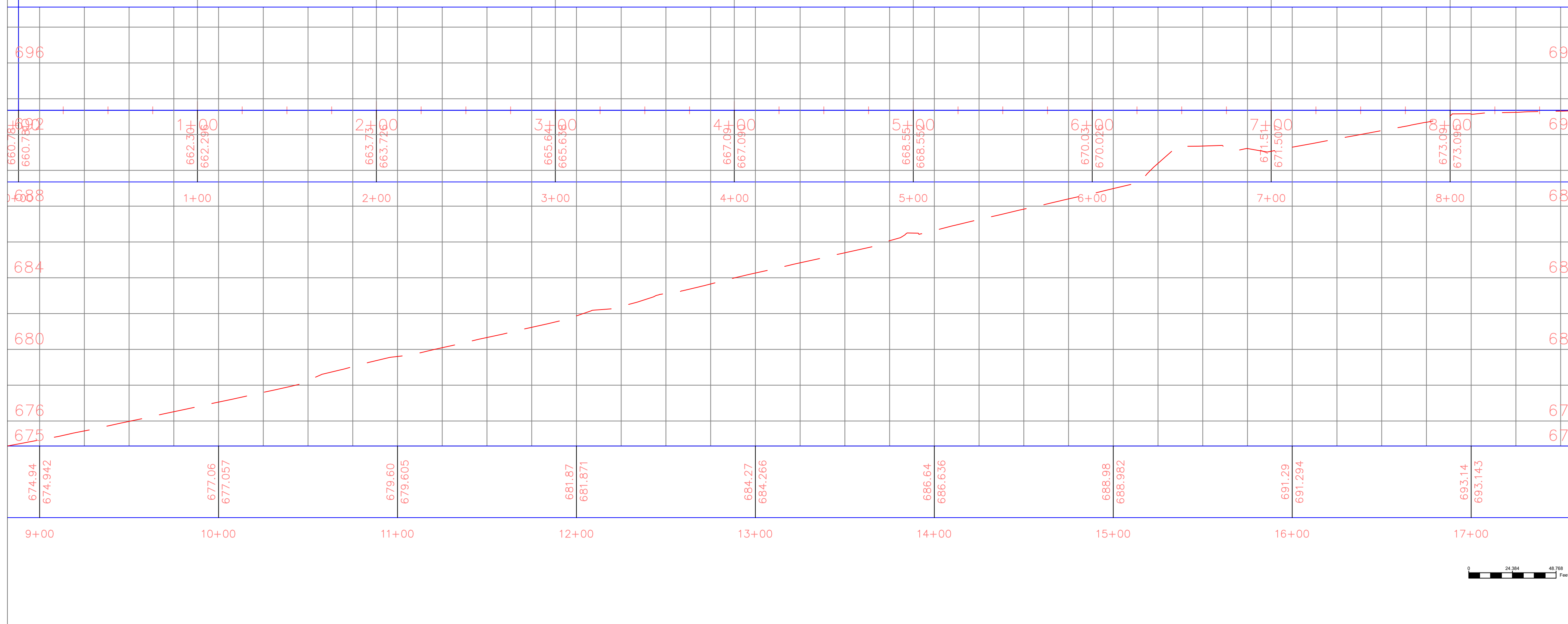

PROJECT:	CEE: 4850
DATE :	5-05-2022
DRAWN BY:	KB
REVISION:	

**THE UNIVERSITY OF IOWA**  
**CIVIL AND ENVIRONMENTAL ENGINEERING**  
 4105 SEAMANS CENTER FOR THE  
 ENGINEERING ARTS AND SCIENCES  
 103 S CAPITOL ST  
 IOWA CITY, IOWA 52242  
 PHONE: 319.335.5647  
 FAX: 319.335.5660  
 EMAIL: civil-hawks@iowa.edu



EDUCATIONAL - NOT FOR CONSTRUCTION

**Preston Connectivity**  
 City Of Preston  
 School St. Alternative 1 Pt 2

SHEET NAME  
 School St  
 Altrnative 1 Pt 2

SHEET NO.  
**11**

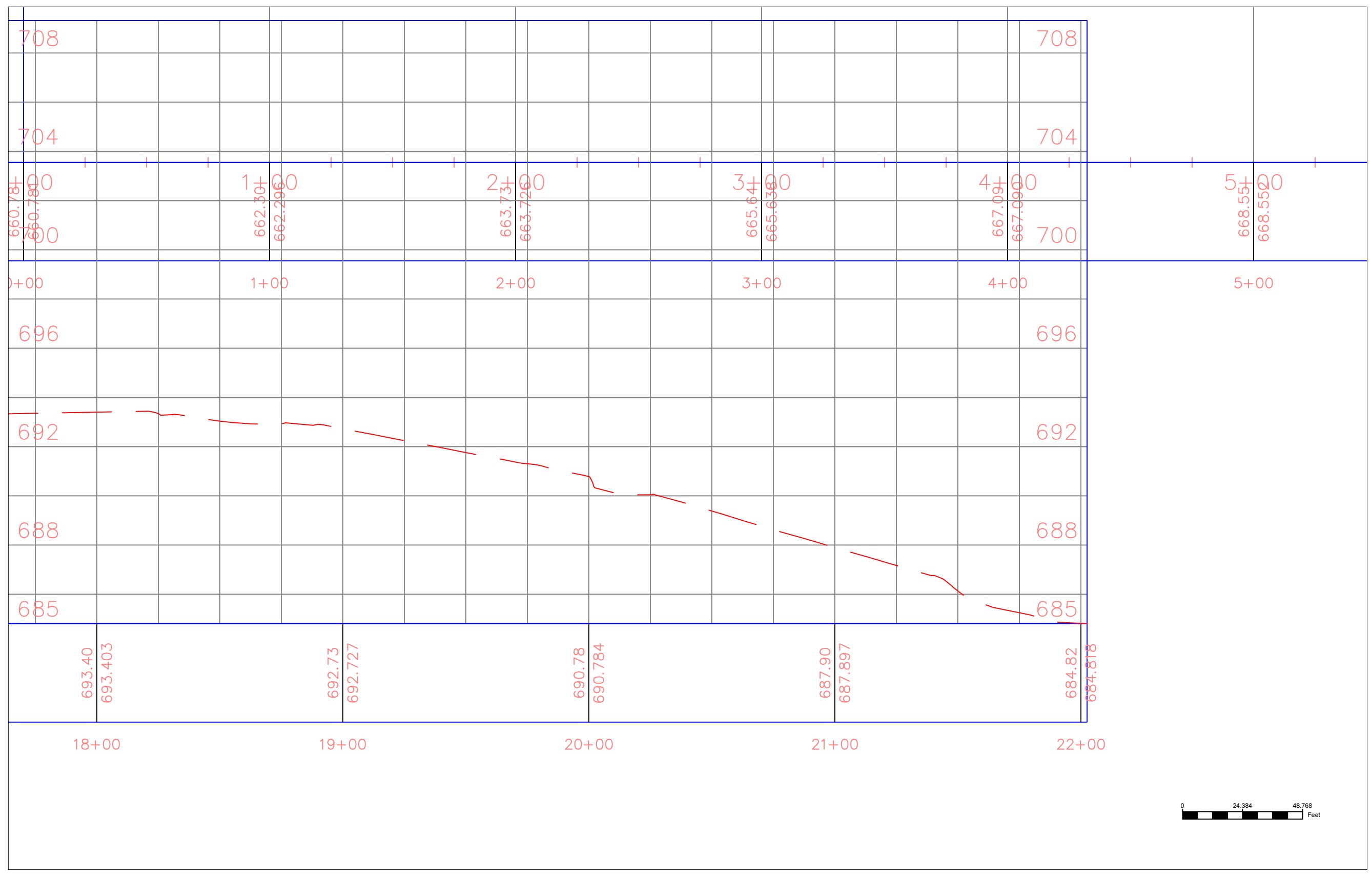
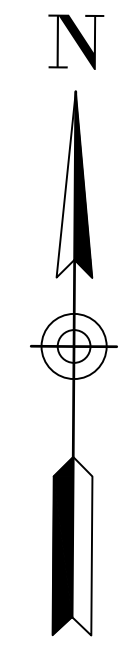

PROJECT:	CEE: 4850
DATE :	5-05-2022
DRAWN BY:	KB
REVISION:	

**THE UNIVERSITY OF IOWA**  
**CIVIL AND ENVIRONMENTAL ENGINEERING**  
 4105 SEAMANS CENTER FOR THE  
 ENGINEERING ARTS AND SCIENCES  
 103 S CAPITOL ST  
 IOWA CITY, IOWA 52242  
 PHONE: 319.335.5647  
 FAX: 319.335.5660  
 EMAIL: civil-hawks@iowa.edu

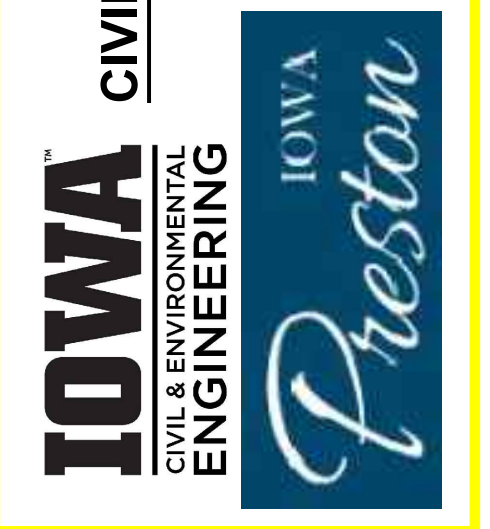

EDUCATIONAL - NOT FOR CONSTRUCTION

**Preston Connectivity**  
 City Of Preston  
 School St. Alternative 1 Pt 3

SHEET NAME  
 School St.  
 Alternative 1 Pt 3

SHEET NO.  
**12**

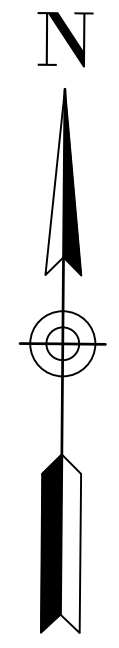
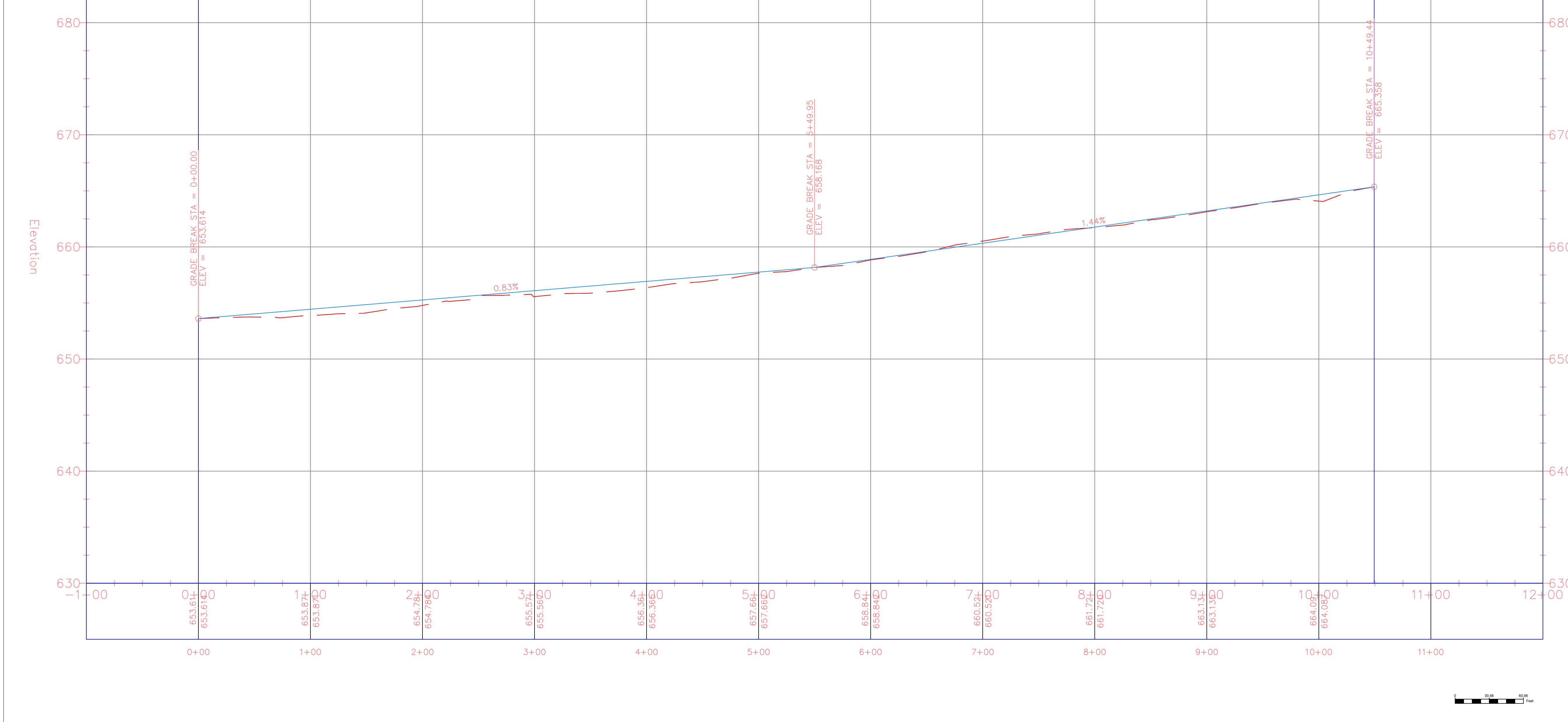

PROJECT:	CEE: 4850
DATE :	5-05-2022
DRAWN BY:	KB
REVISION:	

**THE UNIVERSITY OF IOWA**  
**CIVIL AND ENVIRONMENTAL ENGINEERING**  
 4105 SEAMANS CENTER FOR THE  
 ENGINEERING ARTS AND SCIENCES  
 103 S CAPITOL ST  
 IOWA CITY, IOWA 52242  
 PHONE: 319.335.5647  
 FAX: 319.335.5660  
 EMAIL: civil-hawks@iowa.edu



EDUCATIONAL - NOT FOR CONSTRUCTION

# Preston Connectivity

City Of Preston  
 School St. Alternative 2 Pt. 1

SHEET NAME  
 School St  
 Alternative 2 Pt 1

SHEET NO.  
**13**

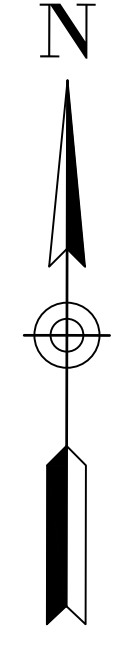
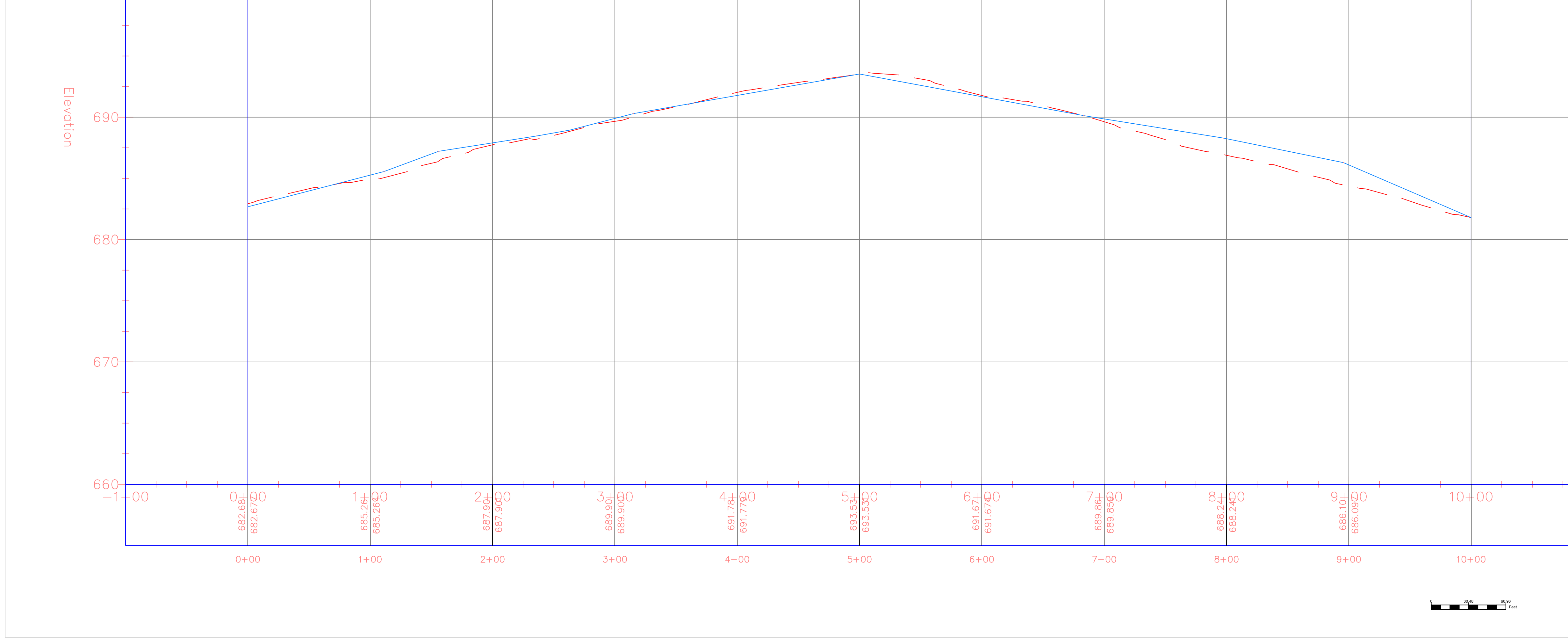

PROJECT:	CEE: 4850
DATE :	5-05-2022
DRAWN BY:	KB
REVISION:	

**THE UNIVERSITY OF IOWA**  
**CIVIL AND ENVIRONMENTAL ENGINEERING**  
 4105 SEAMANS CENTER FOR THE  
 ENGINEERING ARTS AND SCIENCES  
 103 S CAPITOL ST  
 IOWA CITY, IOWA 52242  
 PHONE: 319.335.5647  
 FAX: 319.335.5660  
 EMAIL: civil-hawks@iowa.edu

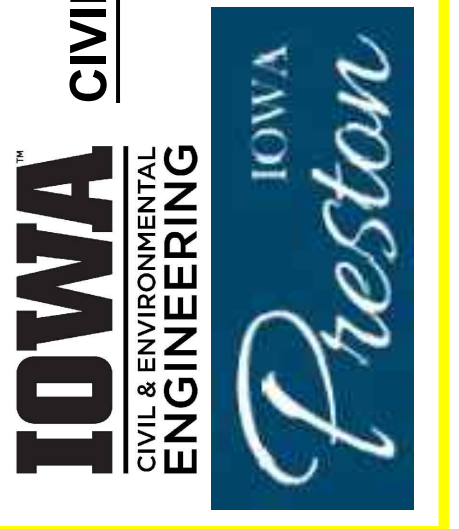

EDUCATIONAL - NOT FOR CONSTRUCTION

**Preston Connectivity**  
 City Of Preston  
 School St. Alternative 2 Pt. 2

SHEET NAME  
 School St.  
 Alternative 2 Pt 2

SHEET NO.  
**14**

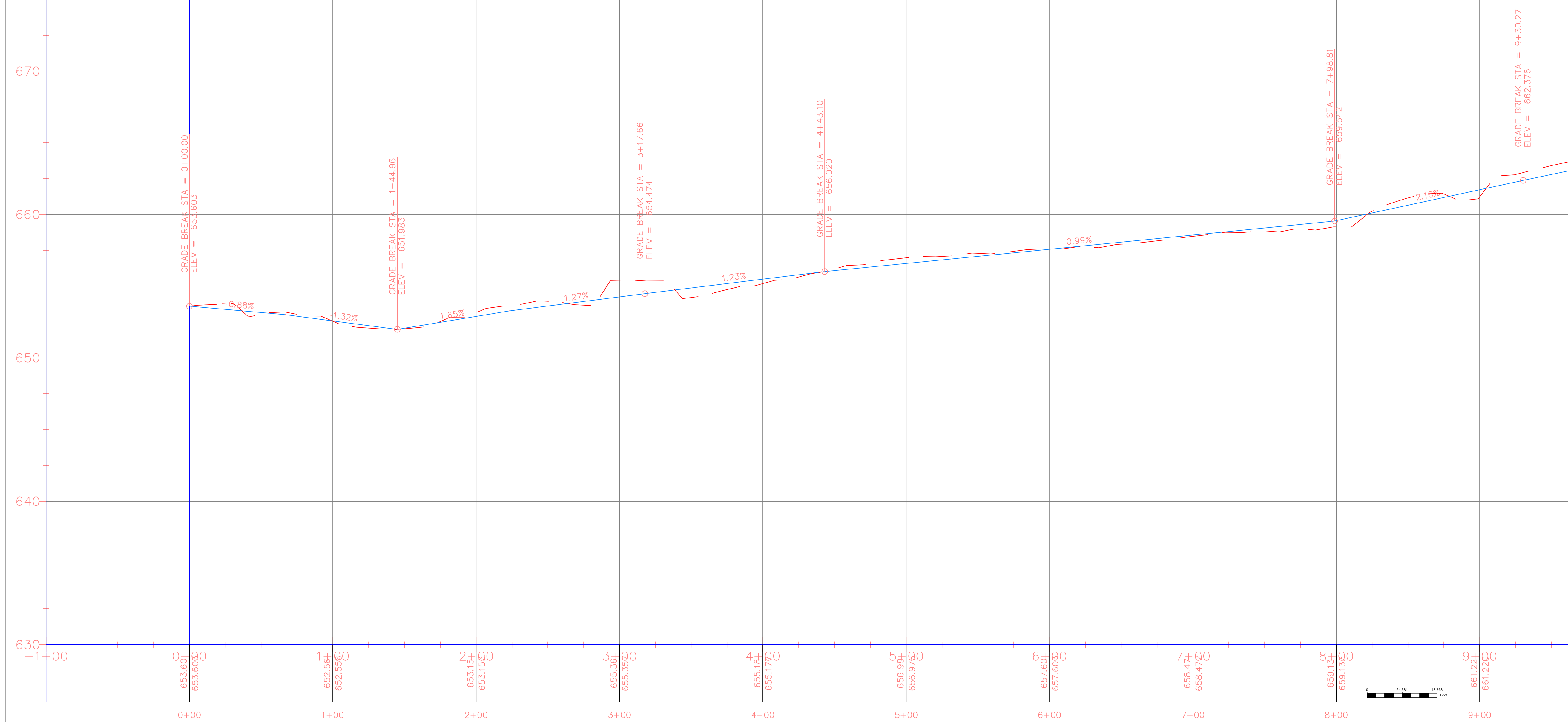
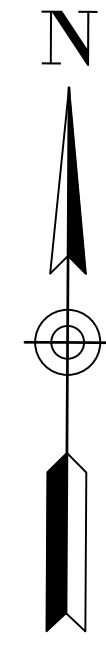

PROJECT:	CEE: 4850
DATE :	5-05-2022
DRAWN BY:	KB
REVISION:	

**THE UNIVERSITY OF IOWA**  
**CIVIL AND ENVIRONMENTAL ENGINEERING**  
 4105 SEAMANS CENTER FOR THE  
 ENGINEERING ARTS AND SCIENCES  
 103 S CAPITOL ST  
 IOWA CITY, IOWA 52242  
 PHONE: 319.335.5647  
 FAX: 319.335.5660  
 EMAIL: civil-hawks@iowa.edu



EDUCATIONAL - NOT FOR CONSTRUCTION

**Preston Connectivity**  
 City Of Preston  
 School St. Alternative 3 Pt. 1

SHEET NAME  
 School St  
 Alternative 3 Pt 1

SHEET NO.  
**15**

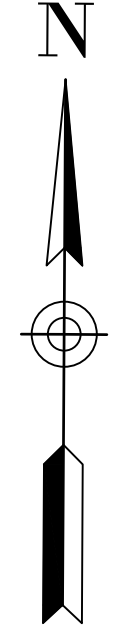
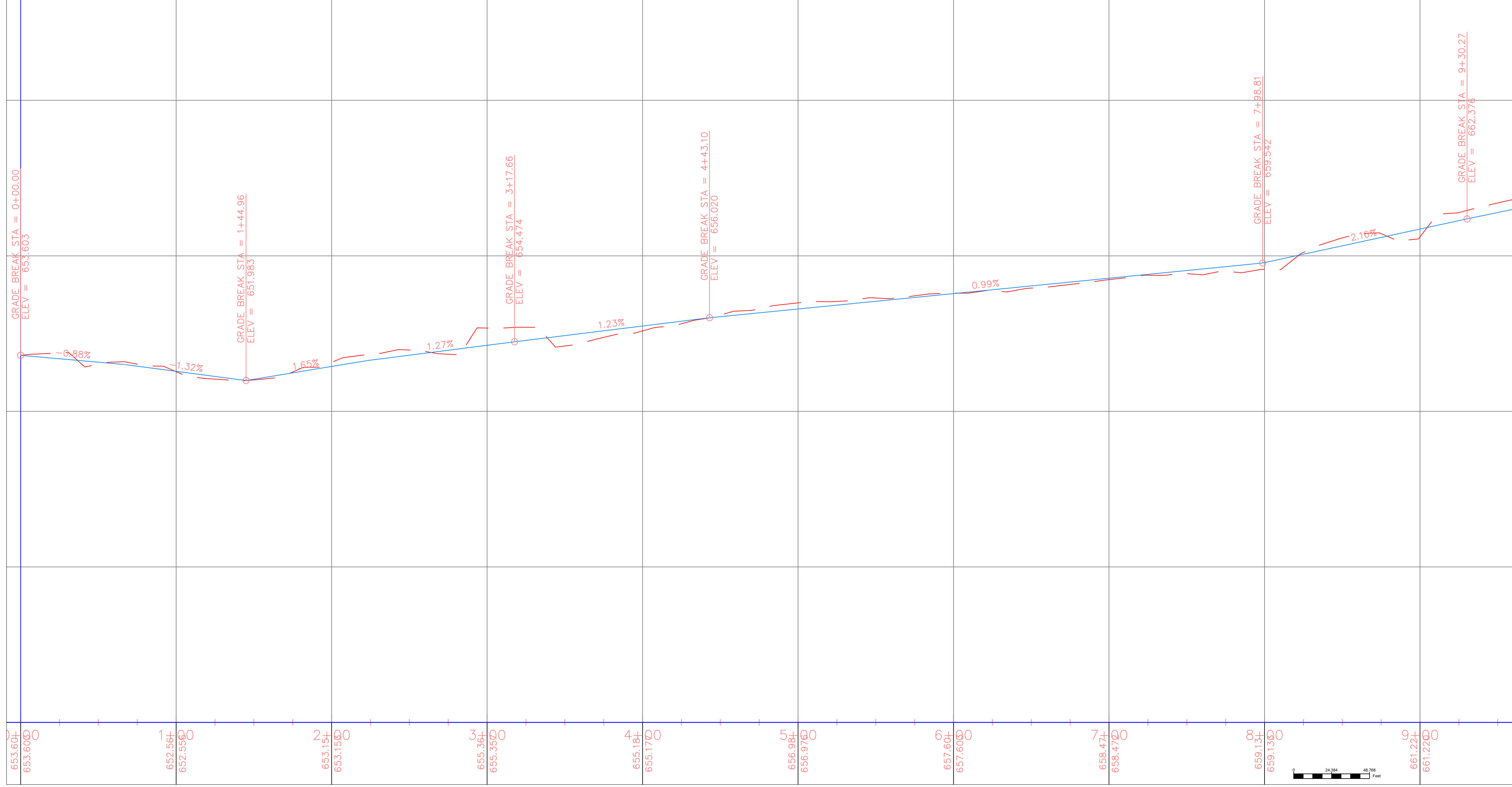

PROJECT:	CEE: 4850
DATE :	5-05-2022
DRAWN BY:	KB
REVISION:	

**THE UNIVERSITY OF IOWA**  
**CIVIL AND ENVIRONMENTAL ENGINEERING**  
 4105 SEAMANS CENTER FOR THE  
 ENGINEERING ARTS AND SCIENCES  
 103 S CAPITOL ST  
 IOWA CITY, IOWA 52242  
 PHONE: 319.335.5647  
 FAX: 319.335.5660  
 EMAIL: civil-hawks@iowa.edu

EDUCATIONAL - NOT FOR CONSTRUCTION

**Preston Connectivity**  
 City Of Preston  
 School St. Alternative 3 Pt 2

SHEET NAME  
 School St  
 Alternative 3 Pt 2

SHEET NO.  
**16**



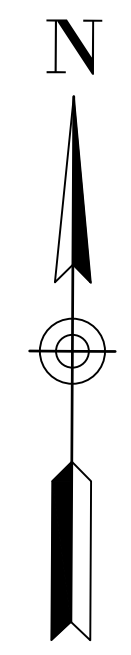
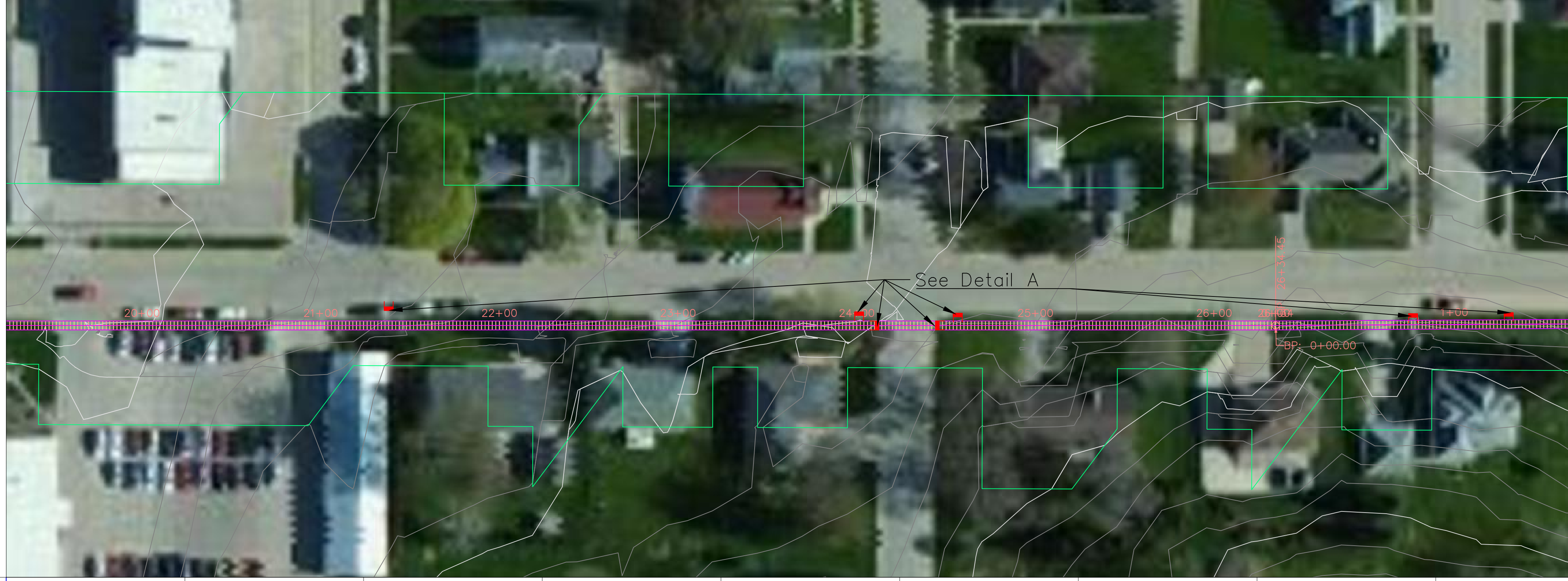
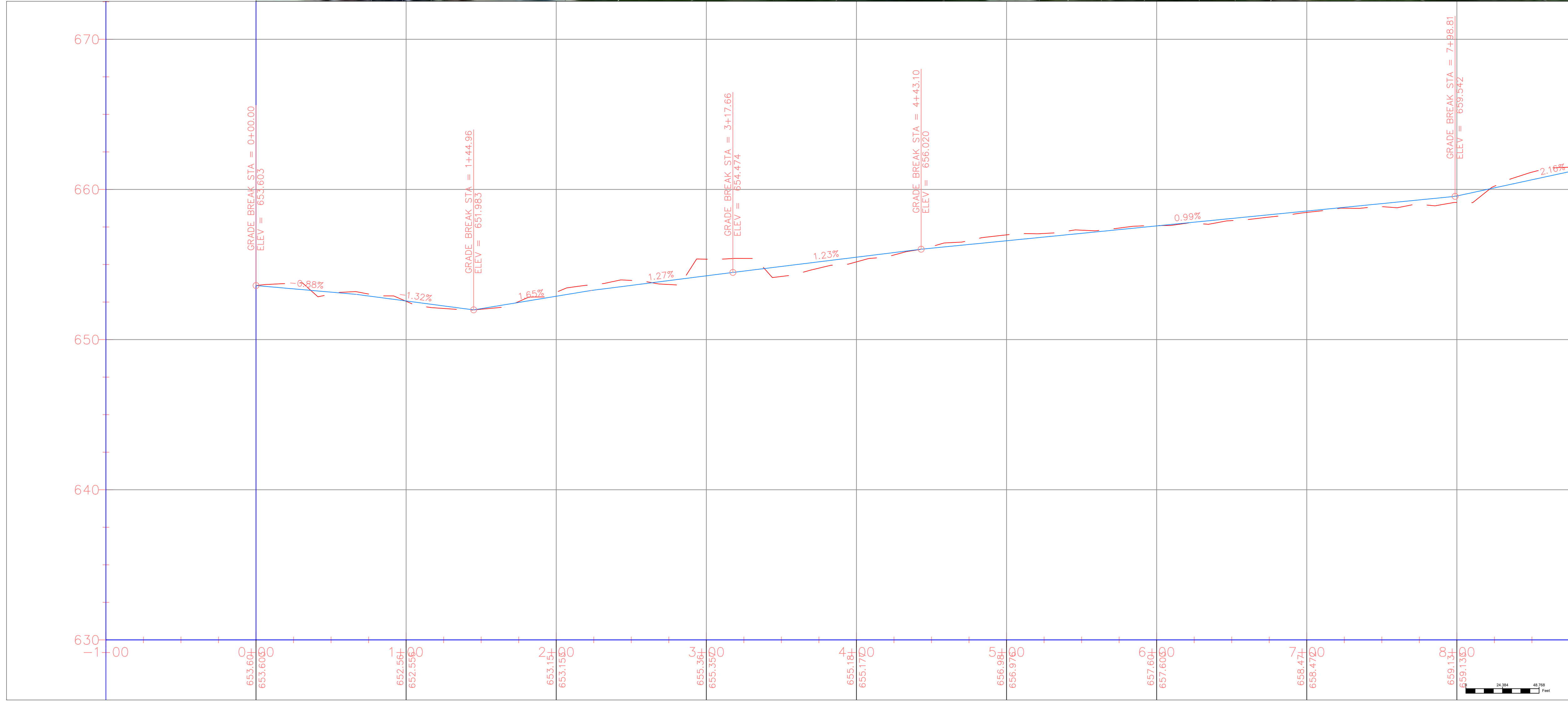

PROJECT:	CEE: 4850
DATE :	5-05-2022
DRAWN BY:	KB
REVISION:	

**THE UNIVERSITY OF IOWA**  
**CIVIL AND ENVIRONMENTAL ENGINEERING**  
 4105 SEAMANS CENTER FOR THE  
 ENGINEERING ARTS AND SCIENCES  
 103 S CAPITOL ST  
 IOWA CITY, IOWA 52242  
 PHONE: 319.335.5647  
 FAX: 319.335.5660  
 EMAIL: civil-hawks@iowa.edu

EDUCATIONAL - NOT FOR CONSTRUCTION

**Preston Connectivity**  
 City Of Preston  
 School St. Alternative 3 Pt 3

SHEET NAME  
 School St.  
 Alternative 3 Pt 3

SHEET NO.  
**17**

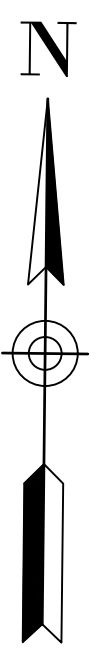
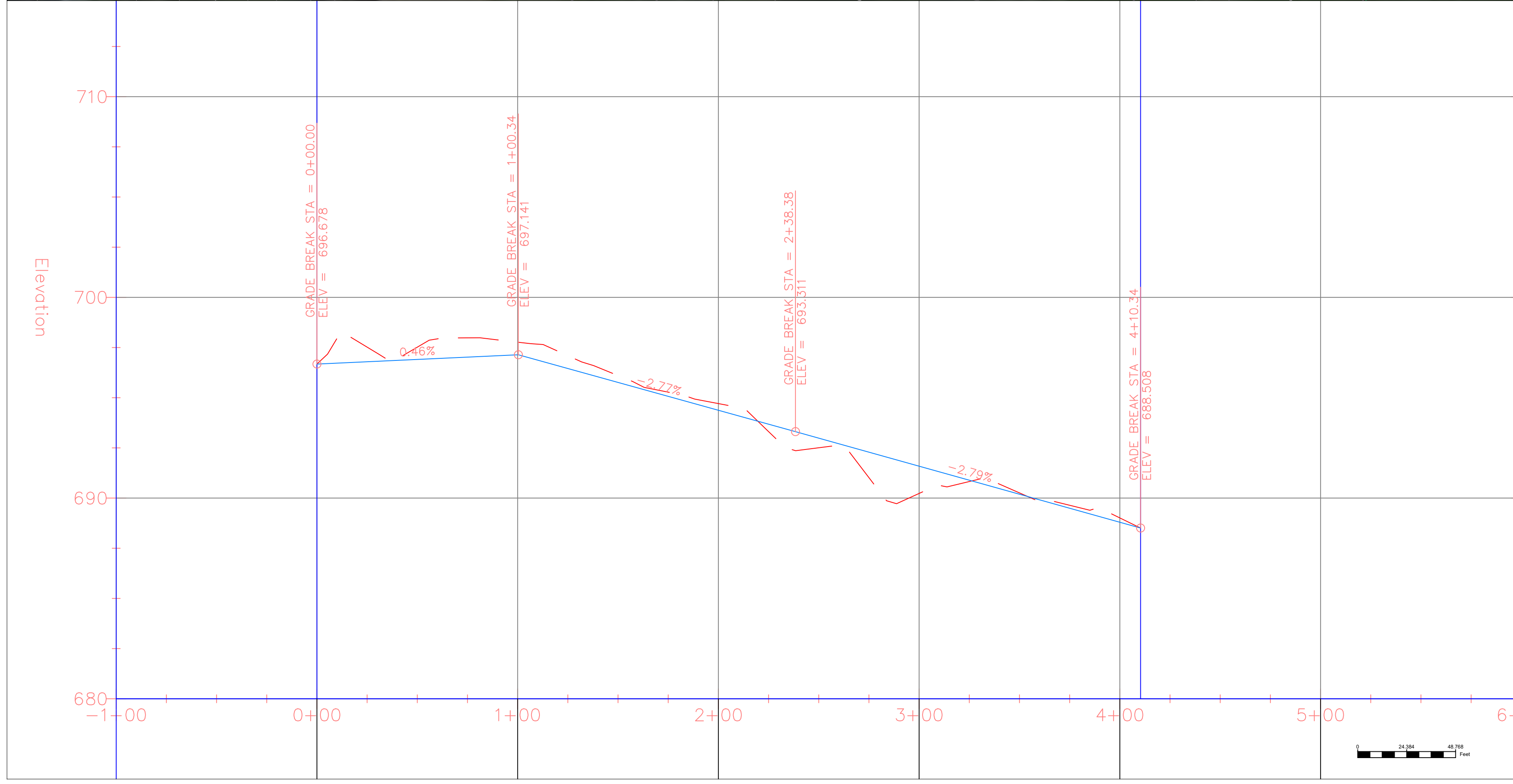

EDUCATIONAL - NOT FOR CONSTRUCTION

**Preston Connectivity**  
 City Of Preston  
 School St. Alternative 3 Pt 4

SHEET NAME  
 School St.  
 Alternative 3 Pt 4

SHEET NO.  
**18**

**IOWA CIVIL AND ENVIRONMENTAL ENGINEERING**  
 4105 SEAMANS CENTER FOR THE ENGINEERING ARTS AND SCIENCES  
 103 S CAPITOL ST  
 IOWA CITY, IOWA 52242  
 PHONE: 319.335.5647  
 FAX: 319.335.5660  
 EMAIL: [civil-hawks@iowa.edu](mailto:civil-hawks@iowa.edu)

**THE UNIVERSITY OF IOWA**  
 CIVIL AND ENVIRONMENTAL ENGINEERING

PROJECT: CEE: 4850  
 DATE: 5-05-2022  
 DRAWN BY: KB  
 REVISION:

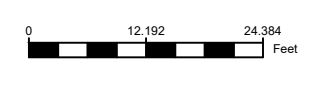
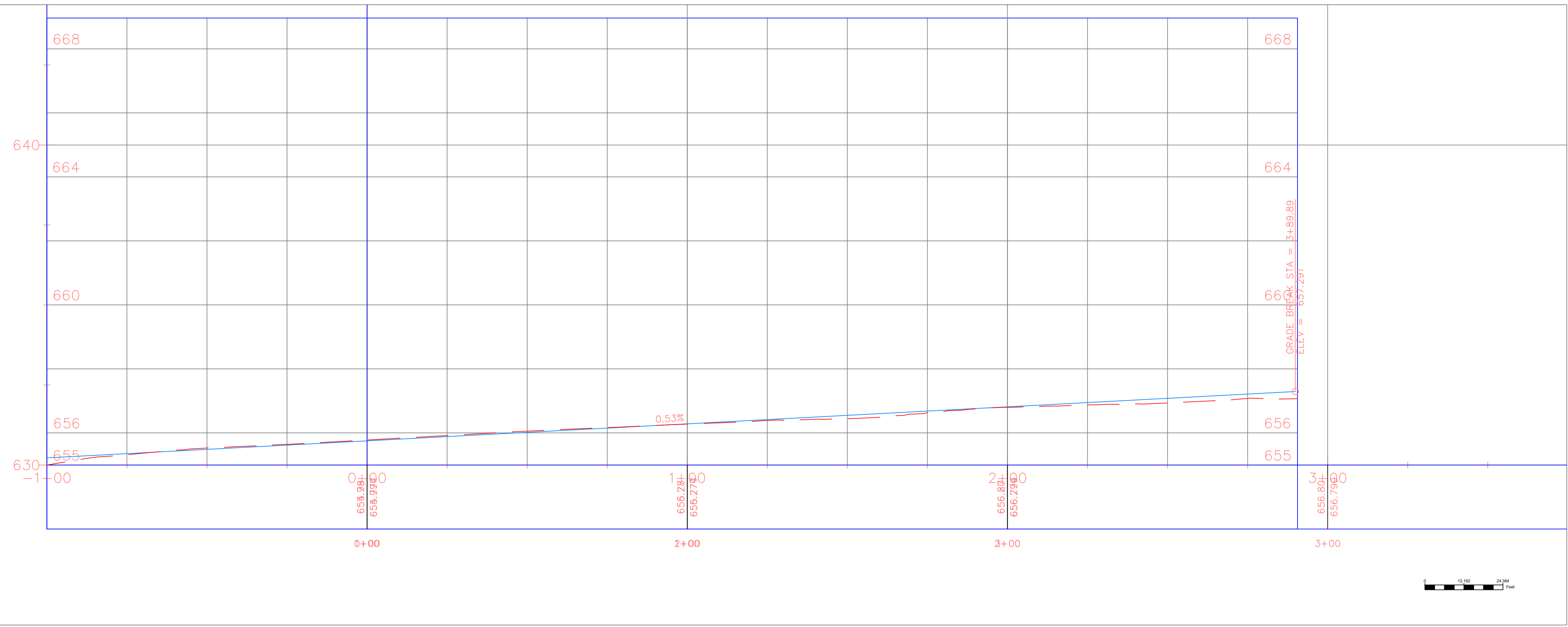
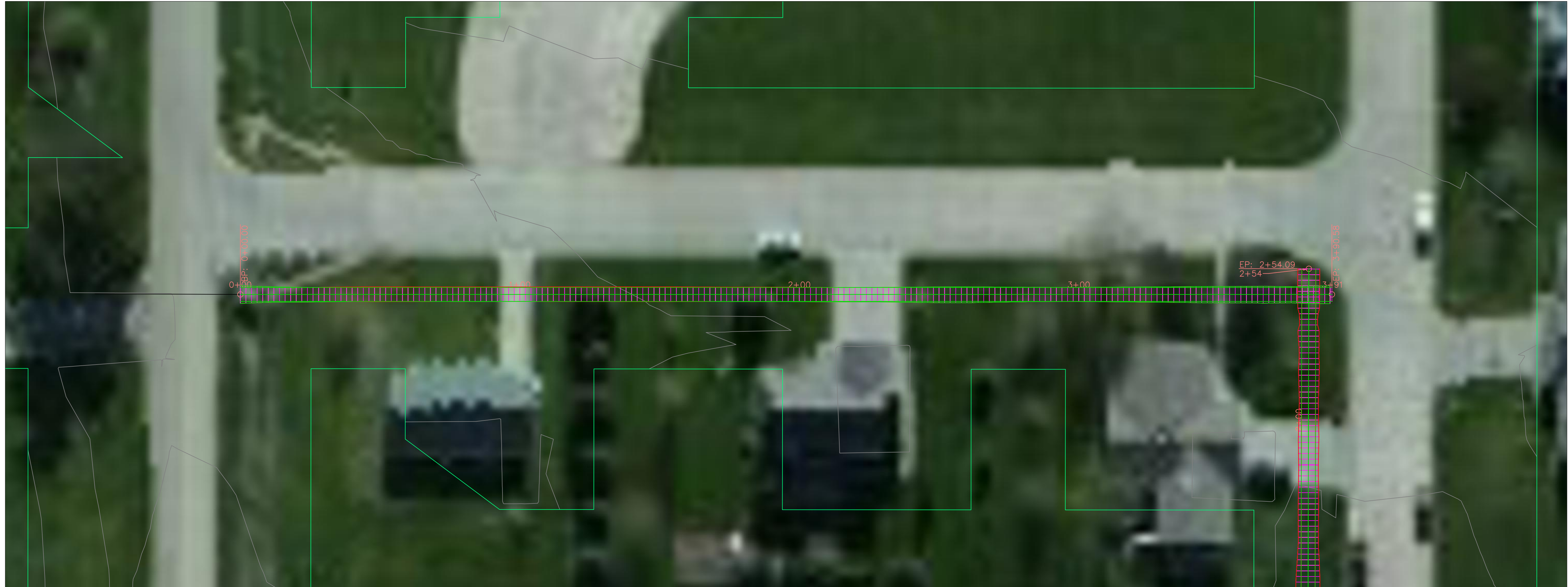
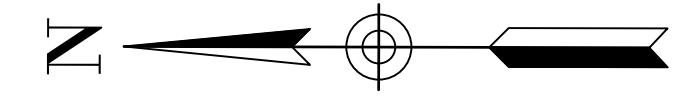

PROJECT:	CEE: 4850
DATE :	5-05-2022
DRAWN BY:	KB
REVISION:	

**THE UNIVERSITY OF IOWA**  
**CIVIL AND ENVIRONMENTAL ENGINEERING**  
 4105 SEAMANS CENTER FOR THE  
 ENGINEERING ARTS AND SCIENCES  
 103 S CAPITOL ST  
 IOWA CITY, IOWA 52242  
 PHONE: 319.335.5647  
 FAX: 319.335.5660  
 EMAIL: civil-hawks@iowa.edu



EDUCATIONAL - NOT FOR CONSTRUCTION

**Preston Connectivity**  
 City Of Preston  
 South-West Neighborhood Pt. 1

SHEET NAME  
 South West Dvlp  
 Pt 1

SHEET NO.  
**19**



See Detail A

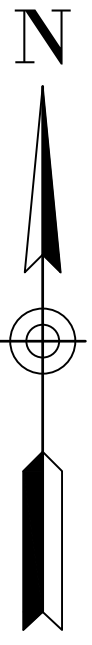
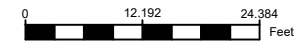
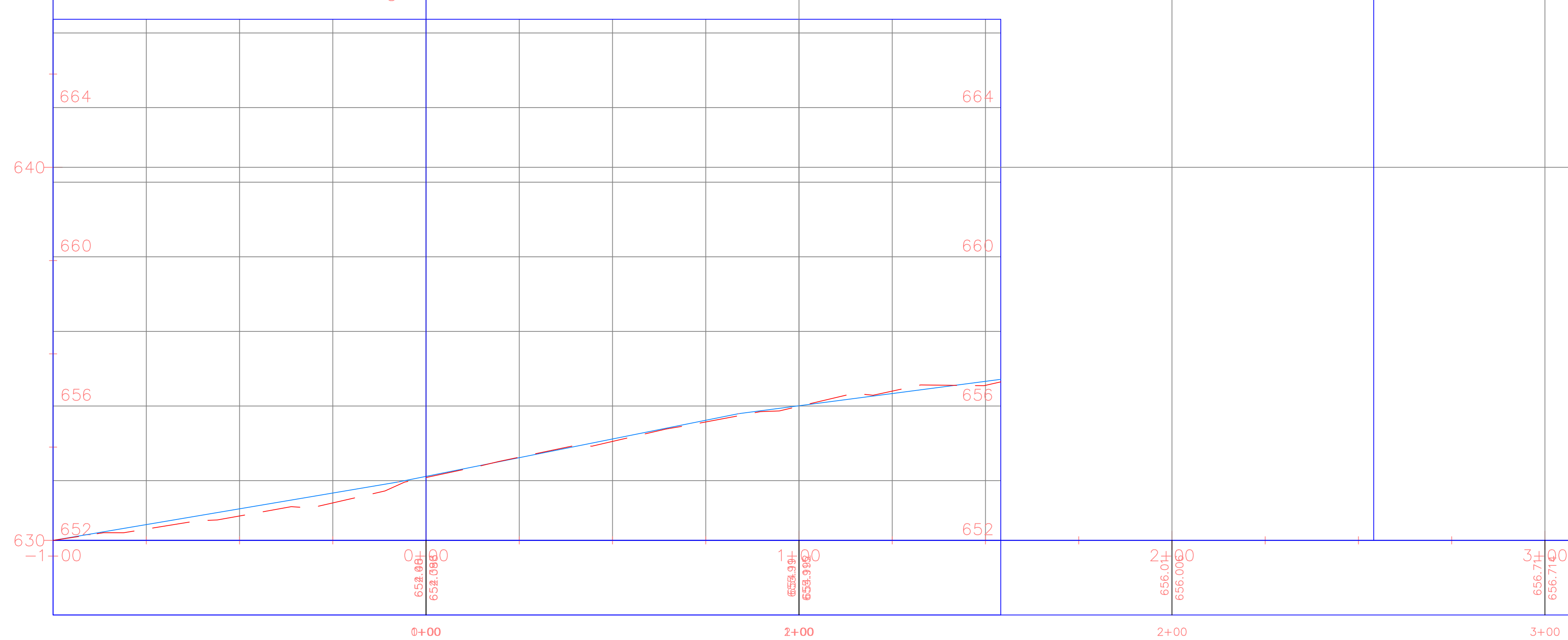

PROJECT:	CEE: 4850
DATE :	5-05-2020
DRAWN BY:	KB
REVISION:	

**THE UNIVERSITY OF IOWA**  
**CIVIL AND ENVIRONMENTAL ENGINEERING**  
 4105 SEAMANS CENTER FOR THE  
 ENGINEERING ARTS AND SCIENCES  
 103 S CAPITOL ST  
 IOWA CITY, IOWA 52242  
 PHONE: 319.335.5647  
 FAX: 319.335.5660  
 EMAIL: civil-hawks@iowa.edu



EDUCATIONAL - NOT FOR CONSTRUCTION

**Preston Connectivity**  
 City Of Preston  
 South West Neighborhood Pt. 2

SHEET NAME  
 South West Dvlp  
 Pt 2

SHEET NO.  
**20**

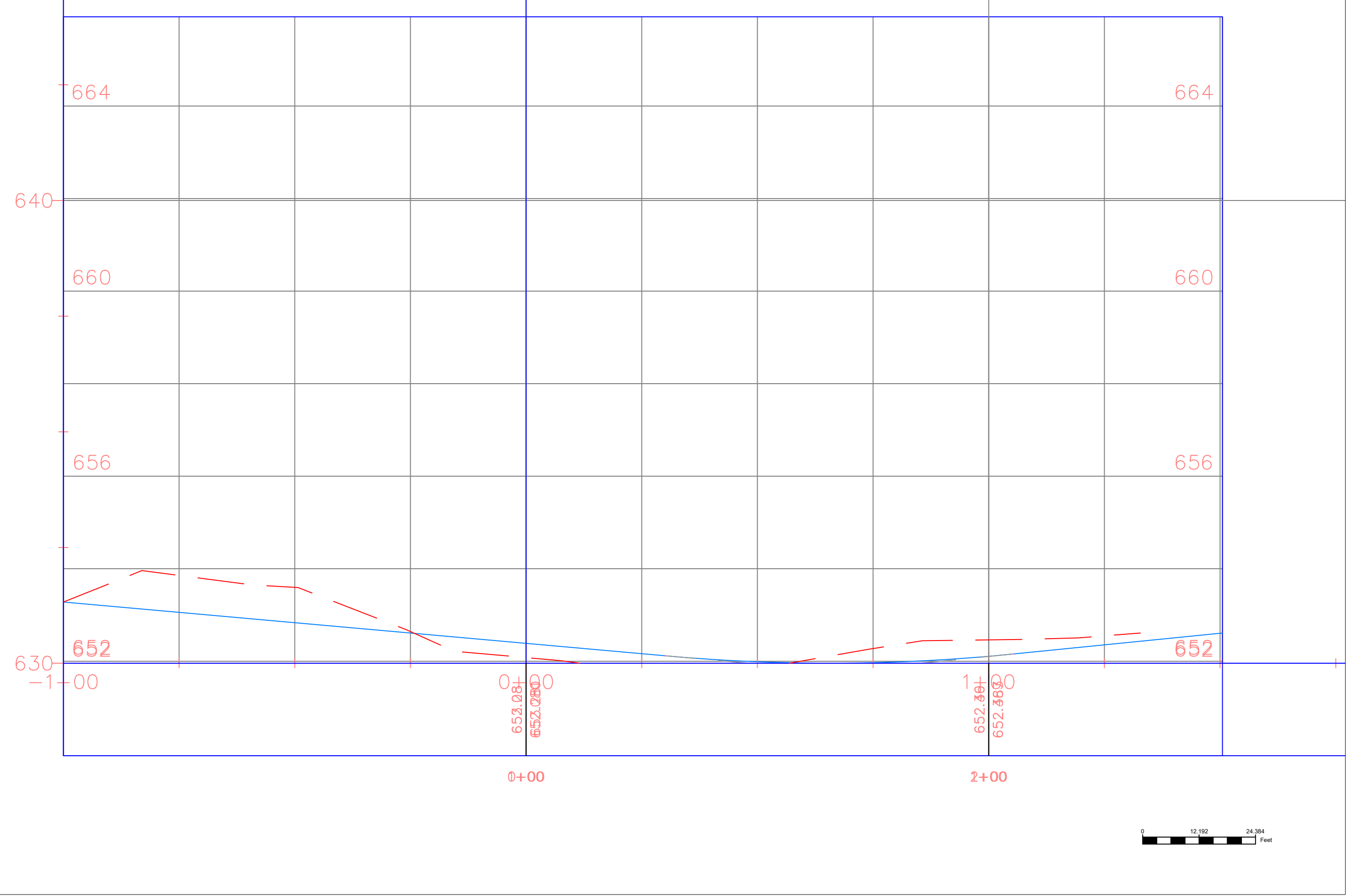

PROJECT:	CEE: 4850
DATE :	5-05-2022
DRAWN BY:	KB
REVISION:	

**THE UNIVERSITY OF IOWA**  
**CIVIL AND ENVIRONMENTAL ENGINEERING**  
 4105 SEAMANS CENTER FOR THE  
 ENGINEERING ARTS AND SCIENCES  
 103 S CAPITOL ST  
 IOWA CITY, IOWA 52242  
 PHONE: 319.335.5647  
 FAX: 319.335.5660  
 EMAIL: civil-hawks@iowa.edu



EDUCATIONAL - NOT FOR CONSTRUCTION

**Preston Connectivity**  
 City Of Preston  
 South West Neighborhood Pt. 3

SHEET NAME  
 South West Dvlp  
 Pt 3

SHEET NO.  
**21**

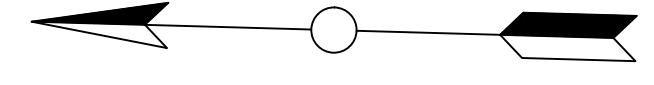

CC Horz Alt1 PROFILE

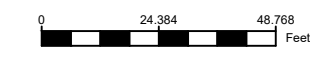
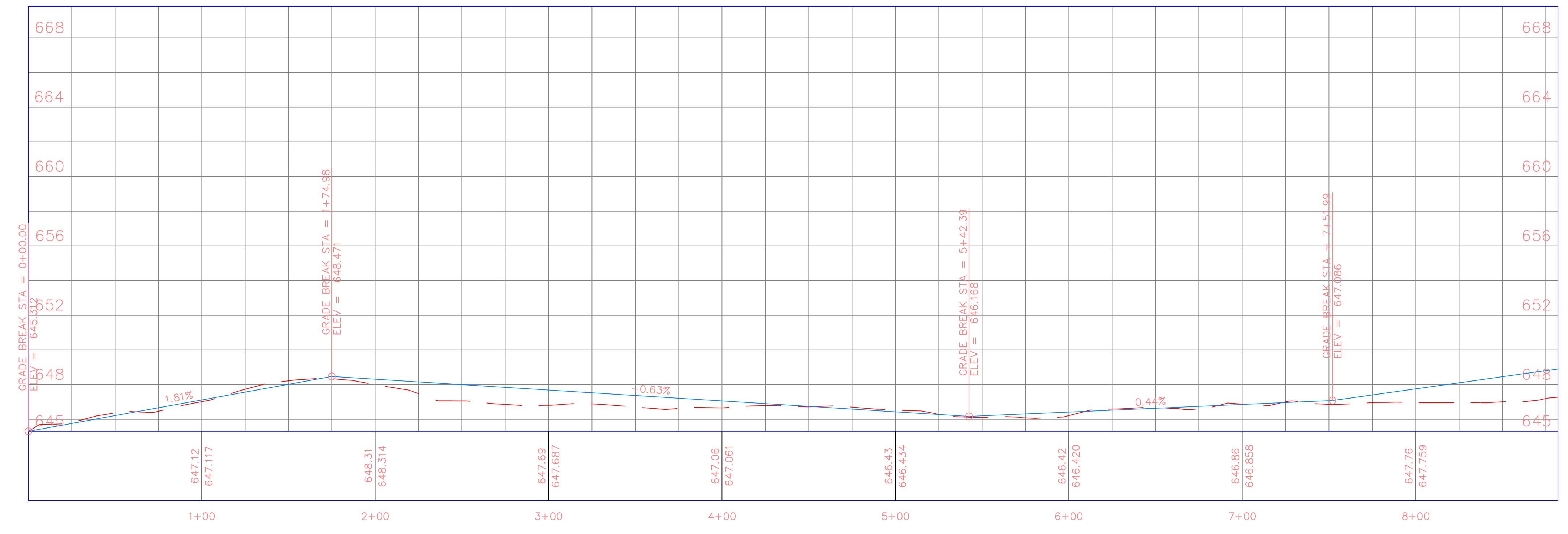

PROJECT:	CEE: 4850
DATE :	5-05-2022
DRAWN BY:	EF
REVISION:	

**THE UNIVERSITY OF IOWA**  
**CIVIL AND ENVIRONMENTAL ENGINEERING**  
 4105 SEAMANS CENTER FOR THE  
 ENGINEERING ARTS AND SCIENCES  
 103 S CAPITOL ST  
 IOWA CITY, IOWA 52242  
 PHONE: 319.335.5647  
 FAX: 319.335.5660  
 EMAIL: civil-hawks@iowa.edu

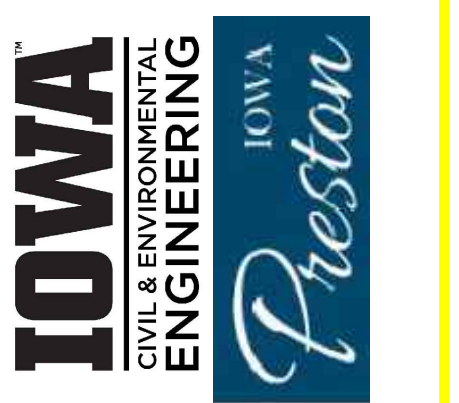

EDUCATIONAL - NOT FOR CONSTRUCTION

**Preston Connectivity**  
 City of Preston

SHEET NAME  
 Copper Creek Trail  
 Alternative 1

SHEET NO.  
**22**



CC Horz Alt1 PROFILE

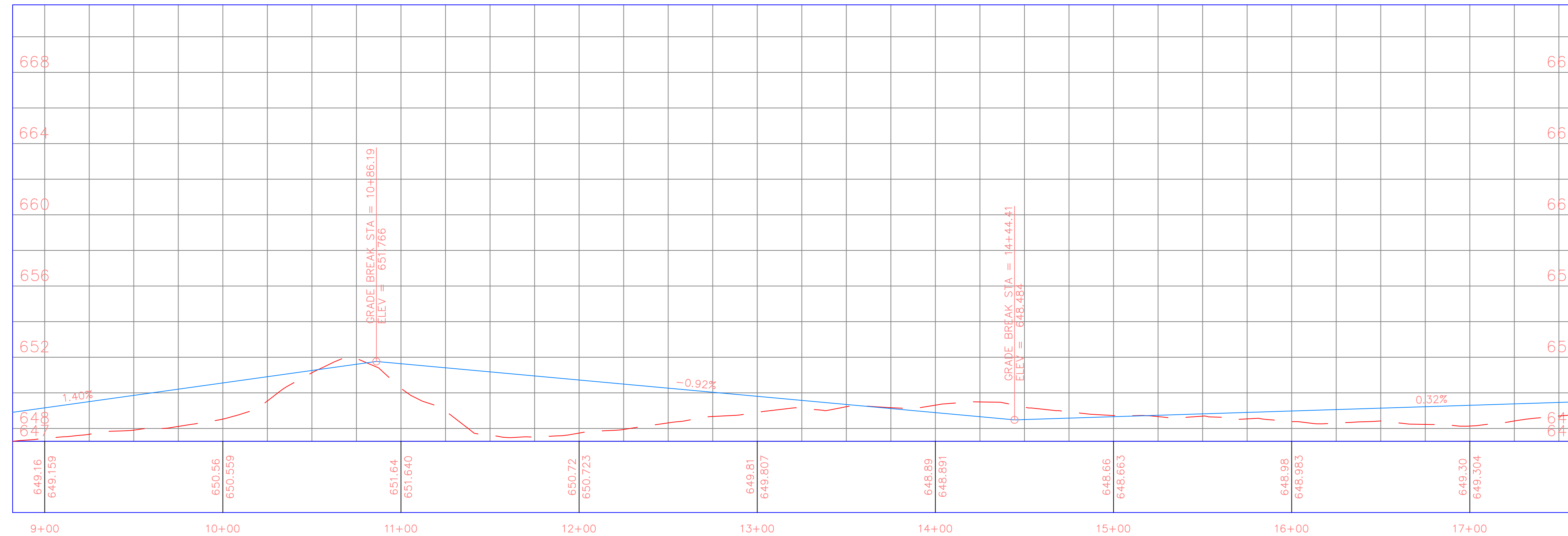

PROJECT:	CEE: 4850
DATE :	5-05-2022
DRAWN BY:	EF
REVISION:	

**THE UNIVERSITY OF IOWA**  
**CIVIL AND ENVIRONMENTAL ENGINEERING**  
 4105 SEAMANS CENTER FOR THE  
 ENGINEERING ARTS AND SCIENCES  
 103 S CAPITOL ST  
 IOWA CITY, IOWA 52242  
 PHONE: 319.335.5647  
 FAX: 319.335.5660  
 EMAIL: civil-hawks@iowa.edu



EDUCATIONAL - NOT FOR CONSTRUCTION

**Preston Conectivity**  
 City of Preston

SHEET NAME  
 Copper Creek Trail  
 Alternative 1

SHEET NO.  
**23**



CC Horz Alt1 PROFILE

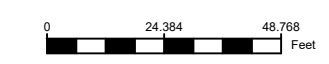
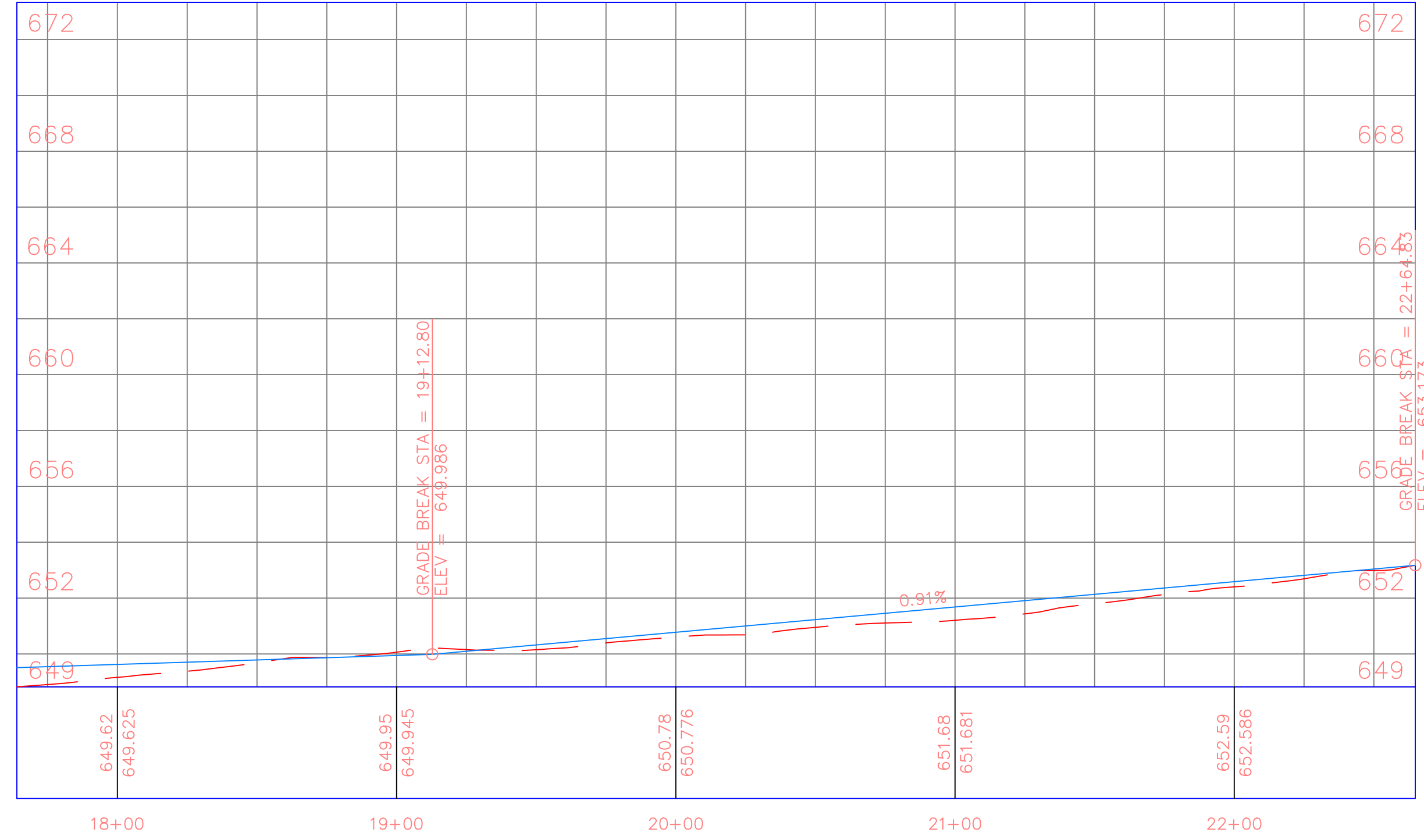

PROJECT:	CEE: 4850
DATE :	5-05-2022
DRAWN BY:	EF
REVISION:	

**THE UNIVERSITY OF IOWA**  
**CIVIL AND ENVIRONMENTAL ENGINEERING**  
 4105 SEAMANS CENTER FOR THE  
 ENGINEERING ARTS AND SCIENCES  
 103 S CAPITOL ST  
 IOWA CITY, IOWA 52242  
 PHONE: 319.335.5647  
 FAX: 319.335.5660  
 EMAIL: civil-hawks@iowa.edu

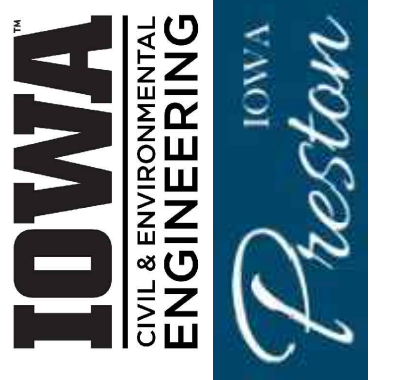

EDUCATIONAL - NOT FOR CONSTRUCTION

**Preston Conectivity**  
 City of Preston

SHEET NAME  
 Copper Creek Trail  
 Alternative 1

SHEET NO.  
**24**





CC Horz Alt 2 PROFILE

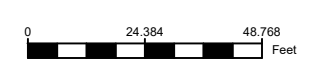
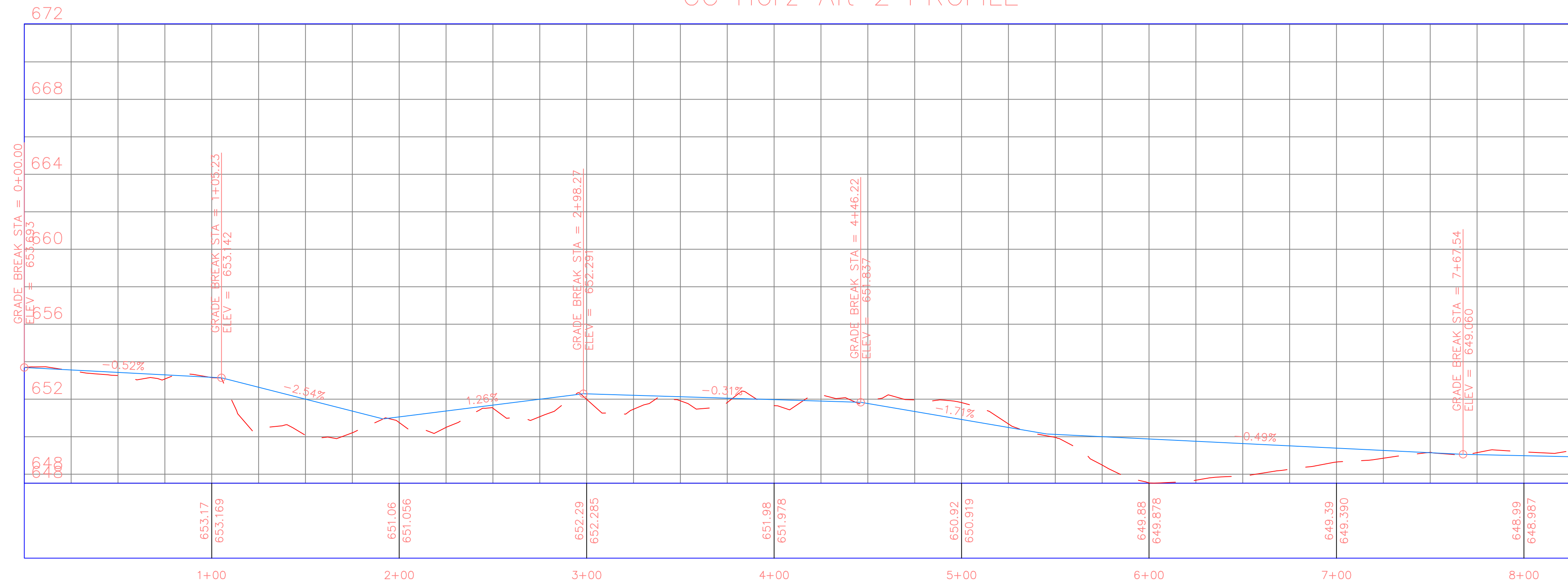

PROJECT:	CEE: 4850
DATE :	5-05-2022
DRAWN BY:	EF
REVISION:	

**THE UNIVERSITY OF IOWA**  
**CIVIL AND ENVIRONMENTAL ENGINEERING**  
 4105 SEAMANS CENTER FOR THE  
 ENGINEERING ARTS AND SCIENCES  
 103 S CAPITOL ST  
 IOWA CITY, IOWA 52242  
 PHONE: 319.335.5647  
 FAX: 319.335.5660  
 EMAIL: civil-hawks@iowa.edu



EDUCATIONAL - NOT FOR CONSTRUCTION

**Preston Connectivity**  
 City of Preston

SHEET NAME  
 Copper Creek Trail  
 Alternative 2

SHEET NO.  
**25**



CC Horz Alt 2 PROFILE

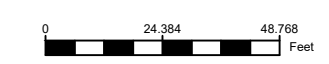
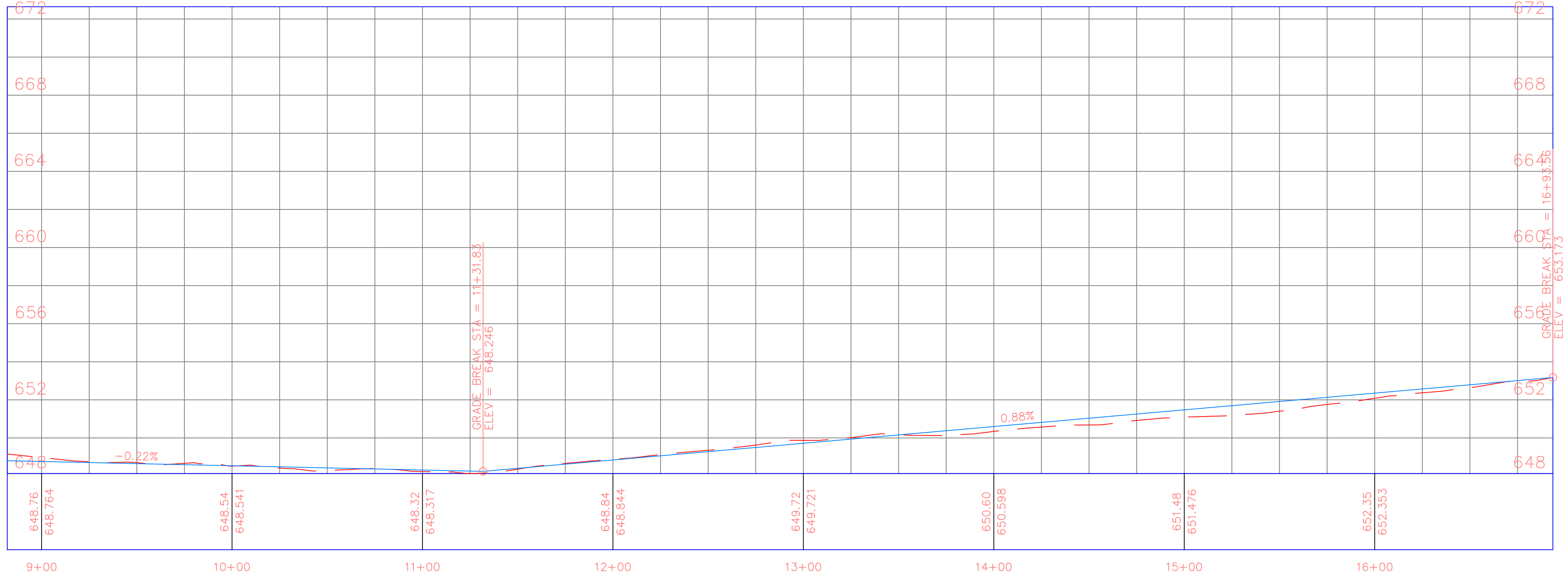

PROJECT:	CEE: 4850
DATE :	5-05-2022
DRAWN BY:	EF
REVISION:	

**THE UNIVERSITY OF IOWA**  
**CIVIL AND ENVIRONMENTAL ENGINEERING**  
 4105 SEAMANS CENTER FOR THE  
 ENGINEERING ARTS AND SCIENCES  
 103 S CAPITOL ST  
 IOWA CITY, IOWA 52242  
 PHONE: 319.335.5647  
 FAX: 319.335.5660  
 EMAIL: civil-hawks@iowa.edu

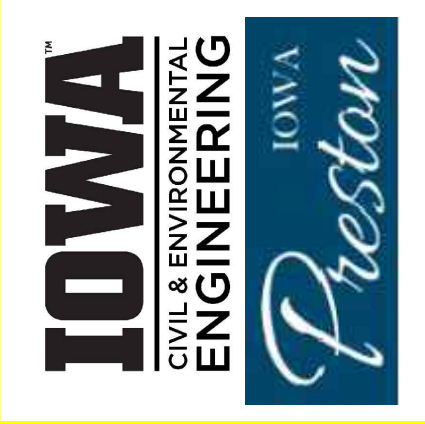

EDUCATIONAL - NOT FOR CONSTRUCTION

**Preston Conectivity**  
 City of Preston

SHEET NAME  
 Copper Creek Trail  
 Alternative 2

SHEET NO.  
**26**

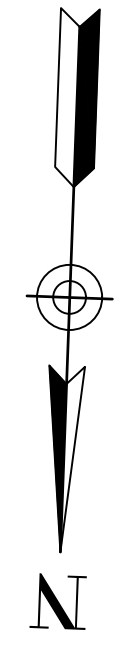

CC Horz Alt 3 PROFILE

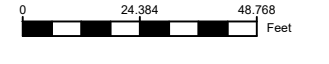
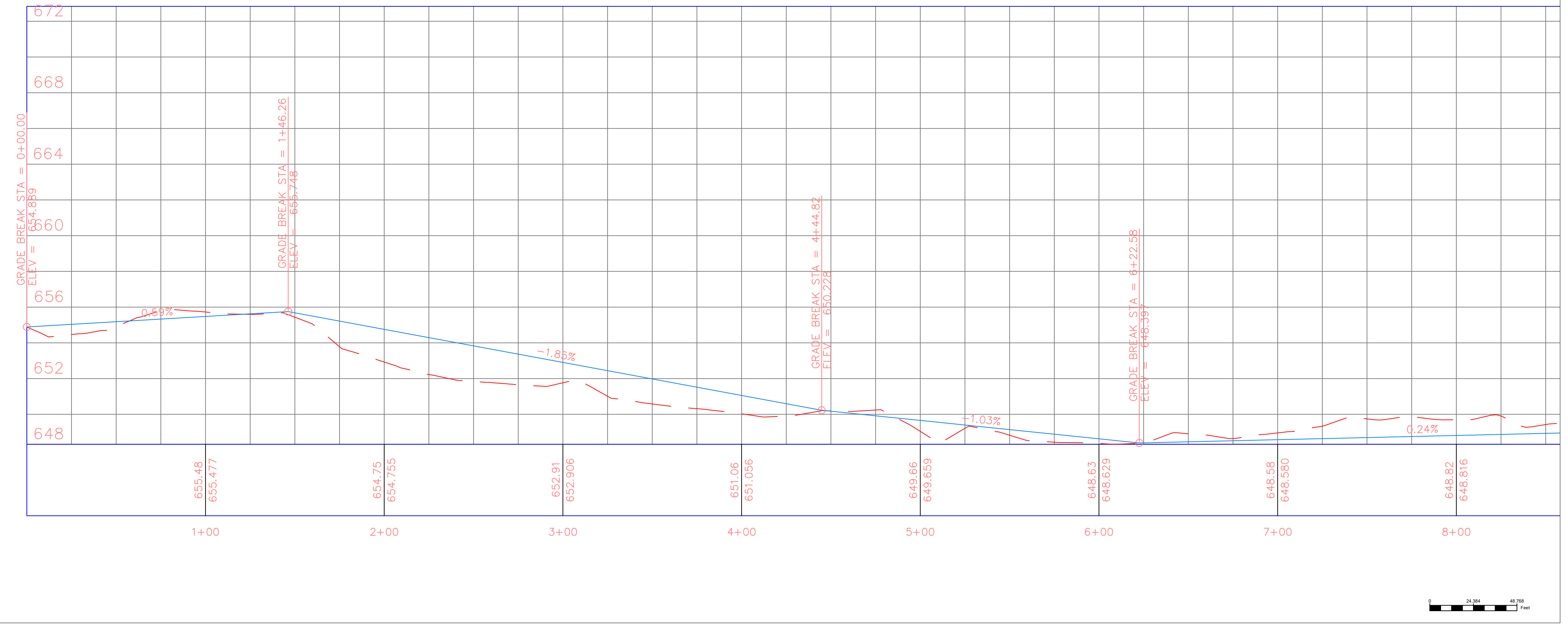

PROJECT:	CEE: 4850
DATE :	5-05-2022
DRAWN BY:	EF
REVISION:	

**THE UNIVERSITY OF IOWA**  
**CIVIL AND ENVIRONMENTAL ENGINEERING**  
 4105 SEAMANS CENTER FOR THE  
 ENGINEERING ARTS AND SCIENCES  
 103 S CAPITOL ST  
 IOWA CITY, IOWA 52242  
 PHONE: 319.335.5647  
 FAX: 319.335.5660  
 EMAIL: civil-hawks@iowa.edu

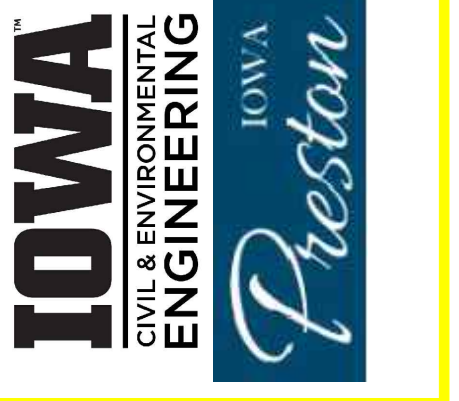

EDUCATIONAL - NOT FOR CONSTRUCTION

**Preston Connectivity**  
 City of Preston

SHEET NAME  
 Copper Creek Trail  
 Alternative 3

SHEET NO.  
**27**

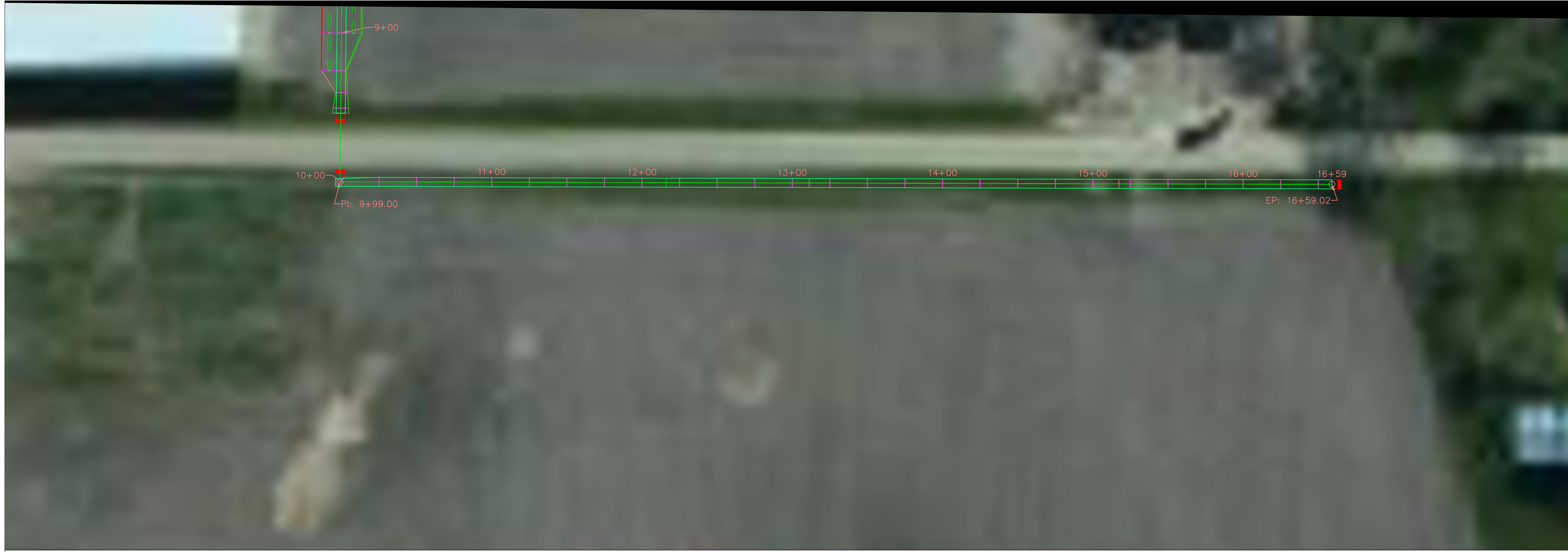

CC Horz Alt 3 PROFILE

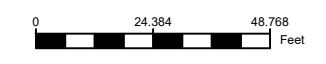
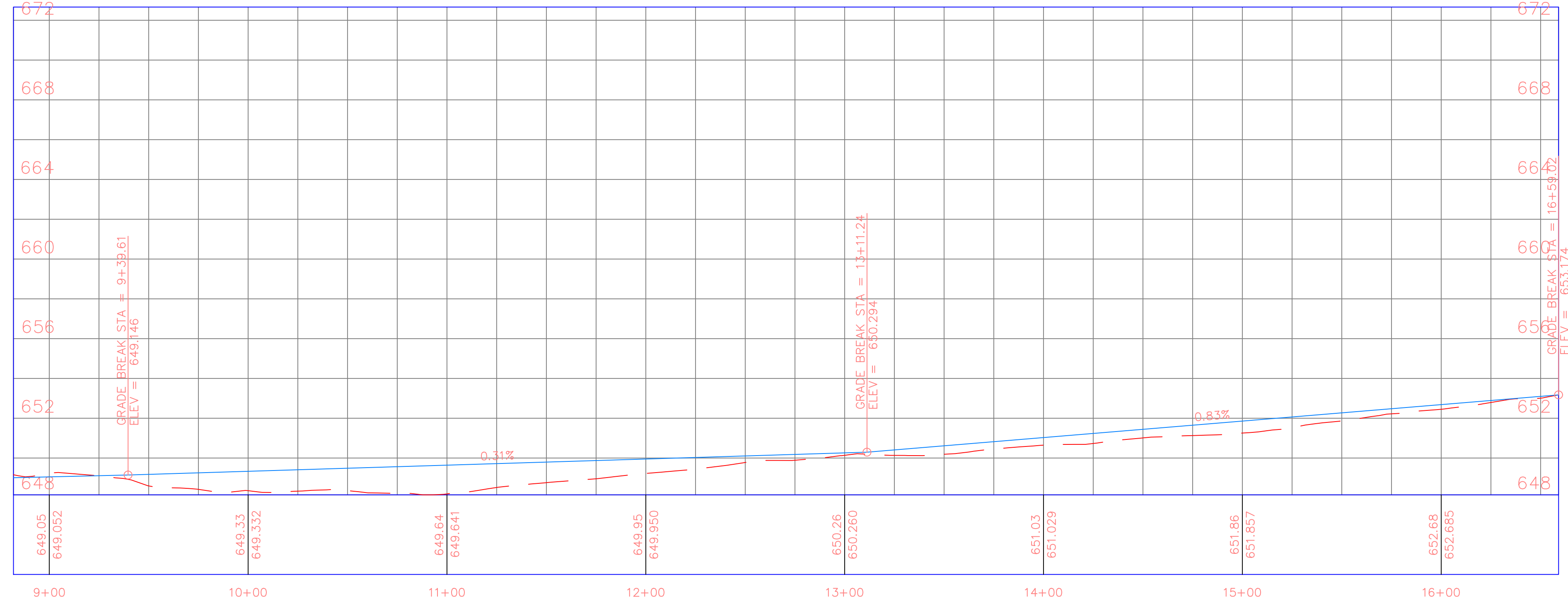

PROJECT:	CEE: 4850
DATE :	5-05-2022
DRAWN BY:	EF
REVISION:	

**THE UNIVERSITY OF IOWA**  
**CIVIL AND ENVIRONMENTAL ENGINEERING**  
 4105 SEAMANS CENTER FOR THE  
 ENGINEERING ARTS AND SCIENCES  
 103 S CAPITOL ST  
 IOWA CITY, IOWA 52242  
 PHONE: 319.335.5647  
 FAX: 319.335.5660  
 EMAIL: civil-hawks@iowa.edu

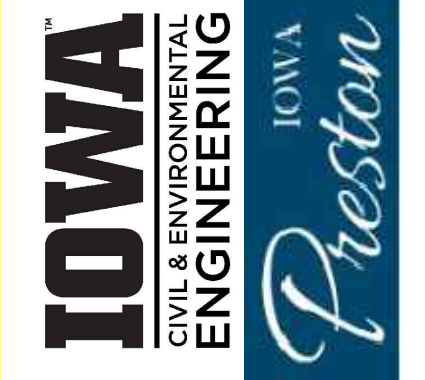

EDUCATIONAL - NOT FOR CONSTRUCTION

**Preston Connectivity**  
 City of Preston

SHEET NAME  
 Copper Creek Trail  
 Alternative 3

SHEET NO.  
**28**

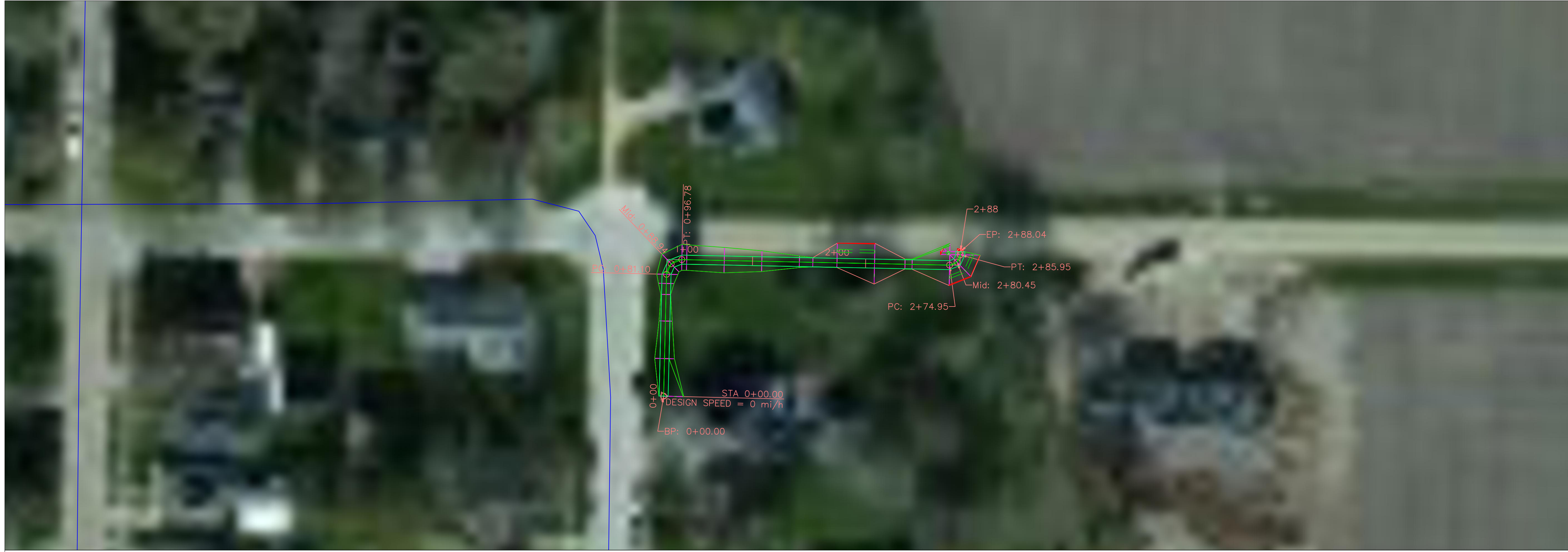

CC Horz Alt 4 PROFILE

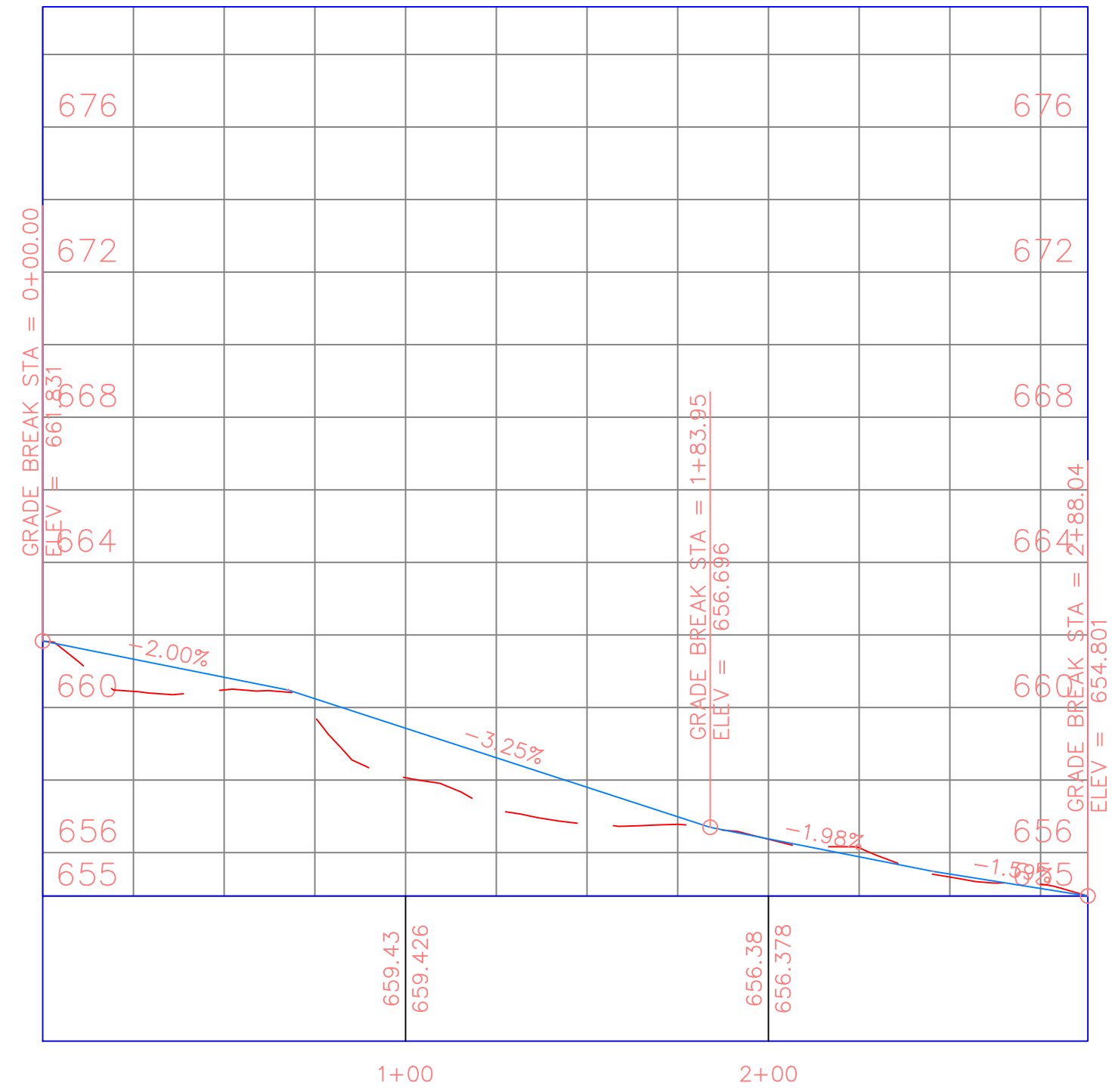

PROJECT:	CEE: 4850
DATE :	5-05-2022
DRAWN BY:	EF
REVISION:	

**THE UNIVERSITY OF IOWA**  
**CIVIL AND ENVIRONMENTAL ENGINEERING**  
 4105 SEAMANS CENTER FOR THE  
 ENGINEERING ARTS AND SCIENCES  
 103 S CAPITOL ST  
 IOWA CITY, IOWA 52242  
 PHONE: 319.335.5647  
 FAX: 319.335.5660  
 EMAIL: civil-hawks@iowa.edu



EDUCATIONAL - NOT FOR CONSTRUCTION

**Preston Connectivity**  
 City of Preston

SHEET NAME  
 Copper Creek Trail  
 Alternative 4

SHEET NO.  
**29**